



湖南艾华集团股份有限公司

HUNAN AIHUA GROUP CO., LTD

Tel: (0737)6184466 Fax : (0737)6180493

Http://www.aihuaglobal.com

客户Customer: 深圳市海宜通科技有限公司

日期Date: 2020年5月5日

承认书 SPECIFICATION

种 类: 固态铝电解电容器
Description: Aluminum Solid Electrolytic Capacitors
艾华料号 AISHI P/N: SVZ0JM471F8RE00RERF4
系 列 SERIES: VZ
规 格 尺 寸 ITEM: 6.3V470uF(Φ8*8.5)
客户料号 CustomerP/N: /
编 号No.: CRS-FX-2005008

批准 Approved by			客户确认 Client Confirmed	
制作 Prepared by	审核 Checked by	批准 Approved by	审核 Checked by	批准 Approved by

Please return one copy with your authorized signature when you accept these specifications.
Please note that no return within 6 months is considered to be approvable.

Starts	File Description	Component No./rev
Released	Approval Sheet- VZ	CRS-2020-VZ/01

1.概述Scope

此承认书使用于含有导电高分子电解质的VZ系列固态电解电容

These specifications specify VZ series of the Aluminum Solid Capacitors with Conductive Polymer Electrolyte.

2.使用温度范围Operating Temperature Range

使用温度范围是指电容在额定电压下可以稳定运行的环境温度范围

Operating temperature range is the range of ambient temperature at which the capacitor can be operated continuously at rated voltage.

-55~105℃(2.5V~100V)

3.特性Characteristics

除非另有说明，标准的测量和测试环境条件如下：

Unless otherwise specified, the standard range of atmospheric conditions for making measurements and tests are as follows.

环境温度Ambient temperature : 15 to 35℃

相对湿度Relative humidity: 45 to 85%

大气力压Air pressure: 86kpa to 106kpa

若对结果有疑问，测试则按如下标准进行

If there may be doubt on the results, measurements shall be made within the following limits.

环境温度Ambient temperature : 20±2℃

相对湿度Relative humidity: 60 to 70%

大气压Air pressure: 86kpa to 106kpa

4.额定电压、浪涌电压和额定温度Rated voltage, Surge voltage and Rated temperature

额定电压 Rated voltage(V)	额定温度 Rated temperature (℃)	浪涌电压 Surge voltage (V)	电压种类 Category voltage(V)
2.5	105	2.9	2.5
6.3	105	7.2	6.3
6.8	105	7.8	6.8
7	105	8.1	7
7.5	105	8.6	7.5
10	105	11.5	10
12	105	13.8	12
16	105	18.4	16
20	105	23.0	20
25	105	28.8	25
35	105	40.3	35
50	105	57.5	50
63	105	72.5	63
100	105	115.0	100

5. 高低温阻抗Impedance at high and low temperature

阻抗Impedance at 100kHz at -55±3℃ or 105±2℃

阻抗比Impedance ratio	性能Performance
$Z(-55^{\circ}\text{C}) / Z(+20^{\circ}\text{C})$	≤1.25
$Z(105^{\circ}\text{C}) / Z(+20^{\circ}\text{C})$	≤1.25

Issued-date:	Name	Approval Sheet				
2020-5-5	File No	VZ	Version	01	Page	3
STANDARD MANUAL						

Starts	File Description	Component No./rev
Released	Approval Sheet- VZ	CRS-2020-VZ/01

6.1 电性能Electrical Characteristics

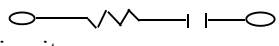
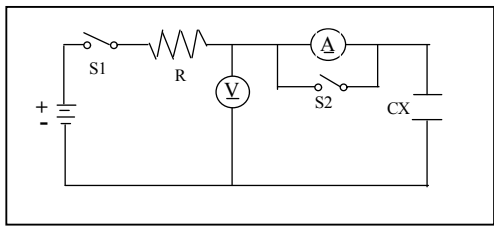
序号 No.	项目 Item	测试方法 Test method	性能 Performance
6.1.1	额定工作电压 Rated voltage	DC: 2.5V~100V	
6.1.2	电容量 Capacitance	测试频率Measuring frequency : 120Hz 测试电路Measuring circuit  等效串联电路Series equivalent circuit	参考特性表 Refer to characteristic table
6.1.3	损失角正切值 Dissipation Factor	测试电压Measuring voltage: 0.5Vrms or less 直流偏压DC bias voltage : +1.5~2.0VDC	参考特性表 Refer to characteristic table
6.1.4	等效串联电阻 ESR	测试频率Measuring frequency: 100kHz 测试温度Measuring temperature: 20 ±2℃ 测量位置: 不得超过导针焊点2mm。 Measuring point : 2mm max from the surface of a sealing resin on the lead wire	参考特性表 Refer to characteristic table
6.1.5	漏电流 Leakage current	直流漏电流在20℃, 有串联1000±100Ω电阻的情况下以直流工作电压且充电2min后测试 DC leakage current shall be measured after 2 minutes application of the DC rated working voltage through the1000 Ω resistor at 20℃  Refer to characteristic table R : 1000±100Ω A : 电流表 DC current meter S1 : 开关 Switch S2 : 电流表保护开关 Switch for protect of current meter V:电压表 DC voltage meter CX : 测试电容Testing capacitor	参考特性表 Refer to characteristic table

Issued-date:	Name	Approval Sheet				
2020-5-5	File No	VZ	Version	01	Page	4
STANDARD MANUAL						

Starts	File Description	Component No./rev
Released	Approval Sheet- VZ	CRS-2020-VZ/01

序号 No.	项目 Item	测试方法 Test method				性能 Performance
6.1.6	高温&低温性 Characteristics at Hight Temperature & Low Temperature					Step 1:容量、损失角在规格值内 Capacitance,tanδ shall meet the specified value
		步骤 Step	温度(°C) Temperature	时间 (h) Time	测试项目 Measurement item	Step 2:容差±10% Capacitance change :Within±10% of step1
		1	20±2	2	容量、损失角正切、阻抗 Capacitance,tanδ, Z	阻抗比率小于1.25 Z (-55°C) / Z (20°C) Less than 1.25
		2	-55±3	2	容量、阻抗 Capacitance, Z	
		3	20±2	0.5		Step 4: 漏电小于0.2CV值或500μA 中的任一个较大值的150%
		4	105±2	2	阻抗、漏电 Z ,LC	Leakage current≤ 150% of the larger values between 0.2CV and 500uA.
		5	20±2	2	容量、损失角正切 Capacitance,tanδ	阻抗比率小于1.25 Z (105°C) / Z (20°C) Less than 1.25
		备注Remarks: 120Hz: Capacitance,tanδ 100KHz: Z ,ESR				Step 5: 容差±5% Capacitance change :Within±5% of step1 损失角在规格值内 tanδ shall meet the specified value.
6.1.7	浪涌电压 Surge voltage	额定浪涌电压充电30秒后，在室温下放电330秒。这一过程要重复1000次，每一次循环的时间为6分钟，测试温度为15°C-35°C。 Rated surge voltage shall be applied (switch on) for 30 seconds and then shall be applied (switch off) with discharge for 330 seconds at room temperature . This cycle shall be repeated for 1000 cycles . Duration of one cycle is 6 minutes . Test temperature: 15°C-35°C				漏电流≤0.2CV值或500μA中的任一个较大值 Leakage current≤ the larger values between 0.2CV and 500uA. 容量改变在初始值的±20%内 Capacitance change Within±20% of the initial value 损失角≤规格值的150% tanδ≤150% of the initial value. 等效串联电阻≤规格值的150% ESR≤150% of the initial specified value.

Issued-date:	Name	Approval Sheet				
2020-5-5	File No	VZ	Version	01	Page	5
STANDARD MANUAL						

Starts	File Description	Component No./rev	
Released	Approval Sheet- VZ	CRS-2020-VZ/01	
序号 No.	项目 Item	测试方法 Test method	性能 Performance
6.2.1	振动试验 Resistance to Vibration	依照JIS C 5102 8.2和 JIS C 5025 To comply with JIS C 5102 8.2 and JIS C 5025 频率: 10到55Hz(1分钟间隔/10→55→10Hz) Frequency: 10 to 55Hz (1 minute interval/10→55→ 10Hz) 振幅: 0.75mm(整体偏移1.5mm) Amplitude : 0.75mm (Total excursion 1.5mm) 方向: X, Y, Z (3 轴) Direction : X , Y , Z (3 axes) 持续时间: 2小时/轴 (共6小时) Duration : 2 hours / axial (Total 6 hours)	容量在30分钟内测量, 与初始值相比不应有较大的差异, 其改变在±5%以内 Capacitance value should not show drastic change compared to the initial capacitance when the value is measured within 30 minutes.Prior to the completion of exam, capacitance change should be within ±5% compared to the initial value after the exam 外观: 导针不得断裂 Appearance:Don't lead wire broken
6.2.2	可焊性Solder ability	温度: 235 ± 5 °C Temperature : 235 ± 5 °C 持续时间: 2 ± 0.5秒 Duration : 2 ± 0.5 seconds 焊料:25wt%的松香(JIS K5902)//乙醇(JIS K 8101) Flux:Rosin (JIS K5902)//Ethanol(JIS K8101); About 25 wt.%	至少95%的浸渍表面覆盖有新的焊料 At least 95% of surface area of the dipped portion of the terminal shall be covered with new solder.

6.3 耐受能力Endurance Performance

序号 No.	项目 Item	测试方法 Test method	性能 Performance
6.3.1	耐焊接热Resistance to soldering heat	测试条件Test condition (1)汽相焊接的方法: 焊膏用于印刷电路板上后, 再安装电容器, 电容器应保持在气相液260±5°C的温度下10±1秒。 Vapor phase soldering method: Solder paste should be applied to the printed wiring boards and then the capacitors are mounted on it. After that, the capacitor should be maintained in the vapor phase bath at a temperature of 260 ± 5 °C for 10 ± 1 seconds. (2)焊接方法Soldering iron method: 温度Temperature: 400 ± 10 °C 持续时间Duration: 3+1/-0seconds	容量变化在初始值的±5%内 Capacitance change: Within ± 5% of initial capacitance 损失角≤规格值的130% Tanδ≤130%of the initial specified value. 等效串联电阻≤规格值的130% ESR ≤ 130% of the initial specified value. 漏电流≤0.2CV值或500μA中的任一个较大值 Leakage current≤ the larger values between 0.2CV and 500uA.
6.3.2	稳态湿热 (恒稳态) Resistance to damp heat (steady state)	温度Temperature : 60±2°C 相对湿度Relative humidity : 90% ~ 95% 持续时间Duration : 1000 (-0/+48) hrs 使用电压: 无负荷 Applied voltage : without load	电容变化在初始值的±20%内 Capacitance change within ±20% of initial value 损失角≤规格值的150% tan δ ≤ 150% of the initial specified value. 等效串联电阻≤规格值的150% ESR ≤ 150% of the initial specified value. 漏电流≤0.2CV值或500μA中的任一个较大值 Leakage current≤ the larger values between 0.2CV and 500uA.

Issued-date:	Name	Approval Sheet				
2020-5-5	File No	VZ	Version	01	Page	6
STANDARD MANUAL						

Starts	File Description	Component No./rev
Released	Approval Sheet- VZ	CRS-2020-VZ/01

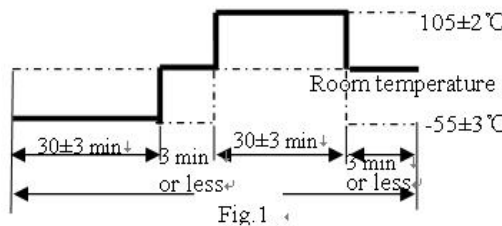
序号 No.	项目 Item	测试方法 Test method	性能 Performance
6.3.3	快速变温 Rapid change of temperature	 <p>使用电压：无负荷 Applied voltage : without load 循环次数：10次 Cycle number : 10 Cycles 测试图:Fig. 1 Test diagram: Fig. 1</p>	容量变化：在初始值的±10%内 Capacitance change : Within ±10% of the initial capacitance 损失角：小于或等于规格值 tanδ ≤ initial specified value. 漏电流≤0.2CV值或500μA中的任一个较大值 Leakage current ≤ the larger values between 0.2CV and 500uA.
6.3.4	负荷寿命试验 Load Life Test	电容在105±2°C,加载直流电2000小时后，需在室温下放置2小时才可进行测试 After 2000hours continuous application of DC rated working voltage at 105 ± 2°C,the measurements shall be measured after 2 hours exposed at room temperature	容量变化：在初始值的±20%内 Capacitance change within ±20% of the initial value 损失角：小于规格值的150% tan δ ≤ 150% of the initial specified value. 等效串联电阻≤规格值的150% ESR ≤ 150% of the initial specified value. 漏电流≤0.2CV值或500μA中的任一个较大值 Leakage current ≤ the larger values between 0.2CV and 500uA. 外观：没有明显的损伤 Appearance:No significant damage

备注 REMARKS

如果有任何疑问，在电压处理后测量漏电流。

电压：直流额定电压适用于电容器在105℃下120分钟。

需在室温下放置2小时才可进行测试

If any doubt arises, measure the leakage current after following voltage treatment.

Voltage treatment : DC rated voltage are applied to the capacitors for 120 minutes at 105℃.

The measurements should be measured after 2 hours exposed at room temperature

Issued-date:	Name	Approval Sheet				
2020-5-5	File No	VZ	Version	01	Page	7
STANDARD MANUAL						

Starts	File Description	Component No./rev
Released	Approval Sheet- VZ	CRS-2020-VZ/01

7.物料编码PART No. SYSTEM

S	VZ	0J	M	471	F8R	E00	R	ERF4
---	----	----	---	-----	-----	-----	---	------

- 特殊编码 Special code(7.9)
- 捺印编码Marking code(7.8)
- 成型方式编码Terminal code(7.7)
- 尺寸编码Size code(7.6)
- 电容量编码Capacitance Code(7.5)
- 电容公差Capacitance tolerance (7.4)
- 电压编码Voltage Code(7.3)
- 系列编码Series Code(7.2)
- 类别编码Category Code(7.1)

7.1 类别编码Category Code

编码Code	S
类别编码Category Code	固态电容Solid Capacitor

7.2 系列编码Series Code

编码Code	VZ
系列编码Series Code	VZ

7.3 电压编码Voltage Code

编码Code	0E	0J	1D	1E	1H	1B	1K
电压编码VoltageCode(W.V)	2.5	6.3	20	25	50	80	100

7.4 电容公差Capacitance tolerance

“M”代表 -20% ~ +20 % “M”stands for -20% ~ +20 %

7.5 电容量编码Capacitance Code

编码Code	470	181	331	471	561	681	821	152
电容量Capacitance (uF)	47	180	330	470	560	680	820	1500

7.6 尺寸编码Size Code

编码Code	D08	B09	E06	E09	E11	F8R	FBR	GCR	K18
直径D (Φ)	5	5.5	6.3	6.3	6.3	8	8	10	13
高度H (mm)	8	9	6	9	11	8.5	11.5	12.5	18

7.7 成型方式编码 Terminal Code

编码Code	D00	E00
其他 Other	贴片、散装SMD&Bulk	贴片、编带SMD&Taping

7.8 捺印编码Marking Code

编码Code	S	R
捺印Marking	天蓝Sky blue	红色Red

7.9 特殊编码 Special Code

“ERF4” “ER” 代表ESR、RC特殊，“F”代表ESR为15mΩ。“4”代表纹波电流为4000mA。
“ER” stands for special ESR&RC.“F”stand for ESR max is 15mΩ.“4”stand for RC is 4000mA.

Issued-date:	Name	Approval Sheet				
2020-5-5	File No	VZ	Version	01	Page	8
STANDARD MANUAL						

Starts	File Description	Component No./rev
Released	Approval Sheet- VZ	CRS-2020-VZ/01

8. 结构Construction

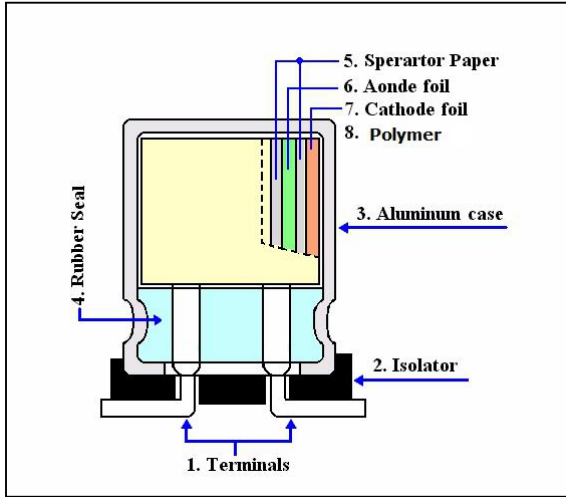

导线：镀锡钢线

Lead wires : Tinned Steel wires (Silver-plated)

导线端子：高纯铝Terminals : High pure aluminum

电解纸：马尼拉麻Paper : Manila hemp

铝箔（正极）：高纯铝

Al-foil (Anode) : High pure aluminum

铝箔（负极）：碳箔Al-foil (Cathode) : Carbon foil

镀膜铝壳：铝+镀膜（耐压600V以上）

Coating AL-case:Aluminum+coating(Can withstand voltage above 600V)

胶带：聚酯Tape : Polyester

胶粒：(树脂)压缩成型IIR-Rubber:Resin (Compression molding)

导线和圆柱端子通过焊接连接在一起

The lead wire and the Al-boss are welded together.

导线扁平端子与铝箔通过按压连接在一起

The Al-tab and the Al-foil are stitched to join together.

卷绕的素子外部以阴极箔包裹

The outer most Al-foil spiral of the element is cathode.

导电高分子用作电解质

Conductive polymer is used as the electrolyte.

Isolator :PPS

9.规格尺寸图 Dimensions.

尺寸Outer dimensions (单位Unit:mm)

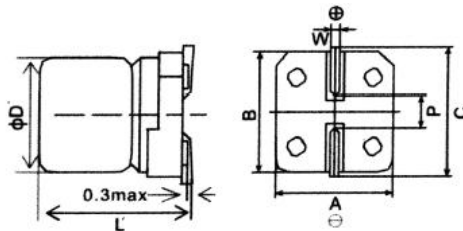

尺寸编码 Size Code	ΦD (mm)	ΦD(mm) Tolerance	L' (mm)	L'(mm) Tolerance	A±0.2 (mm)	B±0.2 (mm)	C±0.2 (mm)	P±0.2 (mm)	W (mm)
F8R	8	-0.1~+0.5	8.5	-0.3~+0.5	8.3	8.3	9	3.1	0.9±0.2

10. 特性表格Characteristics Table

序号 N o.	艾华料号 AISHI P/N	额定 工作电压 Rated Work Voltage (V.DC)	电容量 Nominal Capacitance 120Hz,20°C (μF)	电容量 公差 Capacitance Tolerance (%)	温度 Oper Temp (°C)	尺寸 Nominal Case Size D*L (mm)	等效 串联电阻 E.S.R 100KHz 20°C (mΩmax)	最大漏电流 Leakage current 20°C(μA max) 1Minutes/W.V	损失 D.F 120Hz, 20°C (%max)	纹波电流 Ripple Current 100KHz,105°C (mA.rms)	寿命 Load Life (Hours)
1	SVZ0JM471F8RE00RERF4	6.3	470	-20~+20	105	8*8.5	15	592	8	4000	2000

纹波电流频率系数Frequency coefficient for ripple current

频率Frequency	120Hz ≦ f < 1 kHz	1 KHz ≦ f < 10 kHz	10 KHz ≦ f < 100 kHz	100 KHz ≦ f < 300 kHz
系数Coefficient	0.05	0.3	0.7	1

Issued-date:	Name	Approval Sheet			
2020-5-5	File No	VZ	Version	01	Page 9
STANDARD MANUAL					

Starts	File Description	Component No./rev
Released	Approval Sheet- VZ	CRS-2020-VZ/01

11. 捺印 Marking

除非另有说明，捺印应该清晰地印在电容上

Unless otherwise specified. Capacitor shall be clearly marked on it body.

负极
Negative Polarity

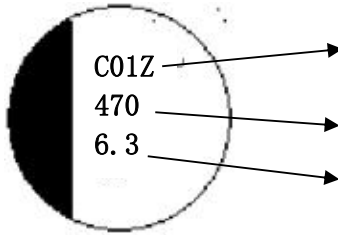

C:	年编码 Year code	2020年
01:	周编码 Week code	
Z:	系列 Series	VZ系列
额定电容 Rated Capacitance		470UF
额定电压 Rated voltage		6.3WV
印字油墨为红色 The colour of marking ink is red.		

年份代码

年份	2020	2021	2022	2023	2024	2025	2026	2027
代码	C	D	E	F	H	J	K	N
年份	2028	2029	2030	2031	2032	2033	2034	2035
代码	P	Q	S	T	U	V	X	Y

12. 匣盒带 Box cassette (单位 Unit:mm)

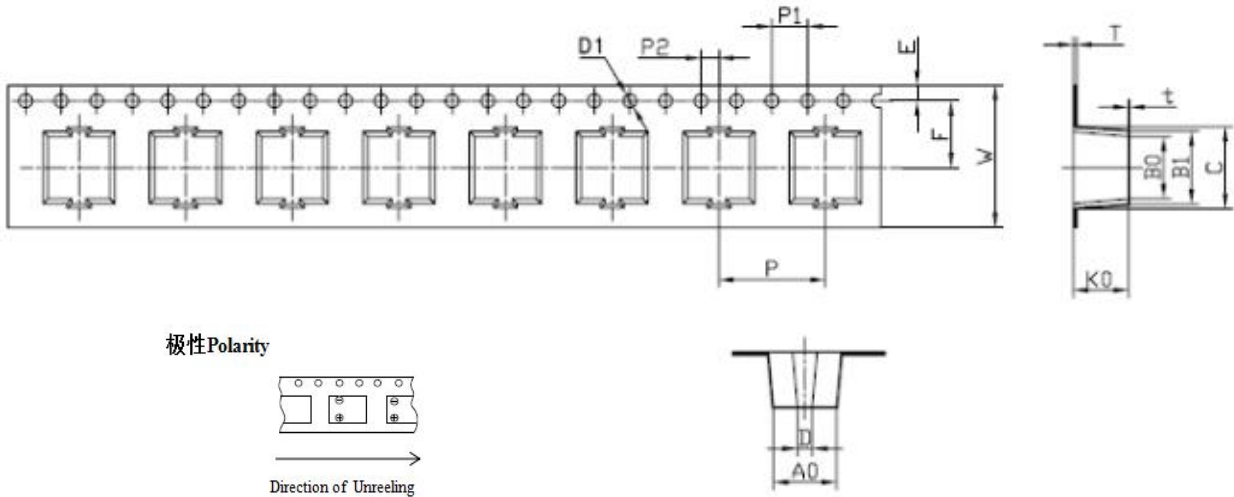

尺寸编码 Size Code	D1	K0	P	P1	P2	T	W	E	F	A0	B0	B1	D
	+0.1/-0	±0.1	±0.1	±0.1	±0.05	±0.1	±0.3	±0.1	±0.05	±0.2	±0.2	±0.1	±0.1
F8R	1.50	9.00	16.00	4.00	2.00	0.50	24.00	1.75	11.50	8.70	8.70	9.90	2.00

Issued-date:	Name	Approval Sheet					
2020-5-5	File No	VZ	Version	01	Page	10	
STANDARD MANUAL							

Starts	File Description	Component No./rev
Released	Approval Sheet- VZ	CRS-2020-VZ/01

13. 包装 Packing

Bulk: Standard

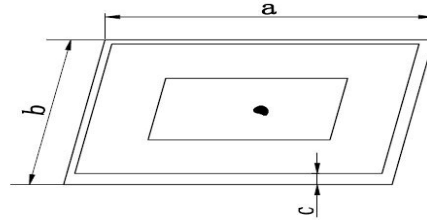
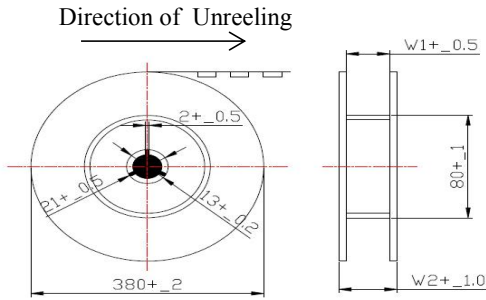

Paper carrier reel or plastic carrier reel

Zipper bag

Aishi	
P/N:	
CUSTOMER P/N	
SIZE:	
QTY	
DATE	

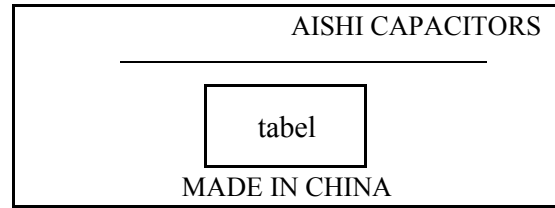

13.1 编带包装 Tape Packing

编带 Taping: 标准 Standard

分类 Classification	标准 Standard				
产品尺寸 Product size D*L(mm)	承载卷轴 Carrier reel/ (pcs)	外包箱 Outer carton/ (paper carrier reel) 390*225*390 (mm)	外包箱 Outer carton/ (plastic carrier reel) 390*225*390 (mm)	承载卷轴尺寸 Carrier reel size/ (mm)	
				W1±1	W2±1.0
6.3*4.5	1200	8	10	18	22
6.3*6	1000	8	10	18	22
6.3*9	800	8	10	18	22

产品尺寸 Product size D*L(mm)	承载卷轴 Carrier reel/ (pcs)	外包箱 Outer carton/ (paper carrier reel) 390*225*390 (mm)	承载卷轴尺寸 Carrier reel size/ (mm)	
			W1±1	W2±1.0
8*8.5	600	6	26	32
8*11.5	500	6	26	32
10*12.5	500	6	26	32

Issued-date:	Name	Approval Sheet				
2020-5-5	File No	VZ	Version	01	Page	11
STANDARD MANUAL						

Starts	File Description	Component No./rev
Released	Approval Sheet- VZ	CRS-2020-VZ/01

14. 操作注意事项 Operating Precautions

14.1 极性 Polarity

AishiCAP是具有正负极的固态铝电解电容，使用中不可反接，若接反，则电容会因为漏电流不断增大或短路而造成寿命缩短。

AishiCAP is a solid aluminum electrolytic capacitor with positive and negative electrodes. Do not reverse the polarity when using. If it is used with the polarities reversed, its life may shorten because of increasing leakage current or short circuit.

14.2 禁止电路 Prohibited circuits

因为焊接及其它动作可造成电容的漏电流增加，AishiCAP不可使用在下列电路中：

Since problems can be expected due to leakage current increasing during soldering and other processes, AishiCAP cannot be used in the following circuits

- 1) 高阻抗电路 1) High impedance circuits;
- 2) 耦合电路 2) Coupling circuits;
- 3) 时限恒量电路 3) Time constant circuits;
- 4) 为提高耐电压而串联两个或多个电容于电路中
4) Connection of two or more capacitors in series for higher withstand voltage;
- 5) 电路因漏电流过大而有坏的影响 5) Circuits to get bad influence by big leakage current

* 除漏电流的波动上升外，电容的使用条件如在承认书中规定的高温 and 低温，温热和耐受性条件都会影响电容量。若电容作为时限恒量电容使用，因其对电容量的变动的敏感性，电容量的改变会造成影响。不要将其作为时限恒量电容使用，同时若因电压原因要串联多个AishiCAP电容，请联系湖南艾华集团股份有限公司。

* In addition to the leakage current fluctuation above, the operational conditions such as characteristics at high and low temperature, damp heat and endurance stipulated in the specifications will affect the capacitance. The fluctuation of the capacitance may cause problem if it is used as a time constant capacitor, which is extremely sensitive to the fluctuation of the capacitance. Do not use it as a time constant capacitor. Additionally, please contact Hunan Aihua Group Co., Ltd. for usage of two or more AishiCAP in series for voltage proof.

14.3 过电压 Over voltage

电压若超过额定电压，即便只是一瞬间也可能造成短路

Over voltage exceeding the rated voltage may not be applied even for an instant as if may cause a short circuit.

14.4 突然充放电 Sudden charge and discharge

突然的充放电是不可取的（为了维持高的可靠性）。为防止突然的充放电造成电容短路或漏电过大，电路中应加上一个保护电路用以分流过大的电流。若瞬间电流超过10A或超过10倍允许纹波电流，要使用保护电路。在测试漏电流时请加上一个1kΩ的电阻用以充放电。

Sudden charge and discharge restricted (for maintenance of high-proof reliability). A protection circuit is recommended for when a sudden charge or discharge causes excessive rush current because this is a main cause of short circuits and large leakage current. Use protection circuits if the rush current exceeds 10A. The rush current exceeds 10×the maximum allowable ripple current of AishiCAP. Be sure to insert a protection resistor of about 1kΩ for charge and discharge when measuring the leakage current.

14.5 焊接注意事项 Considerations when soldering

焊接条件要在承认书的规定范围内。若没有遵守承认书的条件，则电容漏电流可能急剧增加，容量衰减。

The soldering conditions are to be within the range prescribed in specifications. If the specifications are not followed, there is a possibility of the cosmetic deflection, the intensive increase of leakage current, and the capacitance reduction.

使用需知 Things to be noted before mounting.

(a) 已安装过的或加过电压的AishiCAP请勿再使用。经历了周期性电性能测试的AishiCAP不可再用。

(a) Do not reuse AishiCAP that have been assembled in a set and energized. Excluding AishiCAP that have been removed for measuring electrical characteristics during a periodic inspection, AishiCAP cannot be reused.

Issued-date:	Name	Approval Sheet				
2020-5-5	File No	VZ	Version	01	Page	12
STANDARD MANUAL						

Starts	File Description	Component No./rev
Released	Approval Sheet- VZ	CRS-2020-VZ/01

(b) AishiCAP贮藏一年时间后，漏电流可能会增大，使用前，请在105℃，额定电压及接有1 kΩ电阻的条件下充电2小时。

(b) Leakage current may increase when AishiCAP are stored for one year. In this case, apply rated voltage for 2 hour at 105℃ with load of 1 kΩ resistor.

(c)回流焊接Reflow soldering

用于SMD系列Use flow soldering for SMD type

回流焊接Reflow soldering

焊接条件应该在下列范围内。

Soldering condition should be under the following ranges.

建议回流焊接条件

Recommended reflow soldering condition

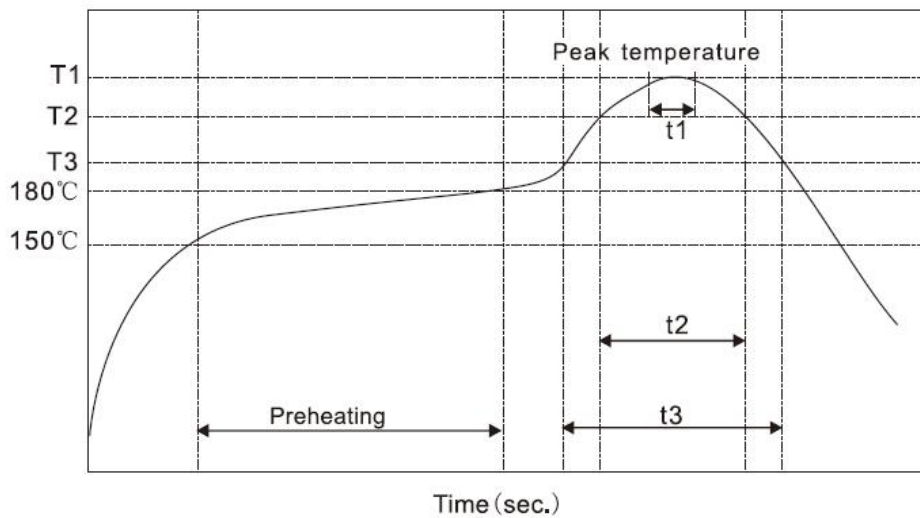

Item	Preheating	T1(°C)	T2(°C)	T3(°C)	t1(sec.)	t2(sec.)	t3(sec.)	Reflow cycle
Condition 1	150°C to 180°C	≤260	230	200	≤10	≤40	≤60	1
Condition 2	within 90sec.	≤250	230	200	≤10	≤40	≤60	2

(d)焊接后处理 Handling after soldering

在这之后，不要倾斜，弯曲或扭曲 Do not tilt, bend or twist the AishiCAP after it

不可通过抓捏AishiCAP来移动印刷电路板Do not move the PCB with catching AishiCAP itself.

堆叠印刷电路板时确保AishiCAP没有碰触到其它电路板或部件

When stacking PCBs, make sure that the AishiCAP does not touch other PCBs or components.

不可将AishiCAP与其它物品堆放Do not dump the AishiCAP with objects.

14.6 AishiCAP用于工业设备 Use of AishiCAP for industrial equipments

为确保AishiCAP在工业设备上的可靠性，设计必须与之相符。

To ensure reliability when the AishiCAP is used in industrial equipments, design must allow for its

14.7 AishiCAP用于生命保障系统 Use of AishiCAP for human life equipments

若使用于与人类生命有关的设备上（如空间设备、航空设备、原子设备等），请与湖南艾华集团股份有限公司详细咨询，不要使用没有湖南艾华集团股份有限公司承认文件的AishiCAP。

In case of using in equipments regarding human life(e.g. Space equipment, aeronautic equipment and atomic equipment etc.), be sure to talk over the matter with Hunan Ai hua Group Co., Ltd or Aishi. Don't use without recognition document of Hunan Ai hua Group Co., Ltd or Aishi.

Issued-date:	Name	Approval Sheet					
2020-5-5	File No	VZ	Version	01	Page	13	
STANDARD MANUAL							

Starts	File Description	Component No./rev
Released	Approval Sheet- VZ	CRS-2020-VZ/01

14.8 贮存Storage

1) 请将AishiCAP贮存于温度在5to 35℃之间，相对湿度在75%以下的没有阳光直射的环境中，如果可能可贮存于包裹中。(如果在35到85℃，他应该少于三个月)

1) Store AishiCAP with the temperature range between 5to 35℃ (If between 35 to 85℃, it should be less than three months), and the relative humidity of 75% or less without direct sunshine and store AishiCAP in the package states if possible.

2) AishiCAP请在使用前再打开包装袋并且快速用完。

2) AishiCAP are recommended that you shall open the bag just before use and AishiCAP shall be used up.

3) 不要在有水、盐水、油及凝结状况的地方贮存AishiCAP

3) Never store AishiCAP in which it is directly exposed to water, brine, oil or in condensation status.

4) 禁止在含有毒气体的区域放置AishiCAP (如：硫化氢、亚硫酸、亚硝酸、氯气、氨水等)

4) Never store AishiCAP in any area filled with poisonous gases(including hydrogen sulfide, sulfurous acid, nitrous acid, chlorine and ammonia).

5) 禁止在有紫外线或放射性辐射的区域放置AishiCAP。

5) Never store AishiCAP in any area to which ultraviolet and/or radial rays are radiated.

6) 存储时间storage time

开封前：出货后一年内 Before unseal : within 1 year after delivery

开封后：打开后7天内 After seal : within 7 days from opening

存放时间超过3年的电解电容器应报废处理 If storage time more than three years, the products need to be discarded

14.9 清洗Cleaning

关于HCFC，可用高浓酒精，石油，匝烯，水和表面活性剂以及别的溶剂（单独或混合使用）浸泡，用超声波，煮沸，蒸发等方法按制作者的建议清洗。更多详情请联系。

Concerning about HCFC, higher alcohol system, petroleum system, terpene system, water system with surface active agent and other solvents the washing way (separateness or combinations) by soak, ultrasonic wave, boil, vapor etc. is confirmed under the maker's recommendation. Please contact us if you require further details.

14.10 AishiCAP设计电路的说明 Notes on circuit designs for AishiCAP

14.10.1 执行Performance

在承认书中指定的额定性能范围内使用AishiCAP。

Use AishiCAP within the rating and performance ranges defined in this specifications.

14.10.2 使用温度和纹波电流 Operating temperature and ripple current

如果AishiCAP的使用温度超过了上限温度（105℃）或是有过载纹波电流通过，则有较大可能使寿命缩短，或漏电流增大，造成AishiCAP失效。

If AishiCAP is used at a temperature higher than the upper category temperature(105℃), or excess ripple current flows through AishiCAP, there are high possibilities of life cycle reduction or leakage current increasing to cause AishiCAP defective.

14.10.3 漏电流Leakage current

漏电流会因焊接条件而有些微的上升，加载直流电压可使电容自我修复，漏电流逐渐减小。

The leakage current of AishiCAP may increase slightly by soldering conditions. The application of DC voltage enables the capacitors to be repaired by itself and this leads the leakage current to be smaller gradually.

14.10.4 使用电压Applied voltage

为了保证AishiCAP的可靠性，加载到AishiCAP上的电压最好小于其额定电压。直流加交流电压的峰值应小于额定电压。

For the reliability of AishiCAP, it is recommended that the voltage applied to AishiCAP should be less than the rated voltage. Peak value of the the dc and ac voltage should not exceed its rated voltage.

Issued-date:	Name	Approval Sheet				
2020-5-5	File No	VZ	Version	01	Page	14
STANDARD MANUAL						

Starts	File Description	Component No./rev
Released	Approval Sheet- VZ	CRS-2020-VZ/01

14.10.5失效模式Failure mode

AishiCAP含有导电聚合物，其寿命的终止大部分是由于偶然失效模式，主要是短路。如果短路，AishiCAP将会因持续电流流过而过热，然后铝壳会因内部压力的增加而脱离电容。

AishiCAP contains a conductive polymer. The life ends mostly due to random failure mode, mainly short circuit. In case of short circuit, AishiCAP can be overheated by continuous current flow, then case of AishiCAP would be removed by internal pressure increasing.

14.10.6变更提前通知Advance consultation for changing

如果承认书改变，我们会提前通知

It is conducted under an advance consultation with you if this specification is changed.

Issued-date:	Name	Approval Sheet				
2020-5-5	File No	VZ	Version	01	Page	15
STANDARD MANUAL						