

Features

- Halogen Free Available Upon Request By Adding Suffix "-HF"
- Lead Free Finish/RoHS Compliant(Note 1) ("P" Suffix Designates RoHS Compliant. See Ordering Information)
- Low Forward Voltage Drop And Low Switching Noise
- High Surge Current Capability And High Current Capability
- Epoxy Meets UL 94 V-0 Flammability Rating
- Moisture Sensitivity Level 1

Maximum Ratings

- Operating Junction Temperature Range: -55°C to +150°C
- Storage Temperature Range: -55°C to +150°C
- Maximum Thermal Resistance: 18°C/W Junction to Ambient

MCC Part Number	Device Marking	Maximum Recurrent Peak Reverse Voltage	Maximum RMS Voltage	Maximum DC Blocking Voltage
SR502	SR502	20V	14V	20V
SR503	SR503	30V	21V	30V
SR504	SR504	40V	28V	40V
SR505	SR505	50V	35V	50V
SR506	SR506	60V	42V	60V
SR508	SR508	80V	56V	80V
SR5010	SR5010	100V	70V	100V

Electrical Characteristics @ 25°C Unless Otherwise Specified

Average Forward Current	$I_{F(AV)}$	5.0A	$T_A=85^\circ\text{C}$
Peak Forward Surge Current	I_{FSM}	150A	8.3ms, Half Sine
Maximum Instantaneous Forward Voltage SR502-SR504 SR505-SR506 SR508-SR5010	V_F	0.55V 0.70V 0.85V	$I_{FM}=5.0A;$ $T_J=25^\circ\text{C}$
Maximum DC Reverse Current at Rated DC Blocking Voltage	I_R	0.1mA	$T_J=25^\circ\text{C};$
Typical Junction Capacitance	C_J	200pF	Measured at 1.0MHz, $V_R=4.0V$

Note :1. High Temperature Solder Exemption Applied, see EU Directive Annex 7a.

5 Amp Schottky Barrier Rectifier 50 to 100 Volts

DO-201AD

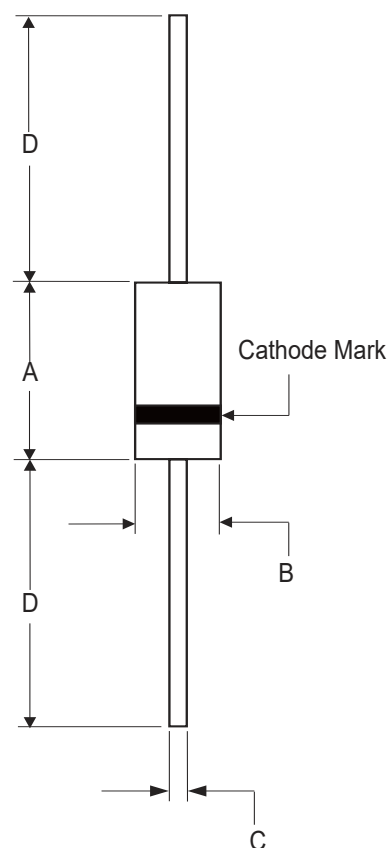

DIM	INCHES		MM		NOTE
	MIN	MAX	MIN	MAX	
A	0.287	0.374	7.30	9.50	
B	0.189	0.208	4.80	5.30	
C	0.048	0.052	1.20	1.30	
D	1.000	-----	25.40	-----	

Curve Characteristics

Fig. 1- Forward Current Derating Curve

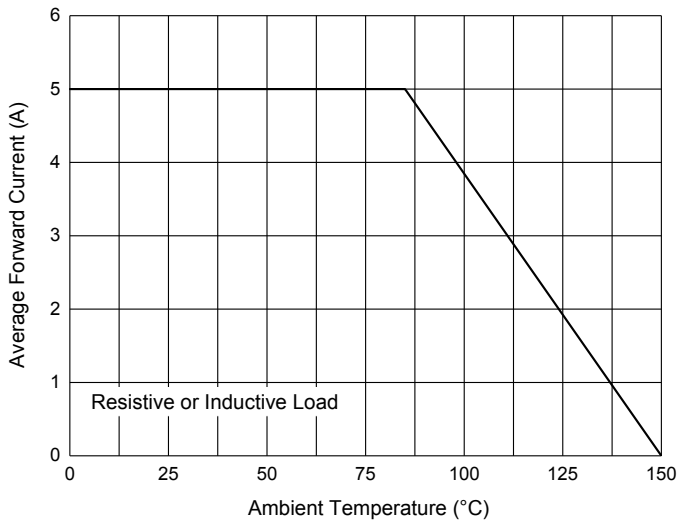

Fig. 2 - Maximum Non-Repetitive Peak Forward Surge Current

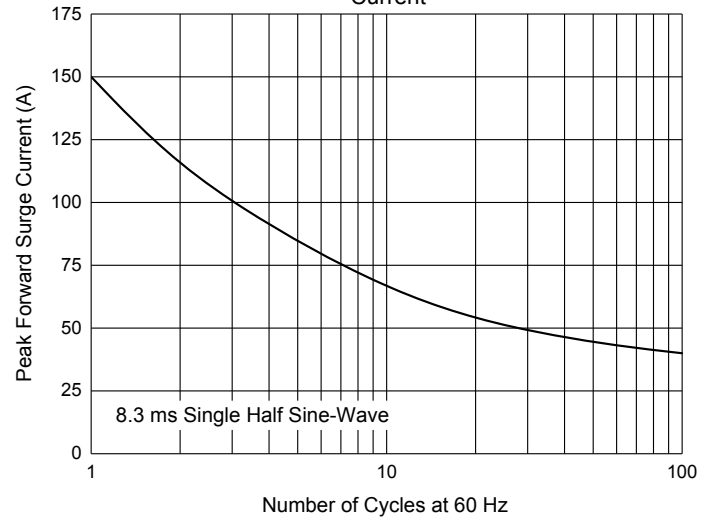

Fig. 3 - Typical Instantaneous Forward Characteristics

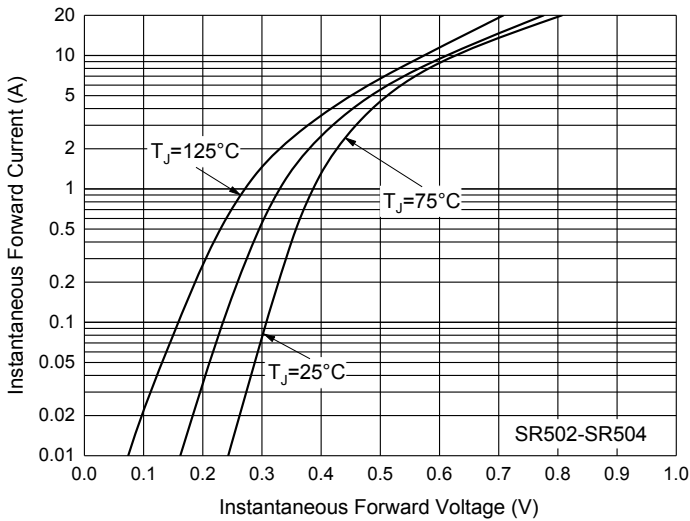

Fig. 4 - Typical Instantaneous Forward Characteristics

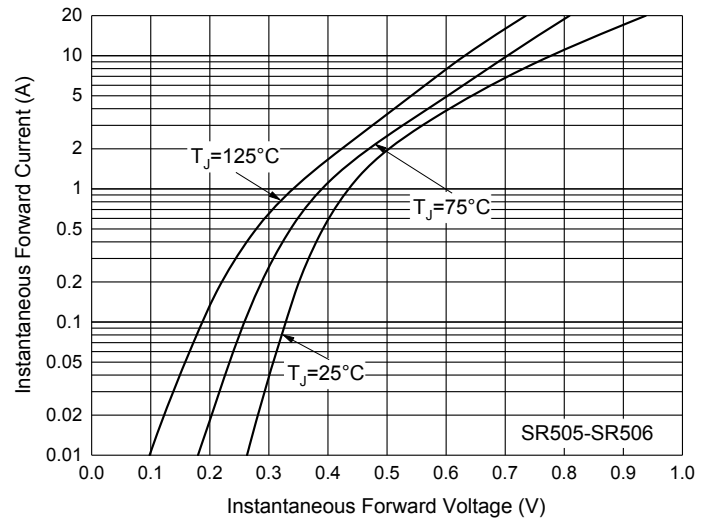

Fig. 5 - Typical Instantaneous Forward Characteristics

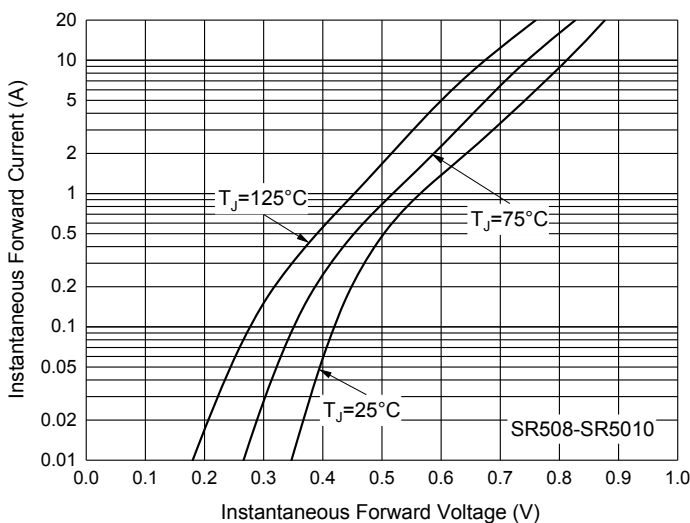
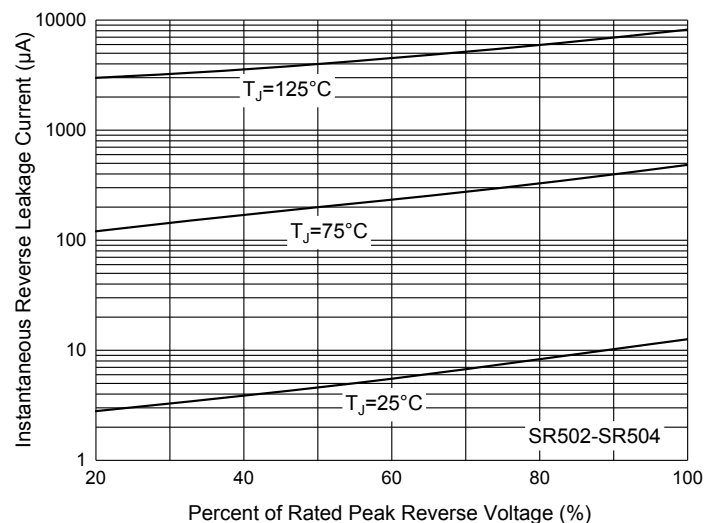

Fig. 6 - Typical Reverse Leakage Characteristics



Curve Characteristics

Fig. 7 - Typical Reverse Leakage Characteristics

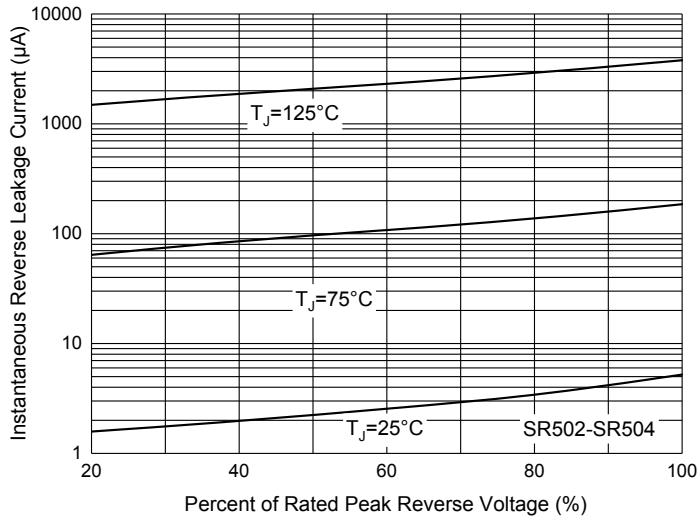
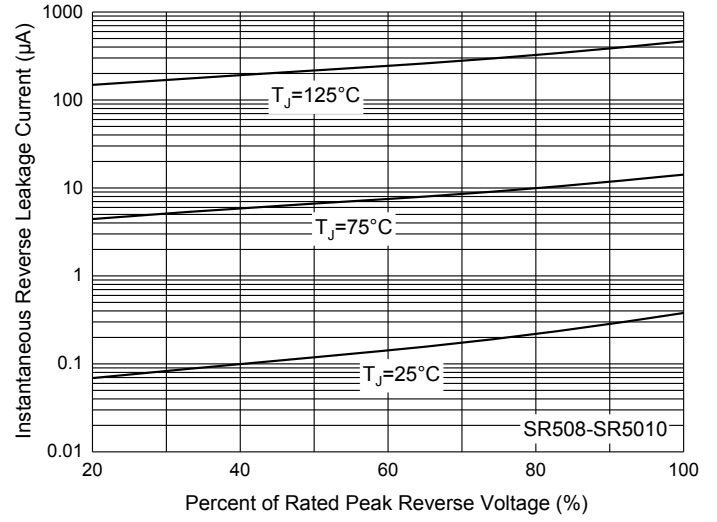

Fig. 8 - Typical Reverse Leakage Characteristics



Ordering Information

Device	Packing
Part Number-TP	Tape&Reel: 1.2Kpcs/Reel
Part Number-AP	Ammo Packing: 1.2Kpcs/Ammo Box
Part Number-BP	Bulk: 12Kpcs/Carton

Note : Adding "-HF" Suffix For Halogen Free, eg. Part Number-TP-HF

IMPORTANT NOTICE

Micro Commercial Components Corp. reserves the right to make changes without further notice to any product herein to make corrections, modifications, enhancements, improvements, or other changes. **Micro Commercial Components Corp.** does not assume any liability arising out of the application or use of any product described herein; neither does it convey any license under its patent rights, nor the rights of others. The user of products in such applications shall assume all risks of such use and will agree to hold **Micro Commercial Components Corp.** and all the companies whose products are represented on our website, harmless against all damages.

LIFE SUPPORT

MCC's products are not authorized for use as critical components in life support devices or systems without the express written approval of Micro Commercial Components Corporation.

CUSTOMER AWARENESS

Counterfeiting of semiconductor parts is a growing problem in the industry. Micro Commercial Components (MCC) is taking strong measures to protect ourselves and our customers from the proliferation of counterfeit parts. MCC strongly encourages customers to purchase MCC parts either directly from MCC or from Authorized MCC Distributors who are listed by country on our web page cited below. Products customers buy either from MCC directly or from Authorized MCC Distributors are genuine parts, have full traceability, meet MCC's quality standards for handling and storage. **MCC will not provide any warranty coverage or other assistance for parts bought from Unauthorized Sources.** MCC is committed to combat this global problem and encourage our customers to do their part in stopping this practice by buying direct or from authorized distributors.