

### 251/253 Series, PICO® II Very Fast-Acting Fuse



#### Description

The PICO® II Very Fast-Acting Fuse is designed to meet an extensive array of performance characteristics in a space-saving subminiature package.

#### Features





- Very fast-acting
- Small size
- Wide current rating range (0.062A- 15A)
- Halogen-free available
- Wide operating temperature range
- Low temperature re-rating

#### Applications

Secondary protection for space constrained applications

- Flat-panel display TV
- LCD monitor
- LCD backlight inverter
- Office machines
- Power supply
- Audio/Video system
- Lighting system
- Medical equipment

#### Agency Approvals

Agency	Agency File Number		Ampere Range
	253 Series	251 Series	
	E10480		0.062A - 15A
	29862		0.062A - 15A
	PSE_NBK200416-JP1021		1A - 5A
	J50158379		0.500A - 10A
<b>FM10</b>	N/A		0.062A - 15A
	2009010207366577		0.500A, 1A, 2A, 2.5A, 3A, 4A, 5A

Note: See Electrical Specifications by Item table for specific approved ratings.

#### Electrical Characteristics for Series

% of Ampere Rating	Ampere Rating	Opening Time
100%	0.062A - 15A	4 Hours, Min.
	0.062A - 7A	1 Second, Max.
	10A	3 Seconds, Max.
200%	12 - 15A	10 Seconds, Max.
	0.500A, 1A, 2A, 2.5A, 3A, 4A, 5A, 7A, 10A	300 msecs., Max.
275%	0.500A, 1A, 2A, 2.5A, 3A, 4A, 5A, 7A, 10A	300 msecs., Max.
400%	0.5A, 1A, 2A, 2.5A, 3A, 4A, 5A, 7A, 10A	30 msecs., Max.
1000%	0.500A, 1A, 2A, 2.5A, 3A, 4A, 5A, 7A, 10A	4 msecs., Max.

#### Additional Information



**Datasheet**  
251 Series



**Resources**  
251 Series



**Samples**  
251 Series



**Datasheet**  
253 Series



**Resources**  
253 Series









**Samples**  
253 Series

# Axial Lead & Cartridge Fuses

## PICO® II > Very Fast-Acting Fuse > 251/253 Series

### Electrical Specifications by Item

Ampere Rating (A)	Amp Code	Ordering Number (Std.)	Ordering Number (Mil.)	Max Voltage Rating (V)	Interrupting Rating	Nominal Cold Resistance (Ohms)	Nominal Melting I <sup>2</sup> t (A <sup>2</sup> sec)	Nom Voltage Drop (V)	Agency Approvals					
														
.062	.062	251.062	253.062	125	300 A @ 125VDC 50A@125VAC	7.000	0.000113	1.4	x	x			x	
.125	.125	251.125	253.125	125		1.700	0.00174	0.285	x	x			x	
.200	.200	251.200	253.200	125		0.895	0.0048	0.345	x	x				
.250	.250	251.250	253.250	125		0.665	0.0116	0.24	x	x			x	
.375	.375	251.375	253.375	125		0.395	0.0296	0.215	x	x			x	
.500	.500	251.500	253.500	125		0.302	0.0598	0.2165	x	x		x	x	x
.630	.630	251.630		125		0.205	0.08	0.188	x	x				
.750	.750	251.750	253.750	125		0.175	0.153	0.176	x	x		x	x	
1.00	001.	251001.	253001.	125		0.128	0.256	0.194	x	x	x	x	x	x
1.25	1.25	2511.25		125		0.100	0.390	0.2	x	x	x			
1.50	01.5	25101.5	25301.5	125		0.0823	0.587	0.21	x	x	x	x	x	
2.00	002.	251002.	253002.	125		0.0473	0.405	0.141	x	x	x	x	x	x
2.50	02.5	25102.5		125		0.0360	0.721	0.132	x	x	x	x		x
3.00	003.	251003.	253003.	125		0.0295	1.19	0.131	x	x	x	x	x	x
3.50	03.5	25103.5		125		0.0240	1.58	0.1205	x	x	x	x		
4.00	004.	251004.	253004.	125		0.0204	2.45	0.114	x	x	x	x	x	x
5.00	005.	251005.	253005.	125		0.0158	4.14	0.11	x	x	x	x	x	x
7.00	007.	251007.	253007.	125		0.0107	10.4	0.102	x	x		x	x	
10.0	010.	251010.	253010.	125		0.0072	25.5	0.1	x	x		x	x	
12.0	012.	251012.		32		300A@32VDC).0059	45.2	0.0878	x	x				
15.0	015.	251015.	253015.	32	& 50A@32VAC .00446	68.8	0.071	x	x			x		

Note: Higher ampere ratings are available. Please contact Littelfuse Technical Support or your Littelfuse products representative for assistance.

**Temperature Re-rating Curve**

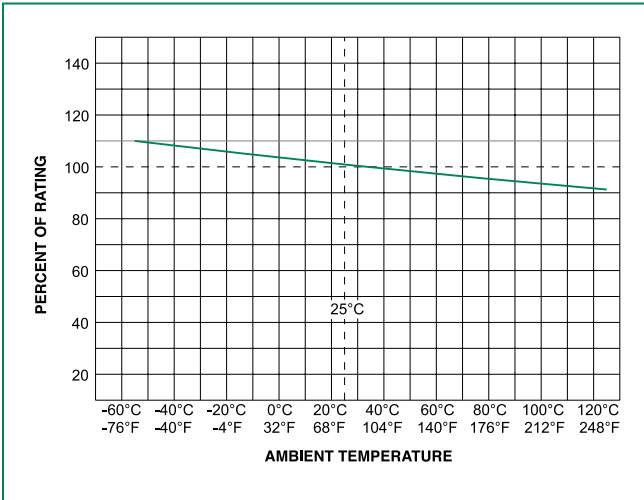

Note:  
 1. Re-rating depicted in this curve is in addition to the standard derating of 25% for continuous operation.

**Average Time Current Curves**

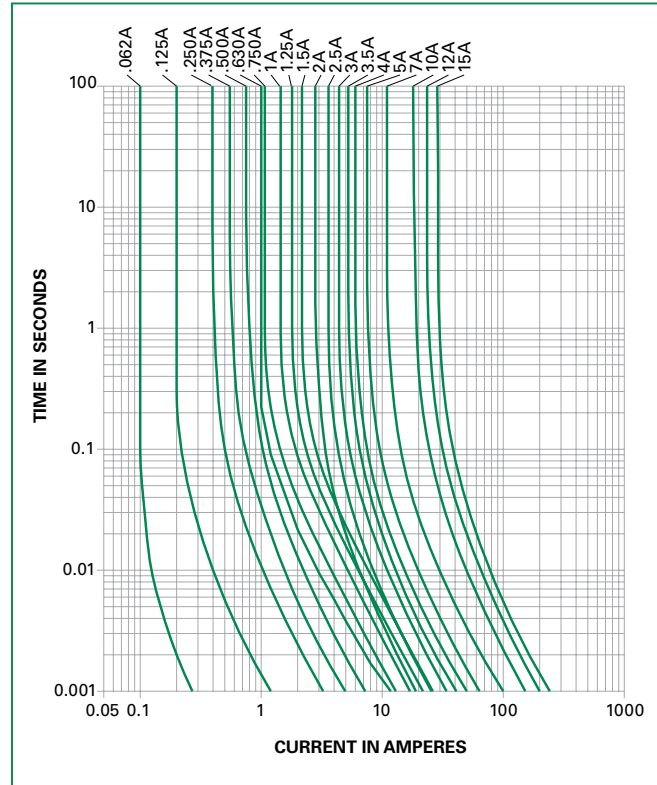

**Soldering Parameters**

**Recommended Process Parameters:**

Wave Parameter	Lead-Free Recommendation for 251 Series only
<b>Preheat:</b> (Depends on Flux Activation Temperature)	(Typical Industry Recommendation)
Temperature Minimum:	100°C
Temperature Maximum:	150°C
Preheat Time:	60-180 seconds
<b>Solder Pot Temperature:</b>	260°C Maximum
<b>Solder Dwell Time:</b>	2-5 seconds

**Recommended Hand Soldering Parameters:**

Solder Iron Temperature: 350°C +/- 5°C  
 Heating Time: 5 seconds max.

**Note: These devices are not recommended for IR or Convection Reflow process**

### Product Characteristics

<b>Materials</b>	Encapsulated, Epoxy-coated Body 251 Series: Pure tin-coated copper wire leads 253 Series: Solder-coated copper wire leads
<b>Solderability</b>	MIL-STD-202, Method 208
<b>Lead Pull Force</b>	MIL-STD-202, Method 211, Test Condition A (will withstand a 7lbs. axial pull test)
<b>Fuses To MIL SPEC</b>	For fuses to MIL-PRF-23419, FM10 change the series number from 251 to 253
<b>Operating Temperature</b>	-55°C to +125°C (Consider re-rating)

<b>Vibration</b>	MIL-STD-202, Method 201 (10–55 Hz); Method 204, Test Condition C (55–2000 Hz at 10 G's Peak)
<b>Shock</b>	MIL-STD-202, Method 213, Test Condition I (100 G's peak for 6 msecs.)
<b>Insulation Resistance (After Opening):</b>	MIL-STD-202, Method 302, Test Condition A (10,000 ohms minimum at 100 volts)
<b>Moisture Resistance</b>	MIL-STD-202, Method 106
<b>Resistance to Soldering Heat</b>	Withstands 60 seconds above 200°C and up to 260°C, maximum
<b>Flammability Rating</b>	UL 94V-0

### Dimensions

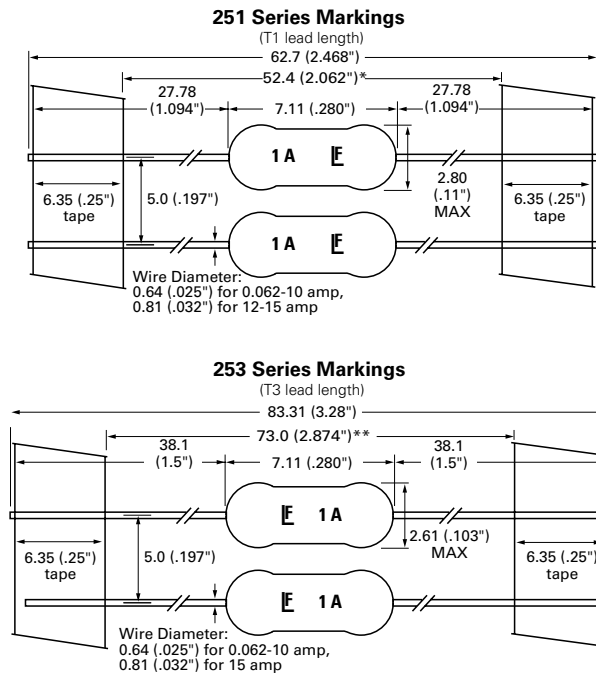

### Part Numbering System

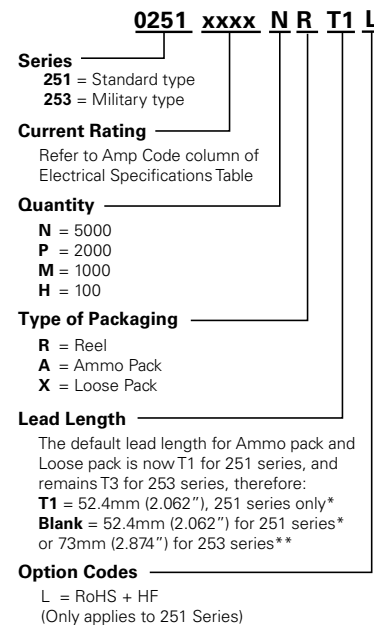

### Packaging

Packaging Option	Packaging Specification	Quantity & Packaging Code
*T1: 52.4mm (2.062") Tape and Reel	EIA 296	Please refer to available quantities above in "Part Numbering System"
**T3: 73mm (2.874") Tape and Reel	EIA 296	

The default lead length for both ammo pack and loose pack is T1 for 251 and is T3 for 253.

Notes: \* T1 dimension is defined as the length of the component between the two tapes. The full component length is 62.7mm (2.468"). **T1 length is for 251 series only.**  
 \*\* T3 dimension is defined as the length of the component between the two tapes. The full component length is 83.37mm (3.28"). **T3 length is for 253 series only.**

**Disclaimer Notice** - Information furnished is believed to be accurate and reliable. However, users should independently evaluate the suitability of and test each product selected for their own applications. Littelfuse products are not designed for, and may not be used in, all applications. Read complete Disclaimer Notice at: [www.littelfuse.com/disclaimer-electronics](http://www.littelfuse.com/disclaimer-electronics).