

WS72542
Low-Power Rail-to-Rail Input Output Operational Amplifiers
[Http://www.willsemi.com](http://www.willsemi.com)
Descriptions

The WS72542 series is a dual low-voltage operational amplifier with rail-to-rail input/output swing. Ultra low quiescent current makes this amplifier ideal for portable, battery operated equipment. The common mode input range includes ground making the device useful for low-side current-shunt measurements.

The WS72542 is available with MSL 3 Level in SOP-8L package and MSOP-8L package. Standard products are Pb-Free and halogen-Free.

Applications

- Active Filters
- Smoke/Gas Sensors
- Battery Powered Electronic Equipments
- Personal Medical Care

Features

- Single Supply Voltage : 1.8~5.5V
- Quiescent Current per Amplifier : 42µA Typical
- GBWP : 2MHz
- Slew Rate : 1.4V/µs
- Offset Voltage : 2mV Maximum
- Offset Voltage Temp. Drift : 1.1µV / °C
- THD+N : -102dB@1kHz,
-86dB@10kHz
- CMRR/PSRR : 110dB/106dB
- Output Short-Circuit Curr. : 46mA
- -40°C to 125°C Operation Range
- Drives 2kΩ Resistive Loads
- No Output Crossover Distortion
- No Phase Reversal from Overdriven Input
- Rail-to-Rail Input/Output Swing

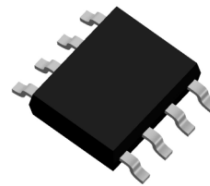
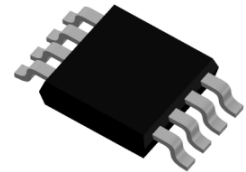
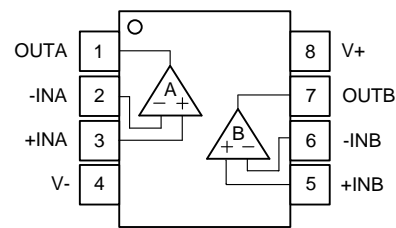
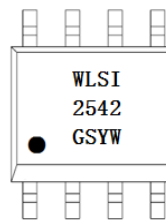
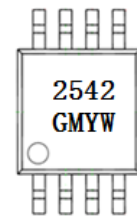
SOP-8L

MSOP-8L

SOP-8L/MSOP-8L
Pin configuration (Top view)

SOP-8L

MSOP-8L
Marking

- 2542** = Device code
- GS** = Special code
- GM** = Special code
- Y** = Year code
- W** = Week code

Order Information

Device	Package	Shipping
WS72542S-8/TR	SOP-8L	4000/Reel & Tape
WS72542M-8/TR	MSOP-8L	4000/Reel & Tape

Pin Descriptions

Pin Number	Symbol	Descriptions
1	OUTA	Output
2	-INA	Inverting input
3	+INA	Non-inverting input
4	V-	Negative supply
5	+INB	Non-inverting input
6	-INB	Inverting input
7	OUTB	Output
8	V+	Positive supply

Absolute Maximum Ratings

Parameter	Symbol	Value	Unit
Supply Voltage, ([V+] – [V-])	$V_S^{(2)}$	6	V
Input Differential Voltage	$V_{IDR}^{(3)}$	±6	V
Input Common Mode Voltage Range	V_{ICR}	(V ⁻)-0.2 to (V ⁺)+0.2	V
Output Short-Circuit Duration	t_{SO}	Unlimited	/
Operating Free-Air Temperature Range	T_A	-40 to 125	°C
Storage Temperature Range	T_{STG}	-65 to 150	°C
Junction Temperature Range	T_J	150	°C
Lead Temperature Range	T_L	260	°C

Note:

1. Stresses beyond those listed under Absolute Maximum Ratings may cause permanent damage to the device. These are only stress ratings, and functional operation of the device at these or any other conditions beyond those indicated under recommended operating conditions are not implied. Exposure to absolute-maximum-rated conditions for extended periods may affect device reliability.
2. All voltage values, except differential voltage are with respect to network terminal.
3. Differential voltages are at +IN with respect to -IN.

ESD, Electrostatic Discharge Protection

Symbol	Parameter	Condition	Minimum level	Unit
HBM	Human Body Model ESD	MIL-STD-883H Method 3015.8 JEDEC-EIA/JESD22-A114A	±8000	V
MM	Machine Model ESD	JEDEC-EIA/JESD22-A115	±350	V
CDM	Charged Device Model ESD	JEDEC-EIA/JESD22-C101E	±2000	V

Electronics Characteristics

The *denotes the specifications which apply over the full operating temperature range, otherwise specifications are at $T_A = 25^\circ\text{C}$. $V_S = 5\text{V}$, $V_{CM} = V_{OUT} = V_S/2$, $R_{load} = 100\text{k}\Omega$, $C_{load} = 100\text{pF}$.

Symbol	Parameter	Conditions	Min.	Typ.	Max.	Unit	
V_{OS}	Input Offset Voltage	$V_{CM} = V_S/2$	*	-2.0	± 0.1	2.0	mV
α_{VOS}	Input Offset Voltage Drift			1.1		$\mu\text{V}/^\circ\text{C}$	
I_{IB}	Input Bias Current			10		pA	
I_{OS}	Input Offset Current			10		pA	
V_n	Input Voltage Noise	$f=0.1\text{Hz to }10\text{Hz}$		5.2		μV_{P-P}	
		$f=10\text{Hz to }20\text{kHz}$		4.6		μV_{rms}	
e_n	Input Voltage Noise Density	$f=1\text{kHz}$		30		$\text{nV}/\sqrt{\text{Hz}}$	
		$f=10\text{kHz}$		23			
CMRR	Common Mode Rejection Ratio	$V_{CM}=0.1\text{V to }4.9\text{V}$	*	85	110		dB
V_{CM}	Common Mode Input Voltage Range		*	$(V^-)-0.2$		$(V^+)+0.2$	V
PSRR	Power Supply Rejection Ratio		*	90	106		dB
A_{VOL}	Open Loop Large Signal Gain	$V_{OUT}=0.1\text{V to }4.9\text{V}$, $R_{load}=10\text{k}\Omega$	*	100	109		dB
V_{OH}	High Level Output Voltage	$R_{load}=2\text{k}\Omega$			50		mV
		$R_{load}=10\text{k}\Omega$			5		
V_{OL}	Low Level Output Voltage	$R_{load}=2\text{k}\Omega$			50		mV
		$R_{load}=10\text{k}\Omega$			5		
I_{SC}	Output Short-Circuit Current	Sink/Source Current			46		mA
I_Q	Quiescent Current per Amplifier		*		42	60	μA
PM	Phase Margin	$R_{load}=100\text{k}\Omega$, $C_{load}=100\text{pF}$			65		degrees
GM	Gain Margin	$R_{load}=100\text{k}\Omega$, $C_{load}=100\text{pF}$			-15		dB
GBWP	Gain-Bandwidth Product	$f=1\text{kHz}$			2		MHz
t_s	Settling Time	1.5 to 3.5V, Unity Gain			0.1%	1.9	μs
		2.45 to 2.55V, Unity Gain			0.1%	0.29	
SR	Slew Rate	$A_V=1$, $V_{OUT}=1.5\text{V to }3.5\text{V}$, $R_{load}=100\text{k}\Omega$, $C_{load}=100\text{pF}$			1.4		$\text{V}/\mu\text{s}$
FPBW	Full Power Bandwidth	$2V_{P-P}$			240		kHz
THD+N	Total Harmonic Distortion and Noise	$f=1\text{kHz}$, $A_V=1$, $R_{load}=100\text{k}\Omega$, $V_{OUT}=2V_{PP}$			-102		dB
		$f=10\text{kHz}$, $A_V=1$, $R_{load}=100\text{k}\Omega$, $V_{OUT}=2V_{PP}$			-86		

Note:

1. Stresses beyond those listed under Absolute Maximum Ratings may cause permanent damage to the device. Exposure to any Absolute Maximum Rating condition for extended periods may affect device reliability and lifetime.
2. A heat sink may be required to keep the junction temperature below the absolute maximum rating when the output is shorted indefinitely.
3. Thermal resistance varies with the amount of PC board metal connected to the package. The specified values are for short traces connected to the leads.
4. Full power bandwidth is calculated from the slew rate $FPBW = SR/(\pi \cdot V_{P-P})$.

Typical Characteristics
 $T_A=25^\circ\text{C}$, $V_S=\pm 2.5\text{V}$, $V_{CM}=0\text{V}$, unless otherwise noted

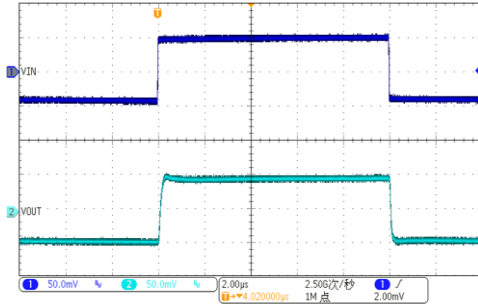
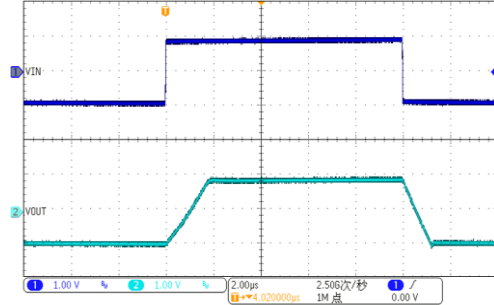
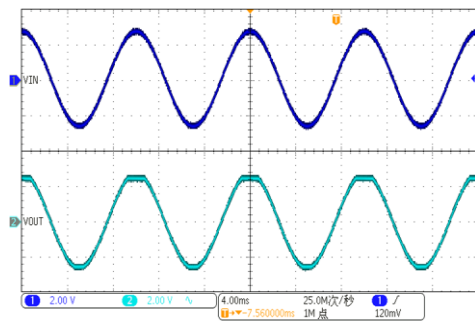
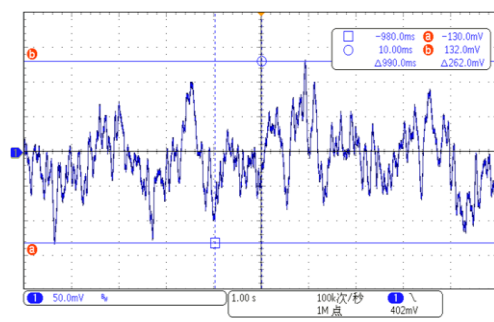
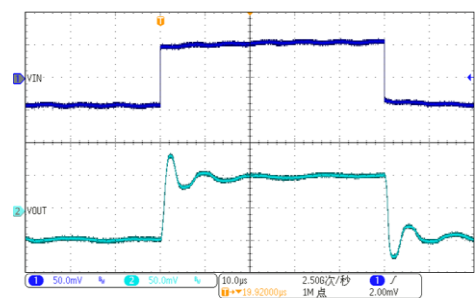
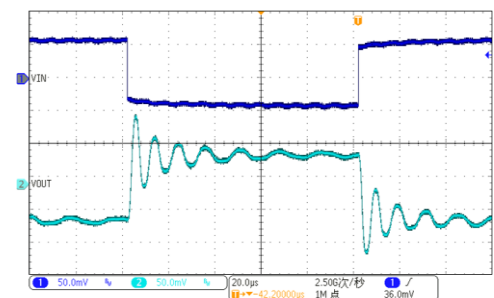
Small-Signal Step Response, 100mV Step

Large-Signal Step Response, 2V Step

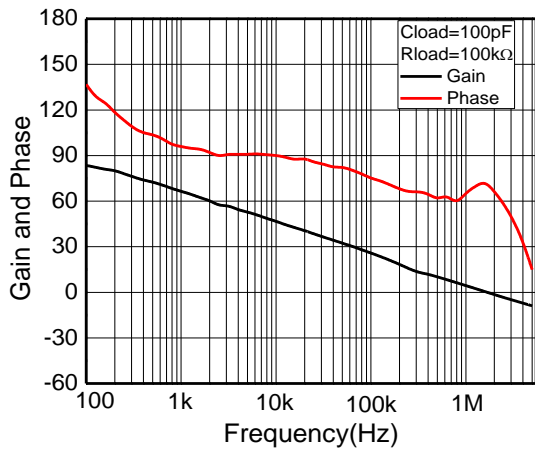
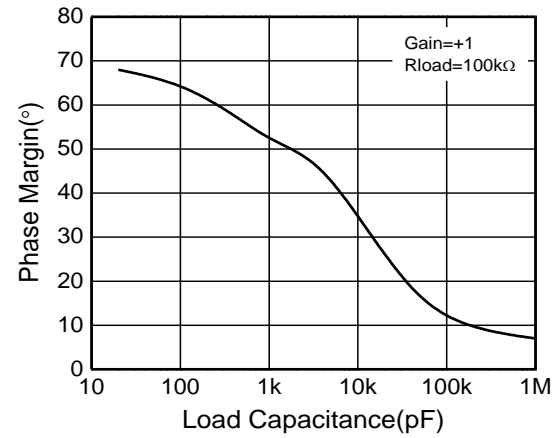
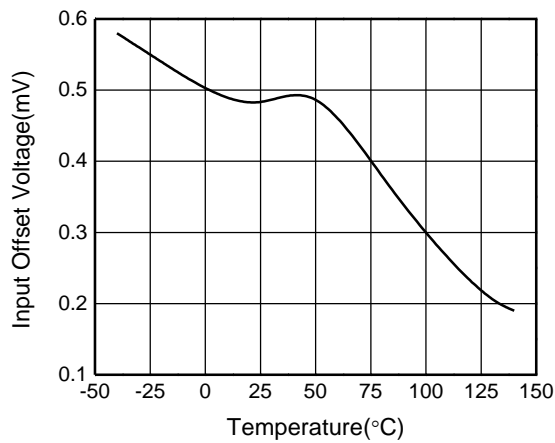
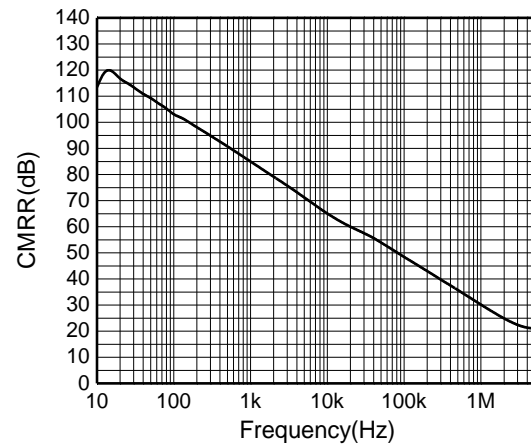
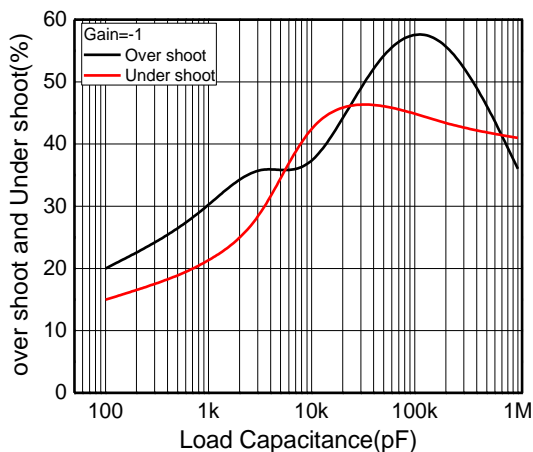
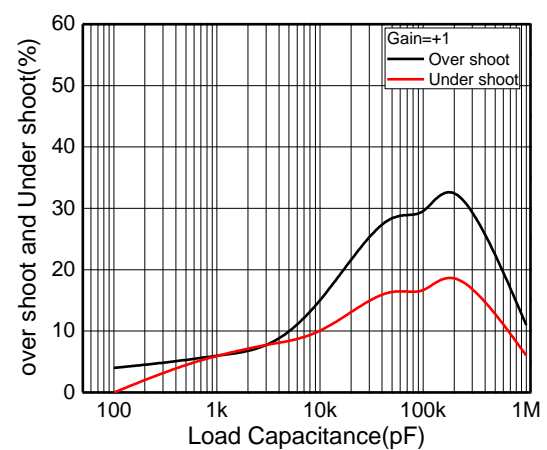
VIN=-0.2V to 5.7V, No Phase Reversal

0.1Hz to 10Hz Integrated Input Noise, Gain = 50000

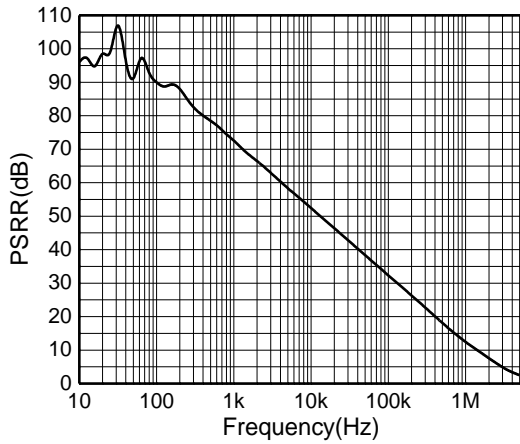
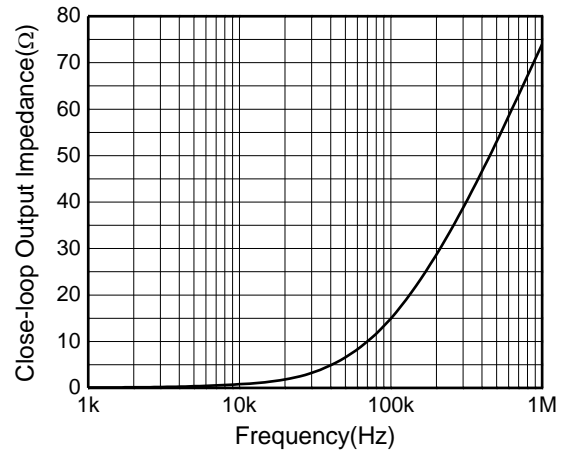
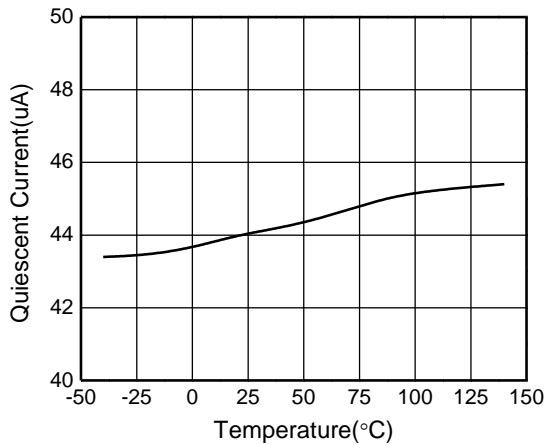
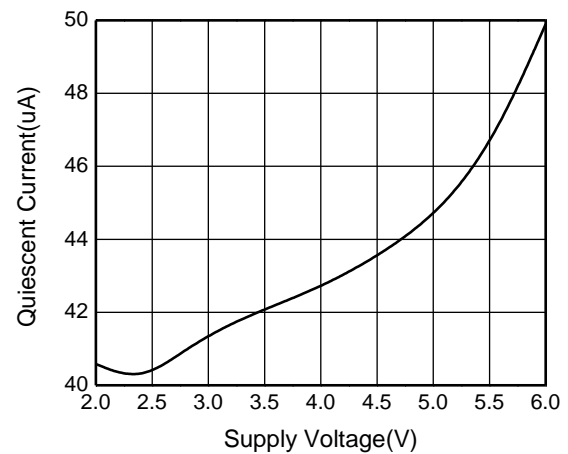
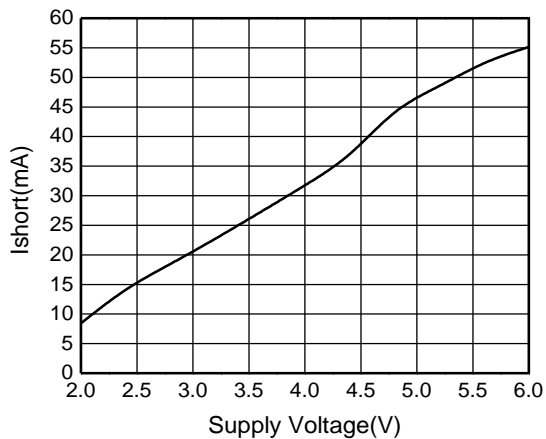
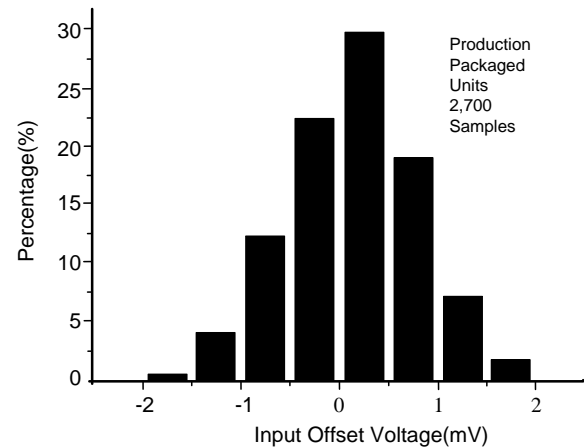
Over Shoot Voltage, $C_{load}=47\text{nF}$, $R_{FB}=10\text{k}\Omega$, Gain=+1

Over Shoot Voltage, $C_{load}=47\text{nF}$, $R_{load}=40\text{k}\Omega$, Gain=-1

Typical Characteristics (continued)
 $T_A=25^\circ\text{C}$, $V_S=\pm 2.5\text{V}$, $V_{CM}=0\text{V}$, unless otherwise noted

Open-Loop Gain and Phase

Phase Margin vs. C_{load} (Stable for Any C_{load})

Input Offset Voltage vs. Temperature

CMRR vs. Frequency

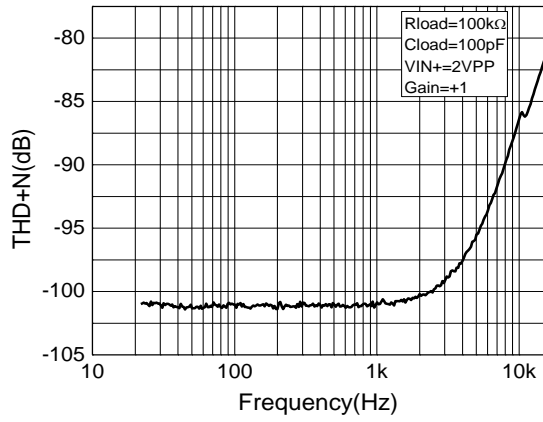
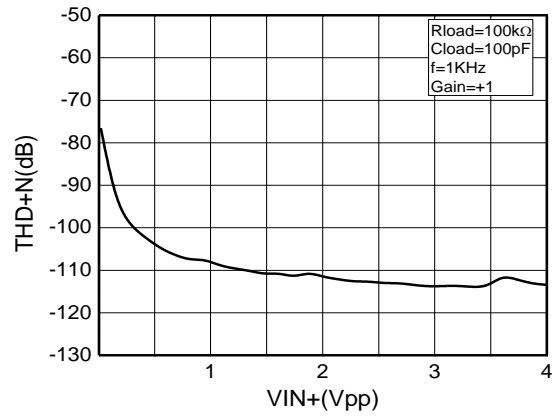
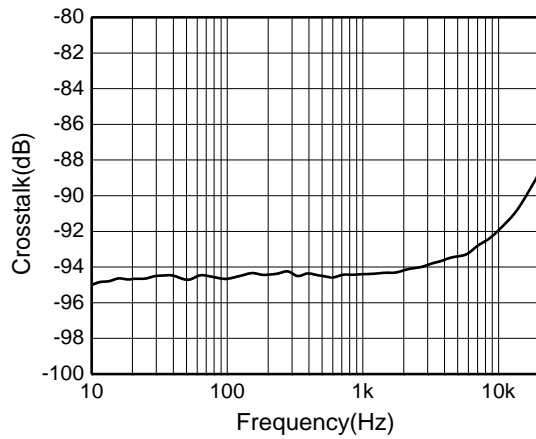
Over-Shoot % vs. C_{load}
Gain=-1, $R_{FB}=20\text{k}\Omega$

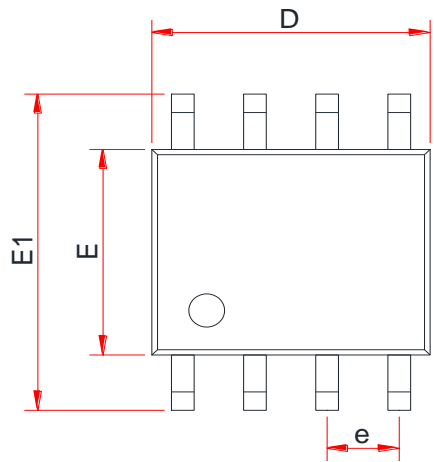
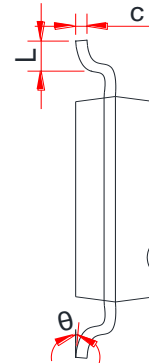
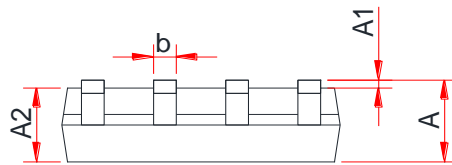
Over-Shoot % vs. C_{load}
Gain=+1

Typical Characteristics (continued)
 $T_A=25^\circ\text{C}$, $V_S=\pm 2.5\text{V}$, $V_{CM}=0\text{V}$, unless otherwise noted

PSRR vs. Frequency

Closed-Loop Output Impedance vs. Frequency

Quiescent Supply Current vs. Temperature

Quiescent Supply Current vs. Supply Voltage

Short-Circuit Current vs. Supply Voltage

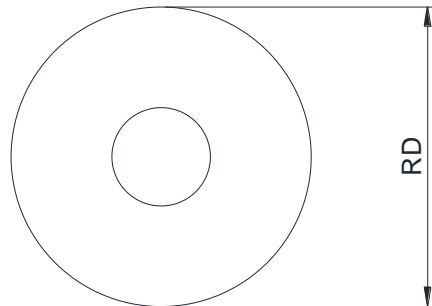
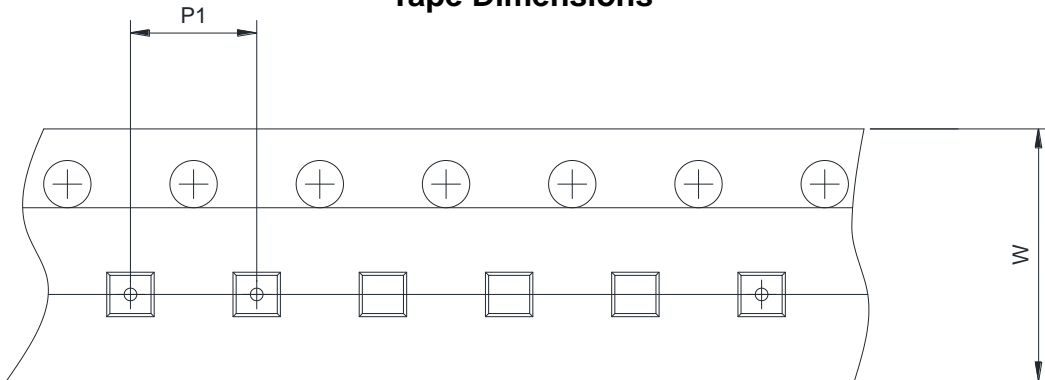
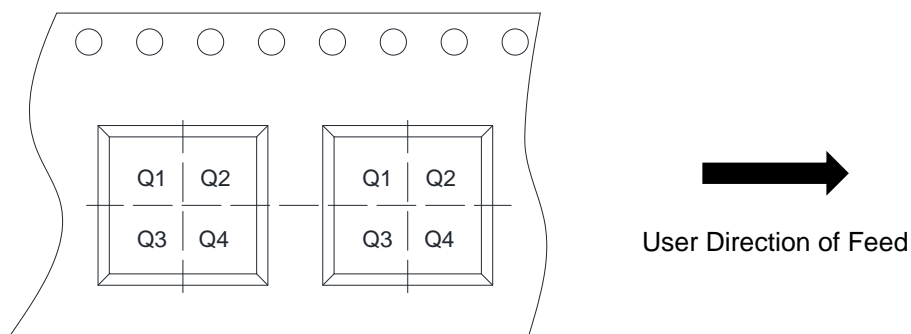
Input Offset Voltage Distribution

Typical Characteristics (continued)
 $T_A=25\text{ }^\circ\text{C}$, $V_S=\pm 2.5\text{V}$, $V_{CM}=0\text{V}$, unless otherwise noted

THD+Noise vs. Frequency

THD+Noise vs. VIN+

Crosstalk

PACKAGE OUTLINE DIMENSIONS
SOP-8L

TOP VIEW

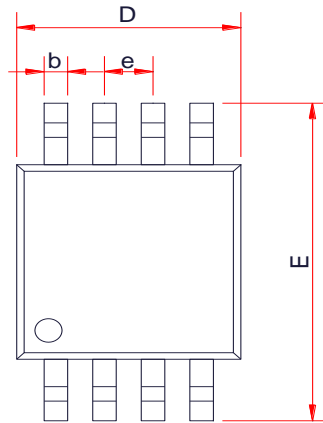
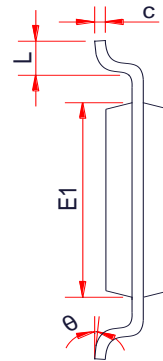
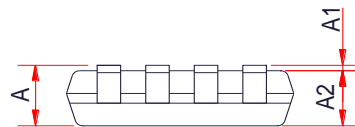
SIDE VIEW

SIDE VIEW

Symbol	Dimensions In Millimeters (mm)		
	Min.	Typ.	Max.
A	1.35	1.55	1.75
A1	0.05	0.15	0.25
A2	1.25	1.40	1.65
b	0.33	-	0.51
c	0.15	-	0.26
D	4.70	4.90	5.10
E	3.70	3.90	4.10
E1	5.80	6.00	6.20
e	1.27BSC		
L	0.40	-	1.27
θ	0°	-	8°

TAPE AND REEL INFORMATION
Reel Dimensions

Tape Dimensions

Quadrant Assignments For PIN1 Orientation In Tape

RD	Reel Dimension	<input type="checkbox"/> 7inch	<input checked="" type="checkbox"/> 13inch		
W	Overall width of the carrier tape	<input type="checkbox"/> 8mm	<input checked="" type="checkbox"/> 12mm		
P1	Pitch between successive cavity centers	<input type="checkbox"/> 2mm	<input type="checkbox"/> 4mm	<input checked="" type="checkbox"/> 8mm	
Pin1	Pin1 Quadrant	<input checked="" type="checkbox"/> Q1	<input type="checkbox"/> Q2	<input type="checkbox"/> Q3	<input type="checkbox"/> Q4

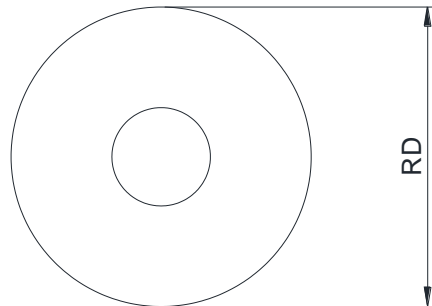
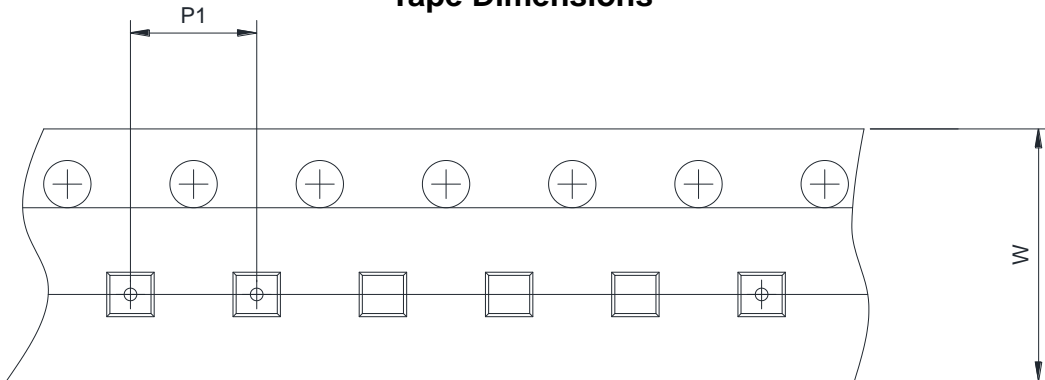
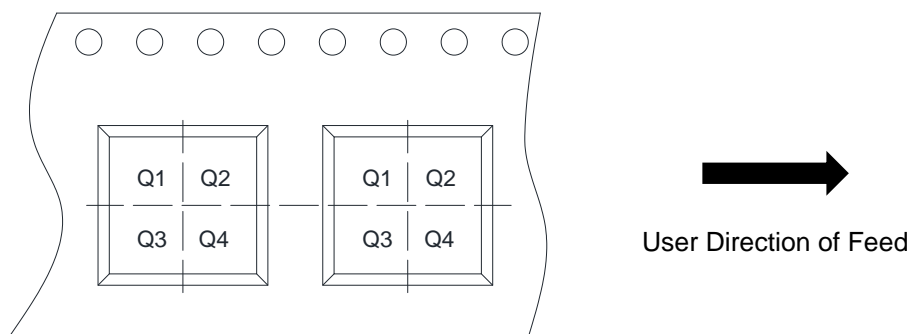
PACKAGE OUTLINE DIMENSIONS
MSOP-8L

TOP VIEW

SIDE VIEW

SIDE VIEW

Symbol	Dimensions In Millimeters (mm)		
	Min.	Typ.	Max.
A	-	-	1.10
A1	0.02	-	0.15
A2	0.75	0.80	0.95
b	0.25	-	0.38
c	0.09	-	0.23
D	2.90	3.00	3.10
E	4.75	4.90	5.05
E1	2.90	3.00	3.10
e	0.65 BSC		
L	0.40	-	0.80
θ	0°	-	6°

TAPE AND REEL INFORMATION
Reel Dimensions

Tape Dimensions

Quadrant Assignments For PIN1 Orientation In Tape

RD	Reel Dimension	<input type="checkbox"/> 7inch	<input checked="" type="checkbox"/> 13inch		
W	Overall width of the carrier tape	<input type="checkbox"/> 8mm	<input checked="" type="checkbox"/> 12mm		
P1	Pitch between successive cavity centers	<input type="checkbox"/> 2mm	<input type="checkbox"/> 4mm	<input checked="" type="checkbox"/> 8mm	
Pin1	Pin1 Quadrant	<input checked="" type="checkbox"/> Q1	<input type="checkbox"/> Q2	<input type="checkbox"/> Q3	<input type="checkbox"/> Q4