

**WS72041**
**600nA Nano-Power Rail-to-Rail Input Output Operational Amplifiers**
[Http://www.willsemi.com](http://www.willsemi.com)
**Descriptions**

The WS72041 is a single low-voltage operational amplifier with rail-to-rail input/output swing. Ultra low power makes this amplifier ideal for battery-powered and portable applications. The WS72041 has a gain-bandwidth product of 29kHz (TYP) and is unity gain stable. These specifications make this operational amplifier appropriate for low frequency applications, such as battery current monitoring and sensor conditioning.

WS72041 is available with MSL 3 Level in SOT-23-5L packages. Standard products are Pb-Free and halogen-Free.

**Applications**

- Handsets and Mobile Accessories
- Current Sensing
- Wireless Remote Sensors, Active RFID Readers
- Environment/Gas/Oxygen Sensors
- Threshold Detectors/Discriminators
- Low Power Filters
- Battery or Solar Powered Devices
- Sensor Network Powered by Energy Scavenging

**Features**

- Wide Supply Voltage : 1.6~5.5V
- Low Quiescent Current : 610nA Typical
- GBWP : 29kHz
- Rail-to-Rail Input/Output Swing
- Unity Gain Stable
- -40°C to 85°C Operation Temperature Range
- Available in Green SOT-23-5L Packages

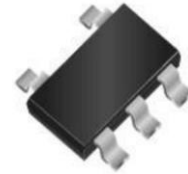
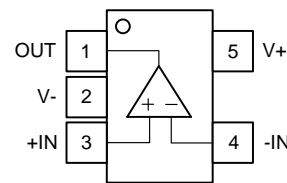
**SOT-23-5L**

**SOT-23-5L**
**Pin configuration (Top view)**

**SOT-23-5L**
**Marking**

- 2041** = Device code  
**GE** = Special code  
**Y** = Year code  
**W** = Week code

**Order Information**

Device	Package	Shipping
WS72041E-5/TR	SOT-23-5L	3000/Reel & Tape

**Pin Descriptions**

Pin Number	Symbol	Descriptions
1	OUT	Output
2	V-	Negative supply
3	+IN	Non-inverting input
4	-IN	Inverting input
5	V+	Positive supply

**Absolute Maximum Ratings<sup>(1)</sup>**

Parameter	Symbol	Value	Unit
Supply Voltage, ([V+] - [V-])	$V_S^{(2)}$	6	V
Input Common Mode Voltage Range	$V_{ICR}$	(V)-0.3 to (V <sup>+</sup> )+0.3	V
Output Short-Circuit Duration	$t_{SO}^{(3)}$	Unlimited	/
Operating Free-Air Temperature Range	$T_A$	-40 to 125	°C
Storage Temperature Range	$T_{STG}$	-65 to 150	°C
Junction Temperature Range	$T_J$	150	°C
Lead Temperature Range	$T_L$	260	°C

**Note:**

1. Stresses beyond those listed under Absolute Maximum Ratings may cause permanent damage to the device. These are only stress ratings, and functional operation of the device at these or any other conditions beyond those indicated under recommended operating conditions are not implied. Exposure to absolute-maximum-rated conditions for extended periods may affect device reliability.
2. All voltage values, except differential voltage are with respect to network terminal.
3. A heat sink may be required to keep the junction temperature below the absolute maximum. This depends on the power supply voltage and how many amplifiers are shorted. Thermal resistance varies the amount of PC board metal connected to the package. The specified values are for short traces connected to the leads.

**ESD, Electrostatic Discharge Protection**

Symbol	Parameter	Condition	Minimum level	Unit
HBM	Human Body Model ESD	MIL-STD-883H Method 3015.8 JEDEC-EIA/JESD22-A114A	±8000	V
CDM	Charged Device Model ESD	JEDEC-EIA/JESD22-C101E	±2000	V
MM	Machine Model ESD	JEDEC-EIA/JESD22-A115	±400	V

**Electronics Characteristics**

The \*denotes the specifications which apply over the full operating temperature range, otherwise specifications are at  $T_A = 27^\circ\text{C}$ .  $V_S = 5\text{V}$ ,  $V_{\text{CM}} = V_{\text{OUT}} = V_S/2$ ,  $R_{\text{load}} = 100\text{k}\Omega$ ,  $C_{\text{load}} = 60\text{pF}$ ,  $V_{\text{SHDN}}$  is unconnected.

Symbol	Parameter		Conditions	Min.	Typ.	Max.	Unit
$V_{\text{OS}}$	Input Offset Voltage		$V_{\text{CM}} = V_S/2$ and $V_{\text{CM}} = \text{GND}$ *	-3.0	$\pm 0.1$	3.0	mV
$\alpha_{\text{VOS}}$	Input Offset Voltage Drift				2.8		$\mu\text{V}/^\circ\text{C}$
$I_{\text{IB}}$	Input Bias Current				<10		pA
$I_{\text{OS}}$	Input Offset Current				<10		pA
$V_n$	Input Voltage Noise		$f=0.1\text{Hz}$ to $10\text{Hz}$		5		$\mu\text{V}_{\text{P-P}}$
$e_n$	Input Voltage Noise Density		$f=1\text{kHz}$		125		$\text{nV}/\sqrt{\text{Hz}}$
$R_{\text{IN}}$	Input Resistance				>1		T $\Omega$
CMRR	Common Mode Rejection Ratio		$V_{\text{CM}}=0.1\text{V}$ to $4.9\text{V}$ *	55	74		dB
$V_{\text{CM}}$	Common Mode Input Voltage Range			$(V^-)-0.3$ *		$(V^+)+0.3$	V
PSRR	Power Supply Rejection Ratio			60 *	86		dB
$A_{\text{VOL}}$	Open Loop Large Signal Gain		$V_{\text{OUT}}=2.5\text{V}$ , $R_{\text{load}}=100\text{k}\Omega$	80	120		dB
			$V_{\text{OUT}}=0.1\text{V}$ to $4.9\text{V}$ , $R_{\text{load}}=100\text{k}\Omega$ *	80	120		dB
$V_{\text{OL}}, V_{\text{OH}}$	Output Swing from Supply Rail		$R_{\text{load}}=100\text{k}\Omega$		3		mV
$R_{\text{OUT}}$	Closed-Loop Output Impedance		$G=1, f=1\text{kHz}, I_{\text{OUT}}=0$		0.7		$\Omega$
$I_{\text{SC}}$	Output Short-Circuit Current		Sink or Source Current	12	20		mA
$V_{\text{DD}}$	Supply Voltage			1.6		5.5	V
$I_{\text{Q}}$	Quiescent Current				610	760	nA
PM	Phase Margin		$R_{\text{load}}=100\text{k}\Omega$ , $C_{\text{load}}=60\text{pF}$		80		degrees
GM	Gain Margin		$R_{\text{load}}=100\text{k}\Omega$ , $C_{\text{load}}=60\text{pF}$		18		dB
GBWP	Gain-Bandwidth Product		$f=1\text{kHz}$		29		kHz
$t_s$	Settling Time	1.5 to 3.5V, Unity Gain	0.1%		0.18		ms
		2.45 to 2.55V, Unity Gain	0.1%		0.02		
SR	Slew Rate		$A_V=1$ , $V_{\text{OUT}}=1.5\text{V}$ to $3.5\text{V}$ , $R_{\text{load}}=100\text{k}\Omega$ , $C_{\text{load}}=60\text{pF}$		9		$\text{mV}/\mu\text{s}$
FPBW	Full Power Bandwidth <sup>Note1</sup>		$2V_{\text{P-P}}$		600		Hz

**Note:**

1. Full power bandwidth is calculated from the slew rate  $\text{FPBW} = \text{SR}/(\pi \cdot V_{\text{P-P}})$ .

**Typical Characteristics**
 $T_A=25^\circ\text{C}$ ,  $V_S=5\text{V}$ ,  $V_{\text{CM}}=V_S/2$ , unless otherwise noted

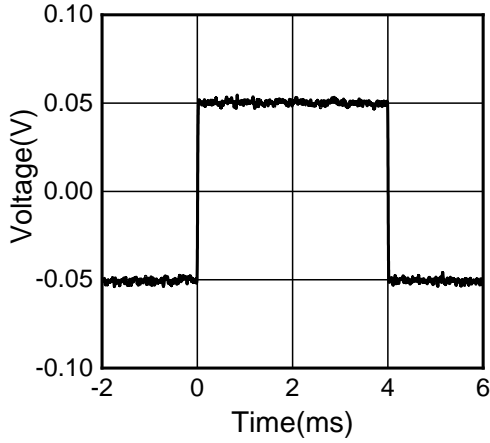
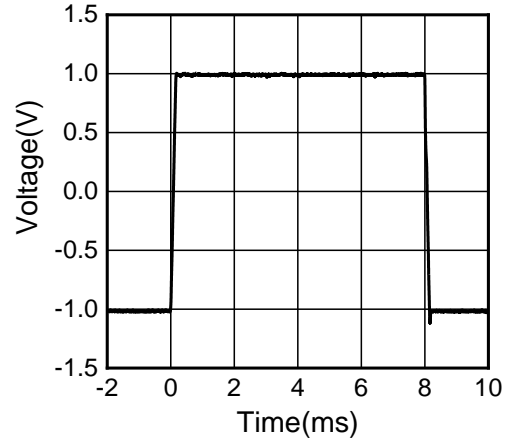
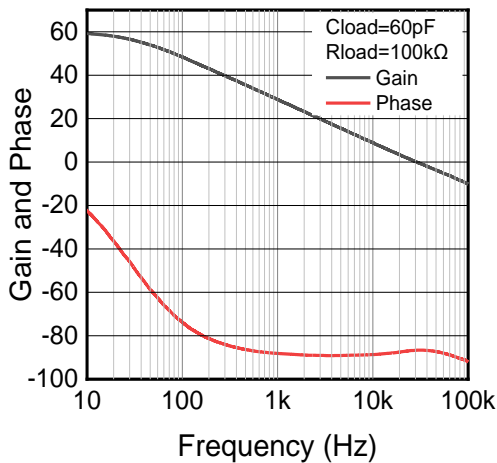
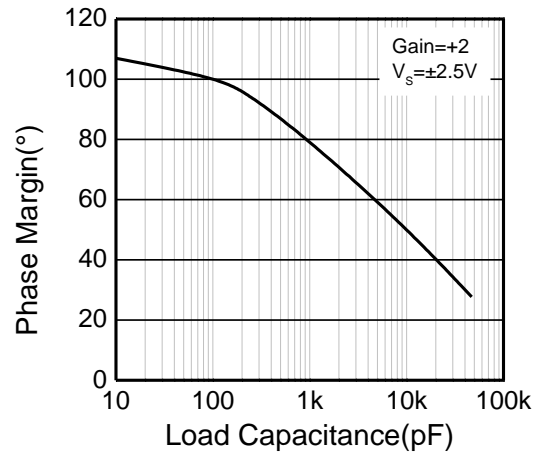
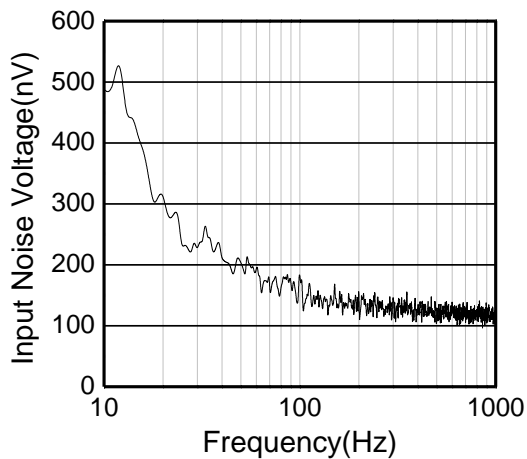
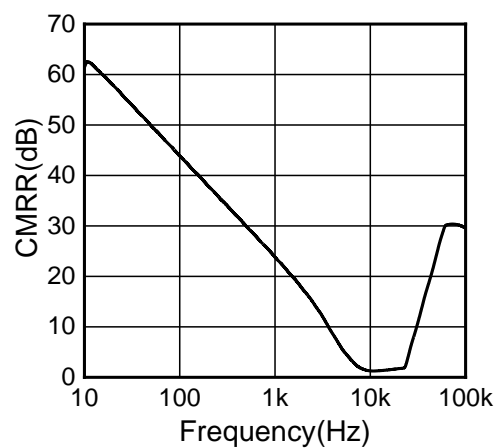
**Small-Signal Step Response, 100mV Step**

**Large-Signal Step Response, 2V Step**

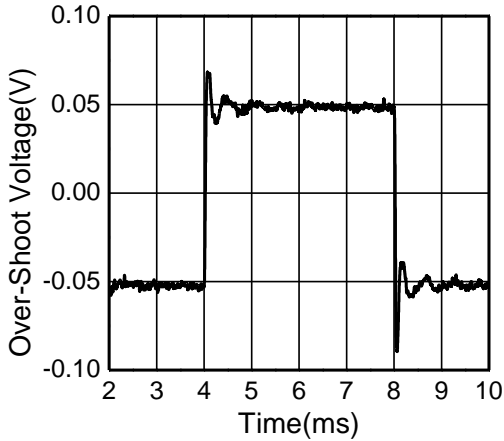
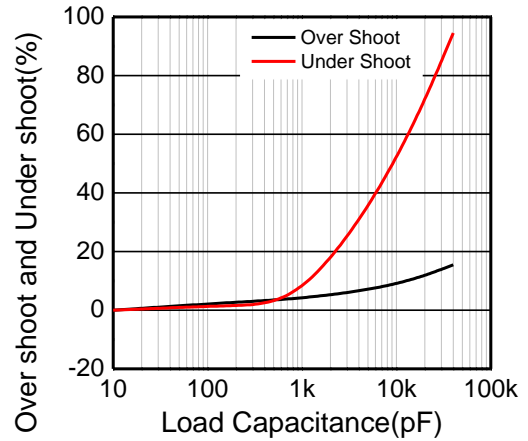
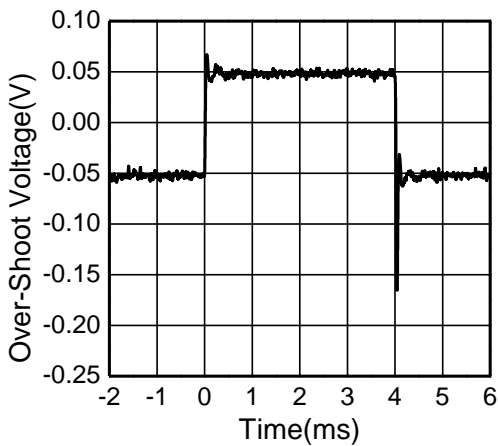
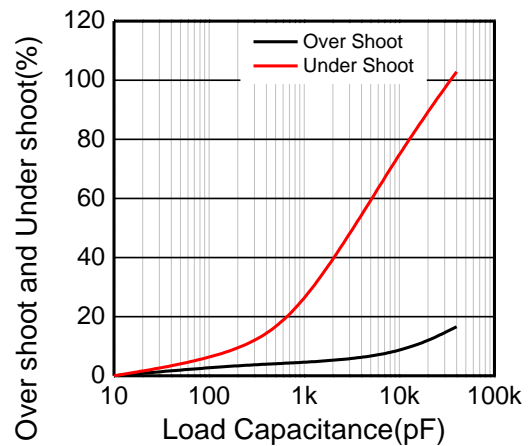
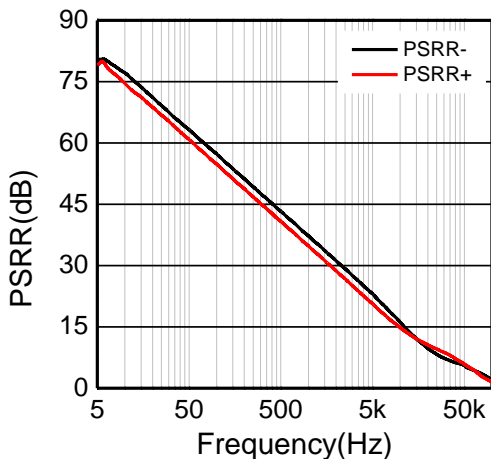
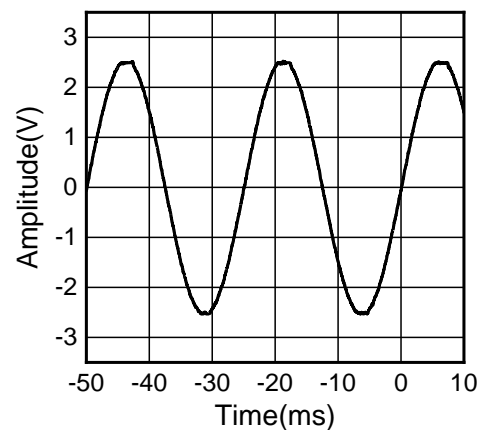
**Open-Loop Gain and Phase**

**Phase Margin vs.  $C_{\text{load}}$  (Stable for Any  $C_{\text{load}}$ )**

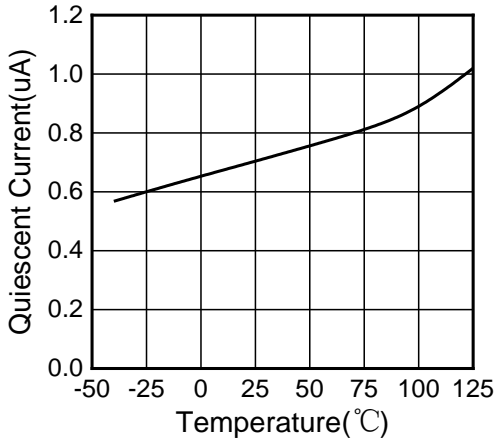
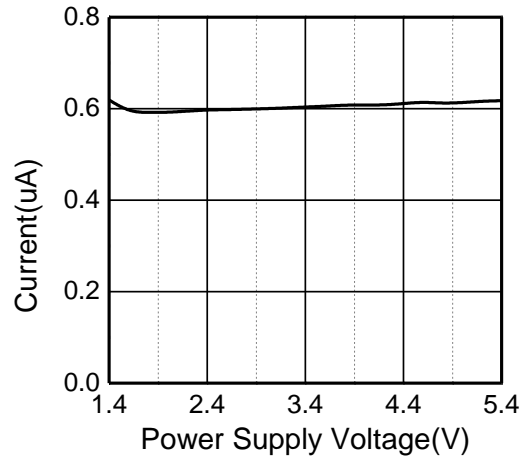
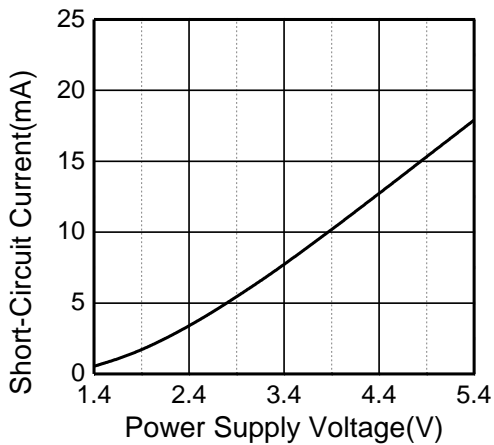
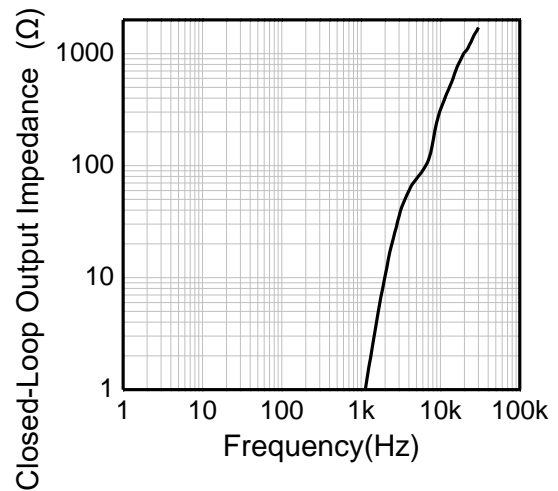
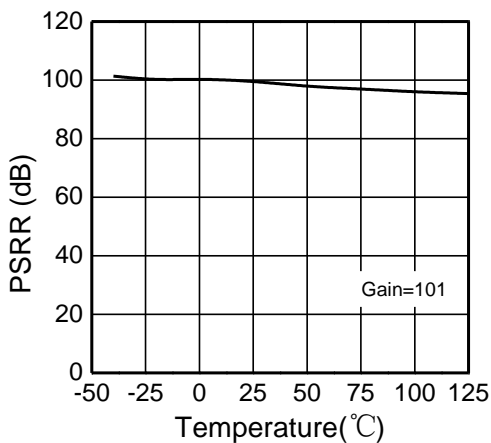
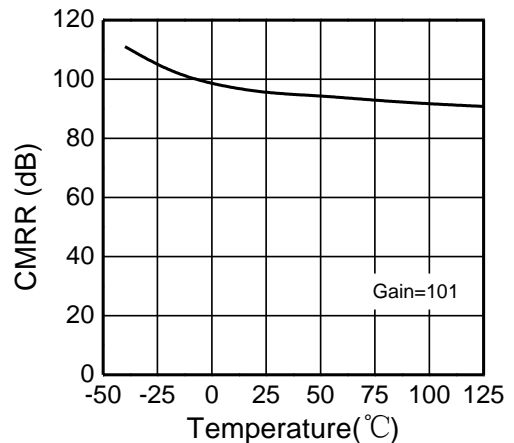
**Input Voltage Noise Spectral Density**

**CMRR vs. Frequency**

**Typical Characteristics (continued)**
 $T_A=25^{\circ}\text{C}$ ,  $V_S=5\text{V}$ ,  $V_{\text{CM}}=V_S/2$ , unless otherwise noted

**Over-Shoot Voltage**
**Gain=-1,  $C_{\text{LOAD}} = 40\text{nF}$ ,  $V_S=\pm 2.5\text{V}$** 

**Over-Shoot % vs.  $C_{\text{load}}$** 
**Gain=-1,  $C_{\text{LOAD}} = 40\text{nF}$ ,  $V_S=\pm 2.5\text{V}$** 

**Over-Shoot Voltage**
**Gain=+1,  $C_{\text{LOAD}} = 40\text{nF}$ ,  $V_S=\pm 2.5\text{V}$** 

**Over-Shoot % vs.  $C_{\text{load}}$** 
**Gain =+1,  $C_{\text{LOAD}} = 40\text{nF}$ ,  $V_S=\pm 2.5\text{V}$** 

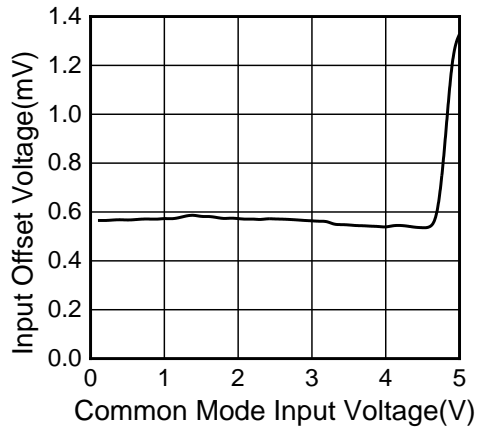
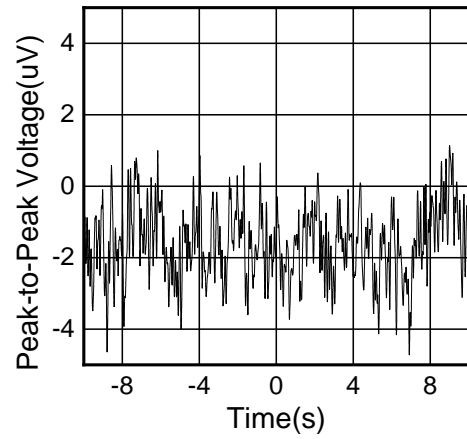
**Power-Supply Rejection Ratio**

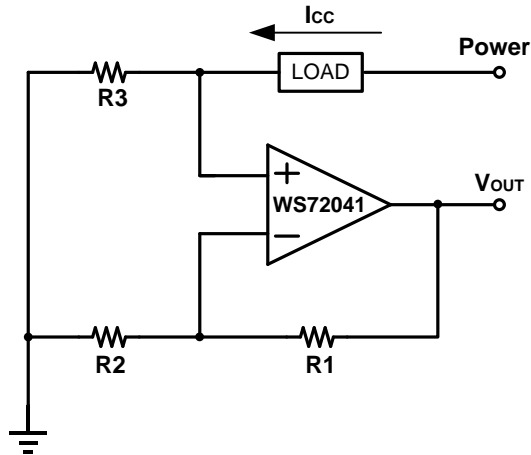
 **$V_{\text{IN}} = -0.2\text{V}$  to  $5.7\text{V}$ , No Phase Reversal**

**Typical Characteristics (continued)**
 $T_A=25^{\circ}\text{C}$ ,  $V_S=5\text{V}$ ,  $V_{\text{CM}}=V_S/2$ , unless otherwise noted

**Quiescent Supply Current vs. Temperature**

**Quiescent Supply Current vs. Supply Voltage**

**Short-Circuit Current vs. Supply Voltage**

**Closed-Loop Output Impedance vs. Frequency**

**PSRR vs. Frequency**

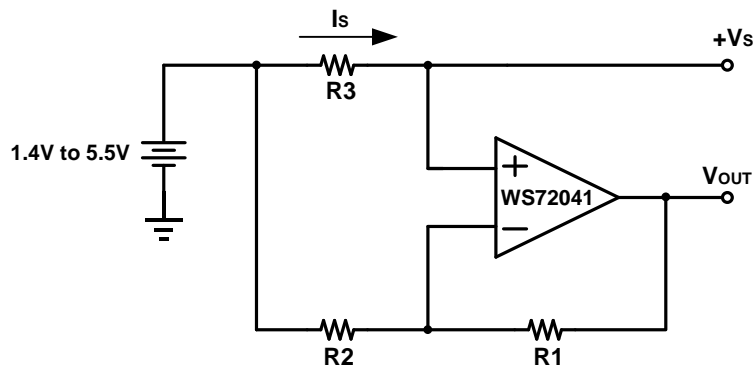
**CMRR vs. Temperature**

**Typical Characteristics (continued)**
 $T_A=25^{\circ}\text{C}$ ,  $V_S=5\text{V}$ ,  $V_{\text{CM}}=V_S/2$ , unless otherwise noted

**Input Offset Voltage vs. Common Mode  
Input Voltage**

**0.1Hz to 10Hz Time Domain Output  
Voltage Noise**

**Application Circuit**
**(1) WS72041 in Low Side Battery Current Sensor**

**Application Circuit for Low Side Battery Current Sensor**

$$V_{OUT} = I_{CC} \times R_3 \times \left( \frac{R_1}{R_2} + 1 \right)$$

**(2) WS72041 in High Side Battery Current Sensor**

**Application Circuit for High Side Battery Current Sensor**

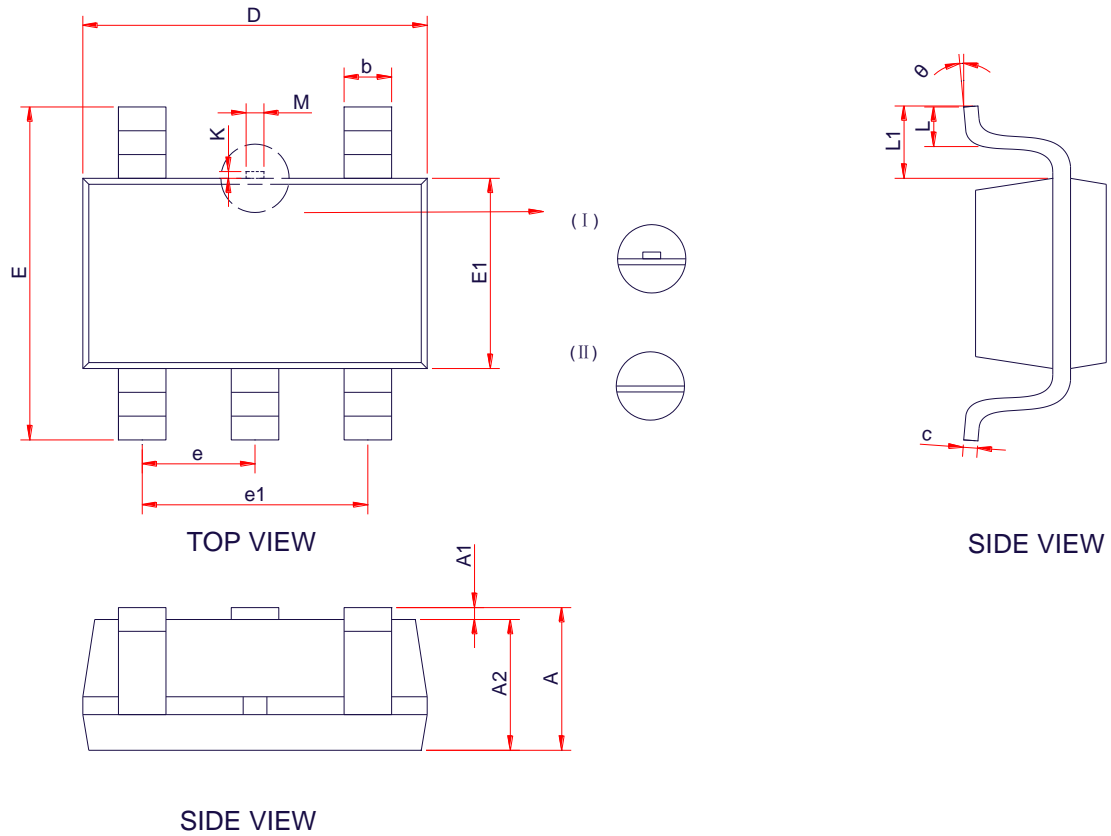
$$I_S = \frac{+V_S - V_{OUT}}{R_1 \times R_3 \div R_2}$$

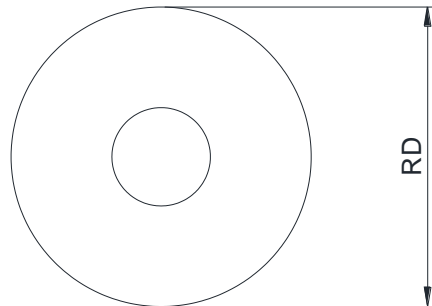
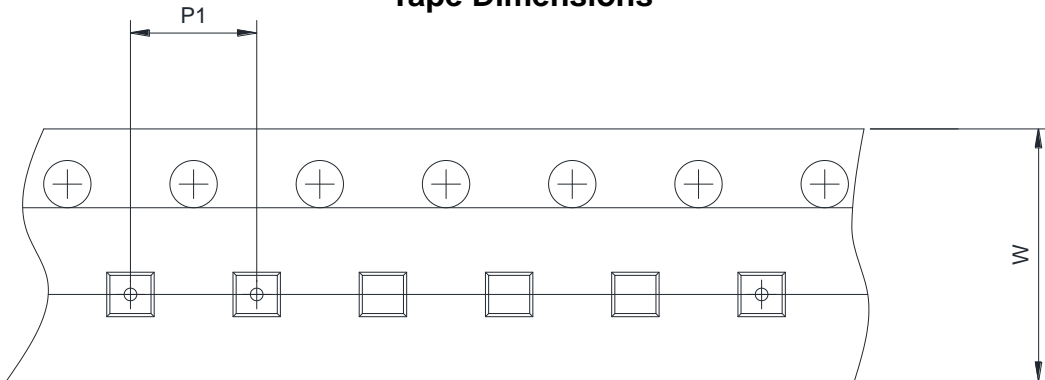
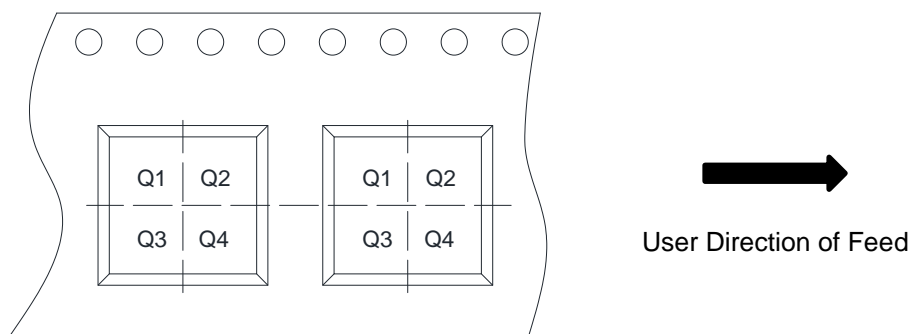

**PACKAGE OUTLINE DIMENSIONS**
**SOT-23-5L**

Symbol	Dimensions in Millimeters		
	Min.	Typ.	Max.
A	-	-	1.45
A1	0.00	-	0.15
A2	0.90	1.10	1.30
b	0.30	0.40	0.50
c	0.10	-	0.21
D	2.72	2.92	3.12
E	2.60	2.80	3.00
E1	1.40	1.60	1.80
e	0.95 BSC		
e1	1.90 BSC		
L	0.30	0.45	0.60
M	0.10	0.15	0.25
K	0.00	-	0.25
θ	0°	-	8°

**TAPE AND REEL INFORMATION**
**Reel Dimensions**

**Tape Dimensions**

**Quadrant Assignments For PIN1 Orientation In Tape**

**PACKAGE OUTLINE DIMENSIONS**

RD	Reel Dimension	<input checked="" type="checkbox"/> 7inch	<input type="checkbox"/> 13inch
W	Overall width of the carrier tape	<input checked="" type="checkbox"/> 8mm	<input type="checkbox"/> 12mm <input type="checkbox"/> 16mm
P1	Pitch between successive cavity centers	<input type="checkbox"/> 2mm	<input checked="" type="checkbox"/> 4mm <input type="checkbox"/> 8mm
Pin1	Pin1 Quadrant	<input type="checkbox"/> Q1	<input type="checkbox"/> Q2 <input checked="" type="checkbox"/> Q3 <input type="checkbox"/> Q4