

C41

Water Cooled Resonant Capacitor

Water Cooled Resonant Capacitor C41-BC2



Characteristics

- Conduction water-cooled
- Polypropylene dielectric
- Low dissipation factor($tg\delta$), low ESL and low ESR
- High voltage, high frequency and high dv/dt
- High current resistance, excellent heat dissipation

Application

- Widely used in high power and high frequency resonant devices

Technical Data

● Reference standards	GB/T 3984-2004 IEC 60110.1
● Operating temperature range	-40°C~+85°C
● Capacitance range	0.1μF~85μF
● Rated capacitance	100kVar-1500 kVar
● Rated voltage	400VAC-1100VAC
● Tolerance	±5% ±10%
● Test voltage between terminals	1.5U _{NAC} 10s
	3.5U _{NDC} 10s at 25°C±5°C
● Dissipation factor	$tg\delta \leq 5 \times 10^{-4}$ at 25°C±5°C, 1kHz
● Insulation resistance	$R \cdot C \geq 3000s$, at 100VDC, 25°C±5°C, 60s
● Life expectancy	100000h at U _N and 70°C, 30000h at Urms

Typical Circuit

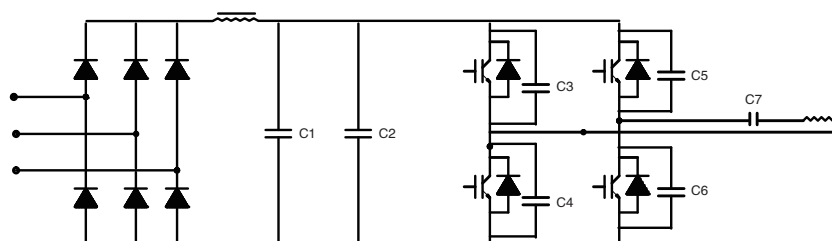

C7 is the water-cooled capacitor in the series resonant capacitor

C41

Water Cooled Resonant Capacitor

Construction Diagram

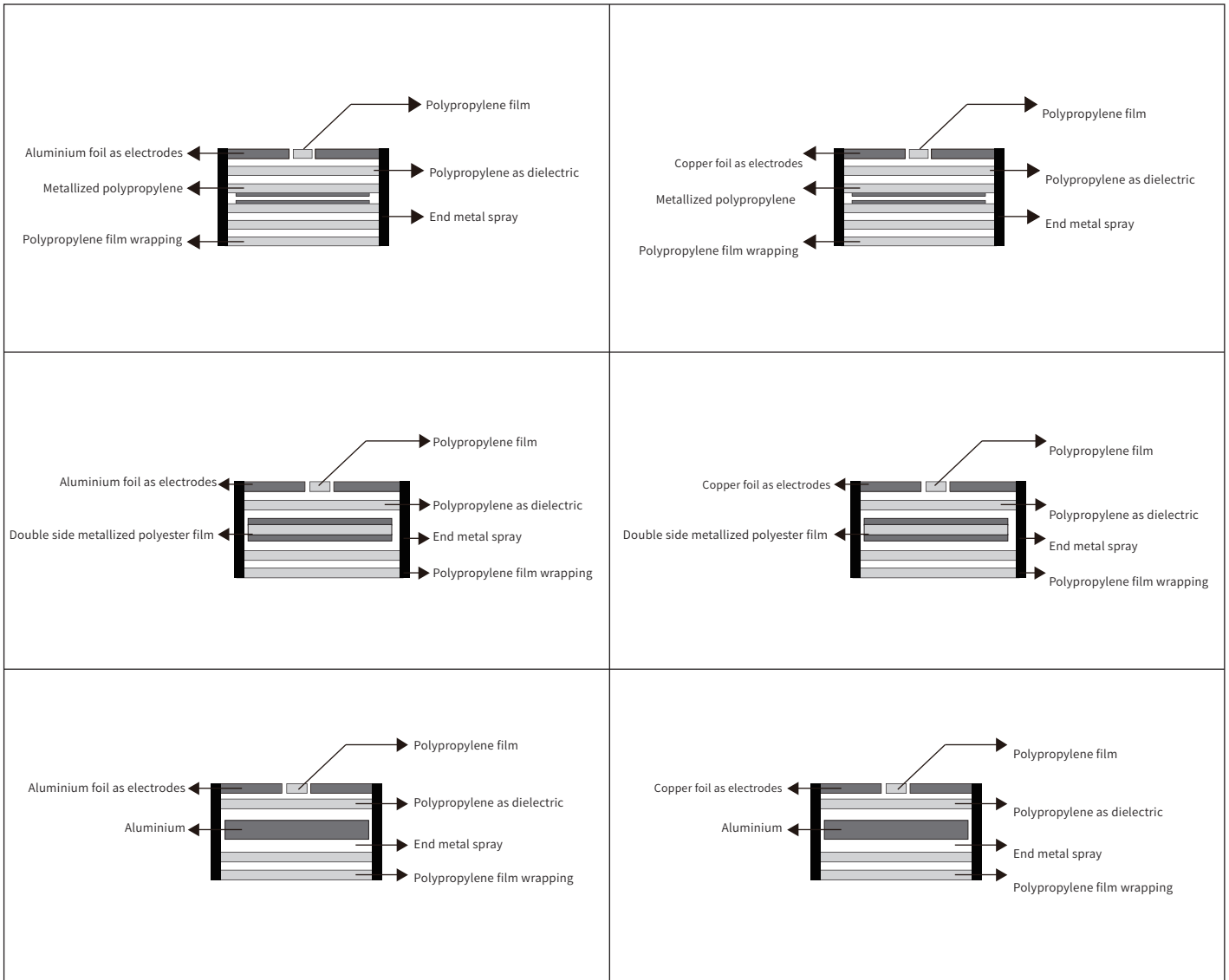

Product Coding

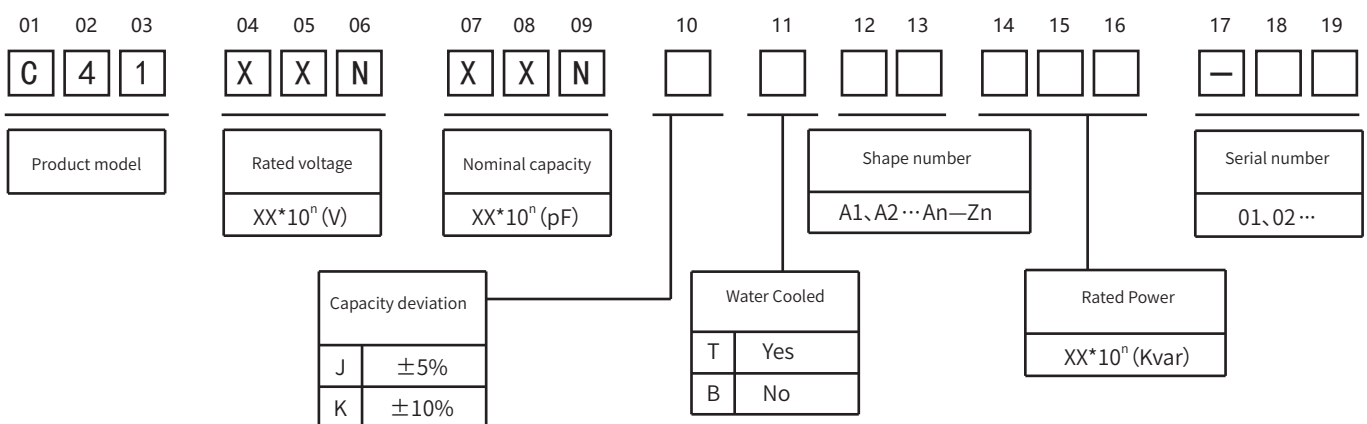

C41

Water Cooled Resonant Capacitor

C41-BC2

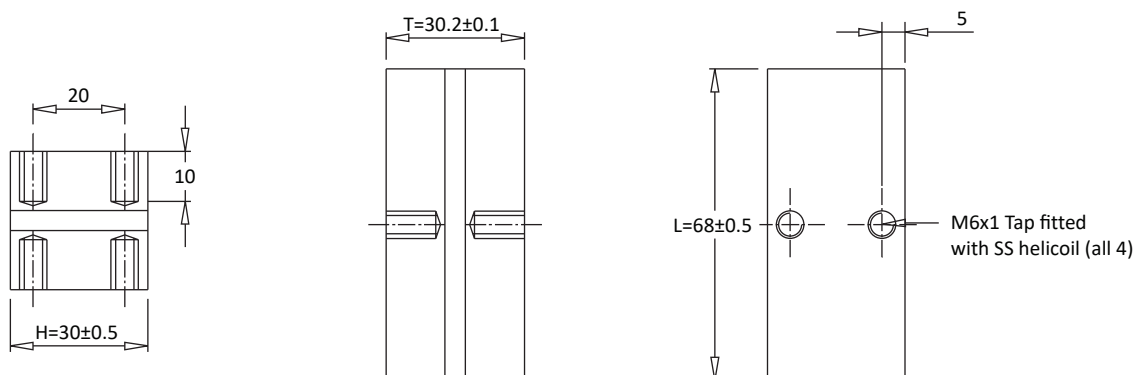

Article Table

Part Number	Rated Voltage Vrms	Nominal Capacitance μF at 1Khz	Max Irms A	Max Power kVar	Freq Range @Full Power (kHz)	ESR mΩ	Dimension (mm)			Case Code
							L	H	T	
C41102503KBC2151...	1000	0.05	200	150	478-700	1.5	68	30	30.2	BC2
C41102104KBC2151...	1000	0.10	250	150	238-423	1.5	68	30	30.2	BC2
C41701174KBC2151...	700	0.17	250	150	286-389	1.2	68	30	30.2	BC2
C41701254KBC2151...	700	0.25	250	150	195-265	1.2	68	30	30.2	BC2
C41701334KBC2151...	700	0.33	250	150	148-200	1.0	68	30	30.2	BC2
C41701504KBC2151...	700	0.50	250	150	93-132	1.0	68	30	30.2	BC2
C41601664KBC2151...	600	0.66	300	150	100-145	0.8	68	30	30.2	BC2
C41501125KBC2151...	500	1.20	300	150	79-80	0.6	68	30	30.2	BC2
C41501135KBC2151...	500	1.30	300	150	72	0.6	68	30	30.2	BC2
C41401245KBC2151...	400	2.40	400	150	63-72	0.6	68	30	30.2	BC2
C41102503KBC2201...	1000	0.05	250	200	636-994	1.5	68	30	30.2	BC2
C41102104KBC2201...	1000	0.10	250	200	318-498	1.2	68	30	30.2	BC2
C41901174KBC2201...	900	0.17	300	200	232-422	1.0	68	30	30.2	BC2
C41801254KBC2201...	800	0.25	300	200	199-286	0.9	68	30	30.2	BC2
C41801334KBC2201...	800	0.33	300	200	150-216	0.8	68	30	30.2	BC2
C41801504KBC2201...	800	0.50	350	200	98-194	0.6	68	30	30.2	BC2
C41701664KBC2201...	700	0.66	400	200	98-193	0.4	68	30	30.2	BC2
C41601125KBC2201...	600	1.20	450	200	74-134	0.4	68	30	30.2	BC2
C41601135KBC2201...	600	1.30	450	200	65-120	0.4	68	30	30.2	BC2
C41451245KBC2201...	450	2.40	500	200	65-85	0.3	68	30	30.2	BC2

The above table / graphics are for reference only, subject to the actual product (unit: mm)

C41

Water Cooled Resonant Capacitor

Temperature Characteristics

—◆— Voltage —■— Current —▲— Power

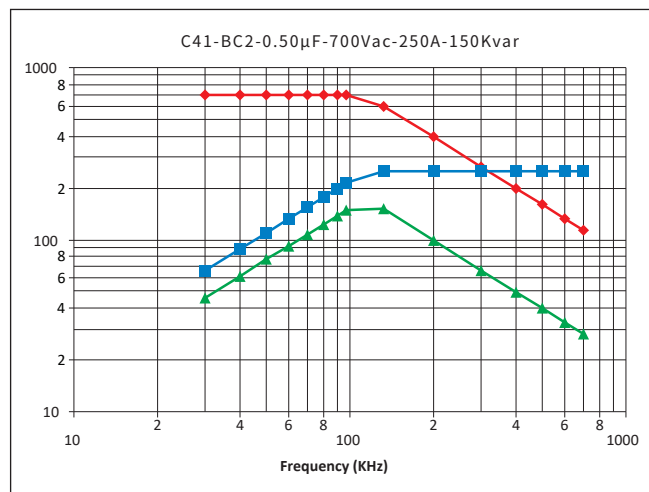
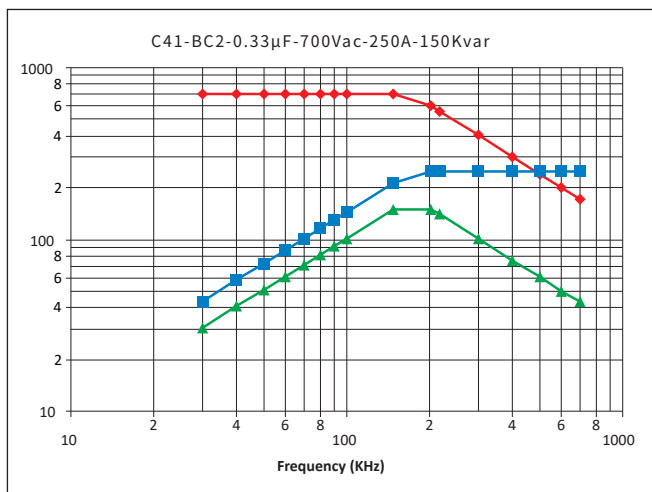
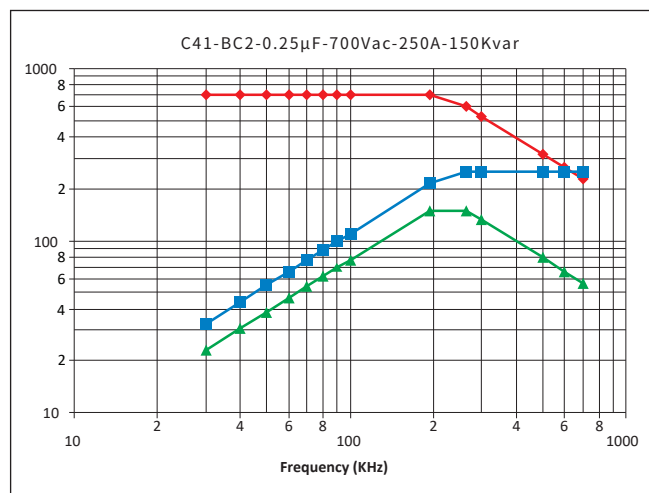
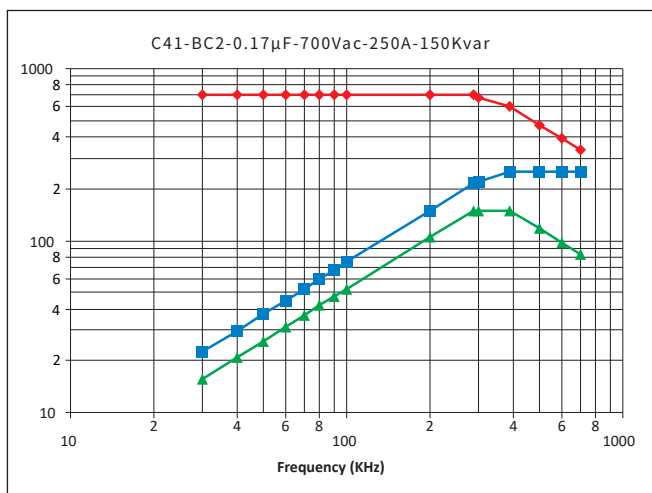
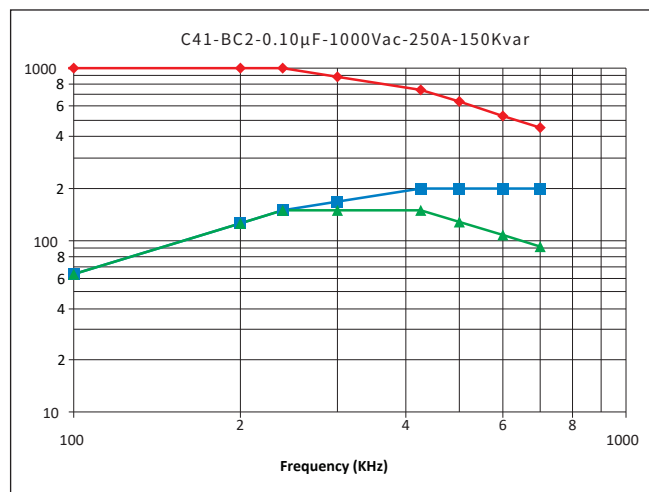
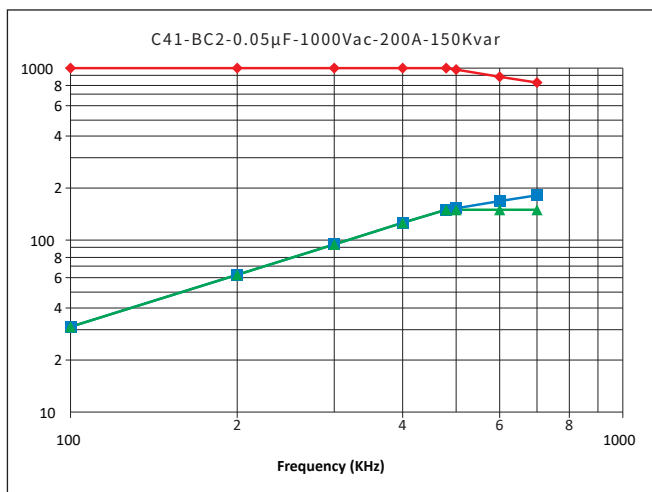

C41

Water Cooled Resonant Capacitor

Temperature Characteristics

—◆— Voltage —■— Current —▲— Power

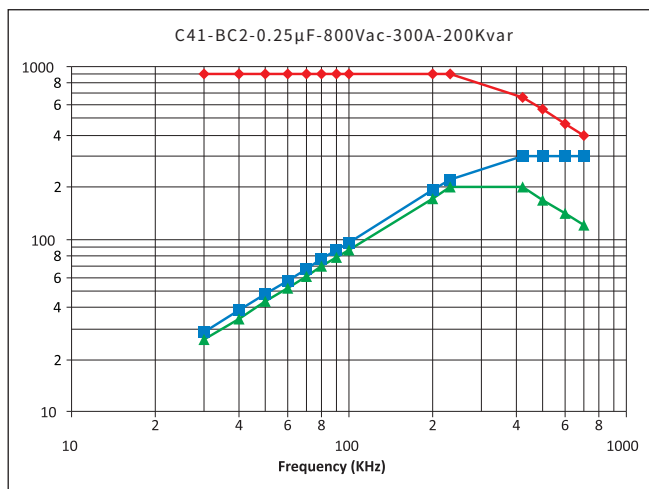
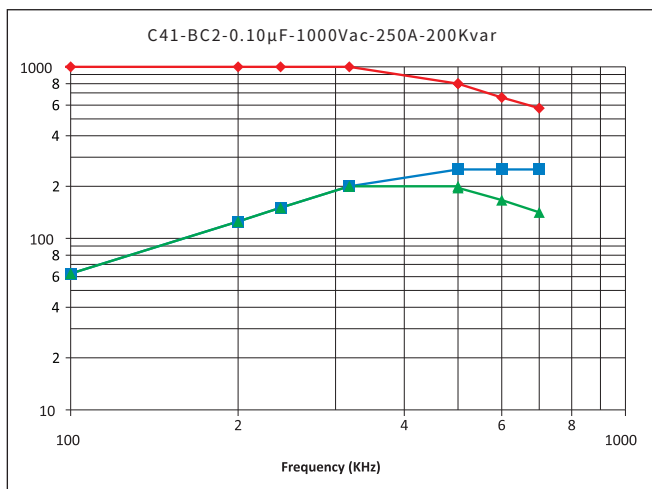
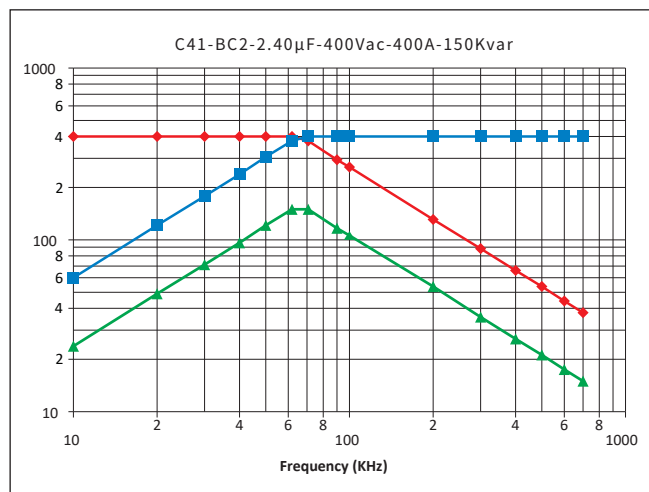
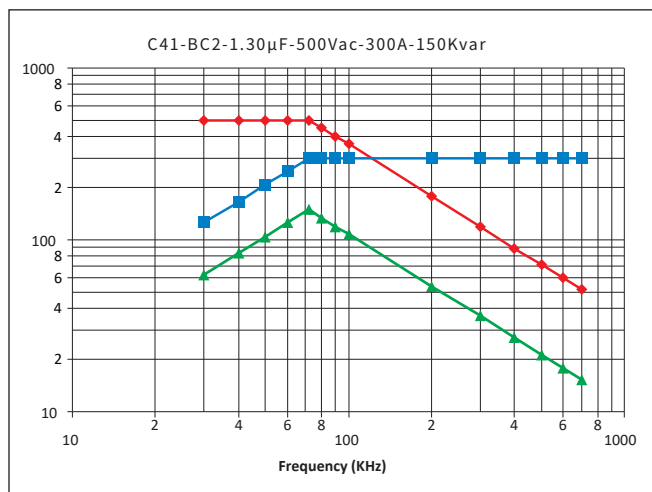
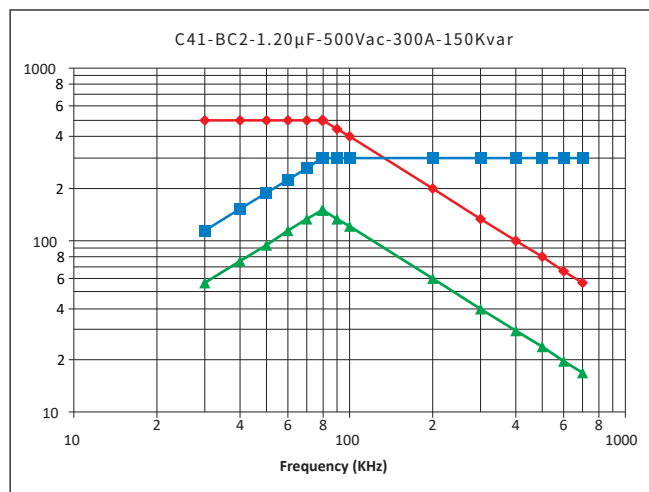
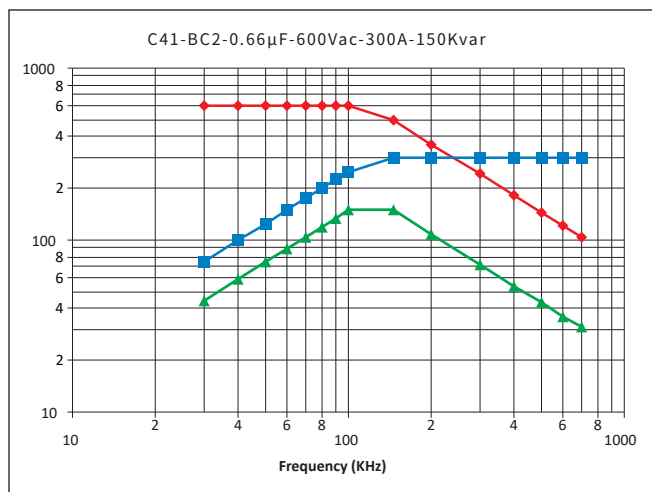

C41

Water Cooled Resonant Capacitor

Temperature Characteristics

—●— Voltage —■— Current —▲— Power

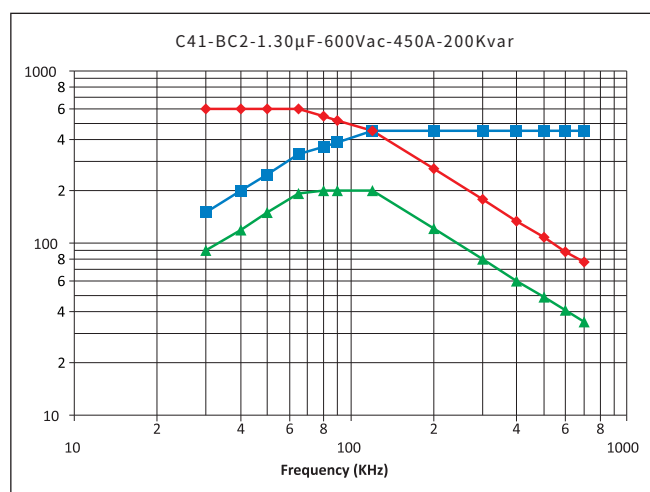
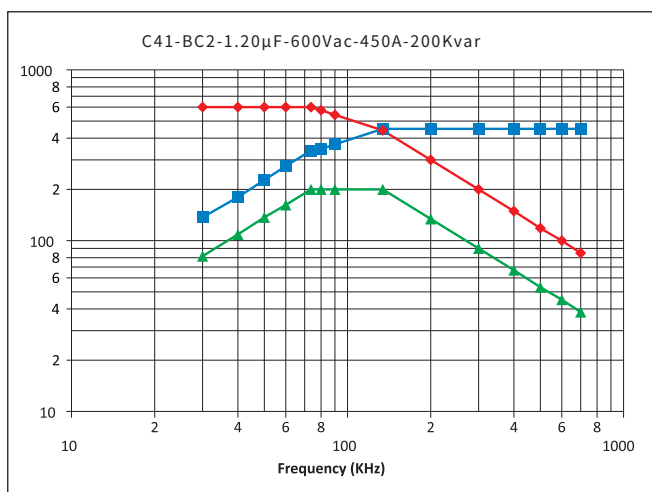
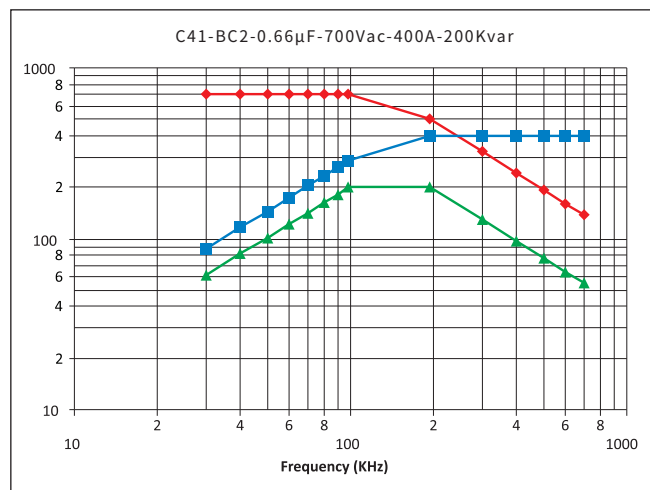
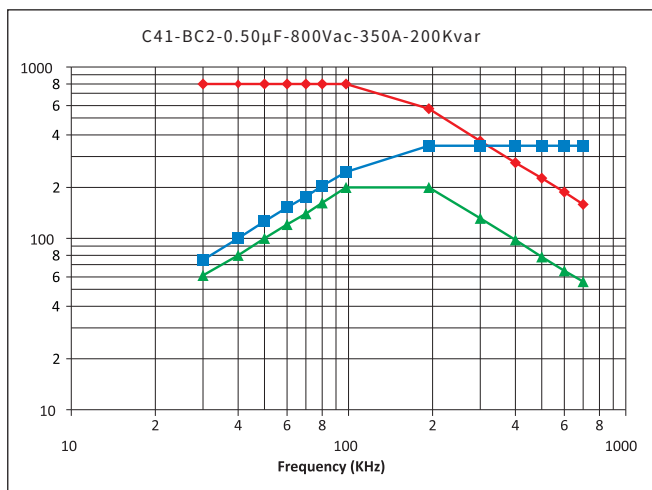
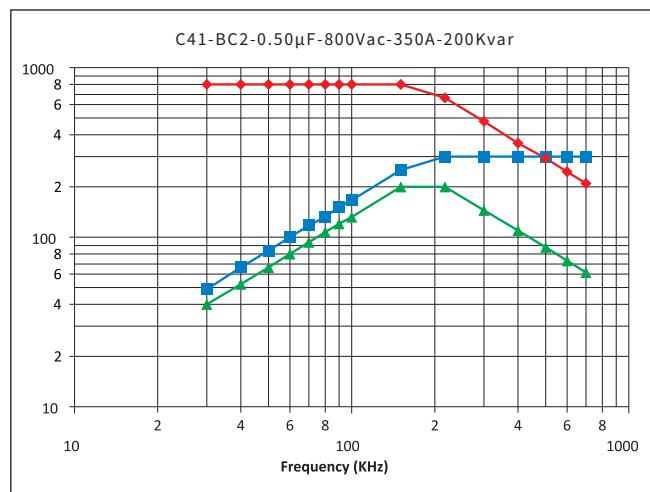
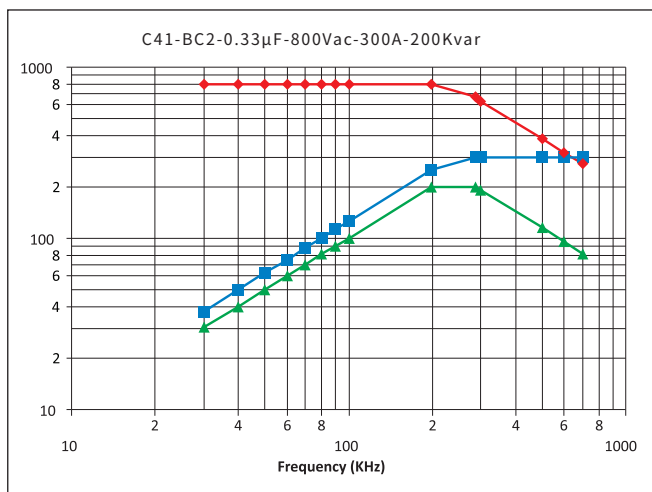

C41

Water Cooled Resonant Capacitor

Temperature Characteristics

—◆— Voltage —■— Current —▲— Power

