

C41

Water Cooled Resonant Capacitor

Water Cooled Resonant Capacitor C41-BB3



Characteristics

- Conduction water-cooled
- Polypropylene dielectric
- Low dissipation factor($\text{tg}\delta$), low ESL and low ESR
- High voltage, high frequency and high dv/dt
- High current resistance, excellent heat dissipation

Application

- Widely used in high power and high frequency resonant devices

Technical Data

● Reference standards	GB/T 3984-2004 IEC 60110.1
● Operating temperature range	-40°C~+85°C
● Capacitance range	0.1µF~85µF
● Rated capacitance	100kVar-1500 kVar
● Rated voltage	400VAC-1100VAC
● Tolerance	±5% ±10%
● Test voltage between terminals	1.5 U_{NAC} 10s
	3.5 U_{NDC} 10s at 25°C±5°C
● Dissipation factor	$\text{tg}\delta \leq 5 \times 10^{-4}$ at 25°C±5°C, 1kHz
● Insulation resistance	$R \cdot C \geq 3000\text{s}$, at 100VDC, 25°C±5°C, 60s
● Life expectancy	100000h at U_{N} and 70°C, 30000h at U_{rms}

Typical Circuit

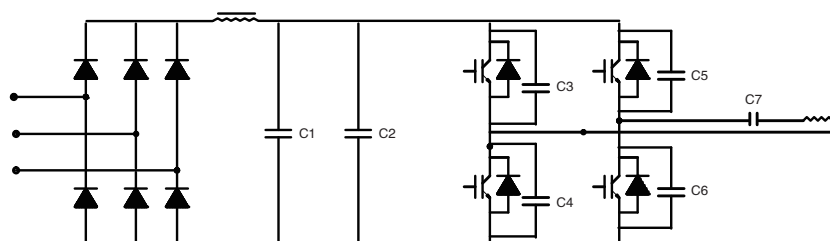

C7 is the water-cooled capacitor in the series resonant capacitor

C41

Water Cooled Resonant Capacitor

Construction Diagram

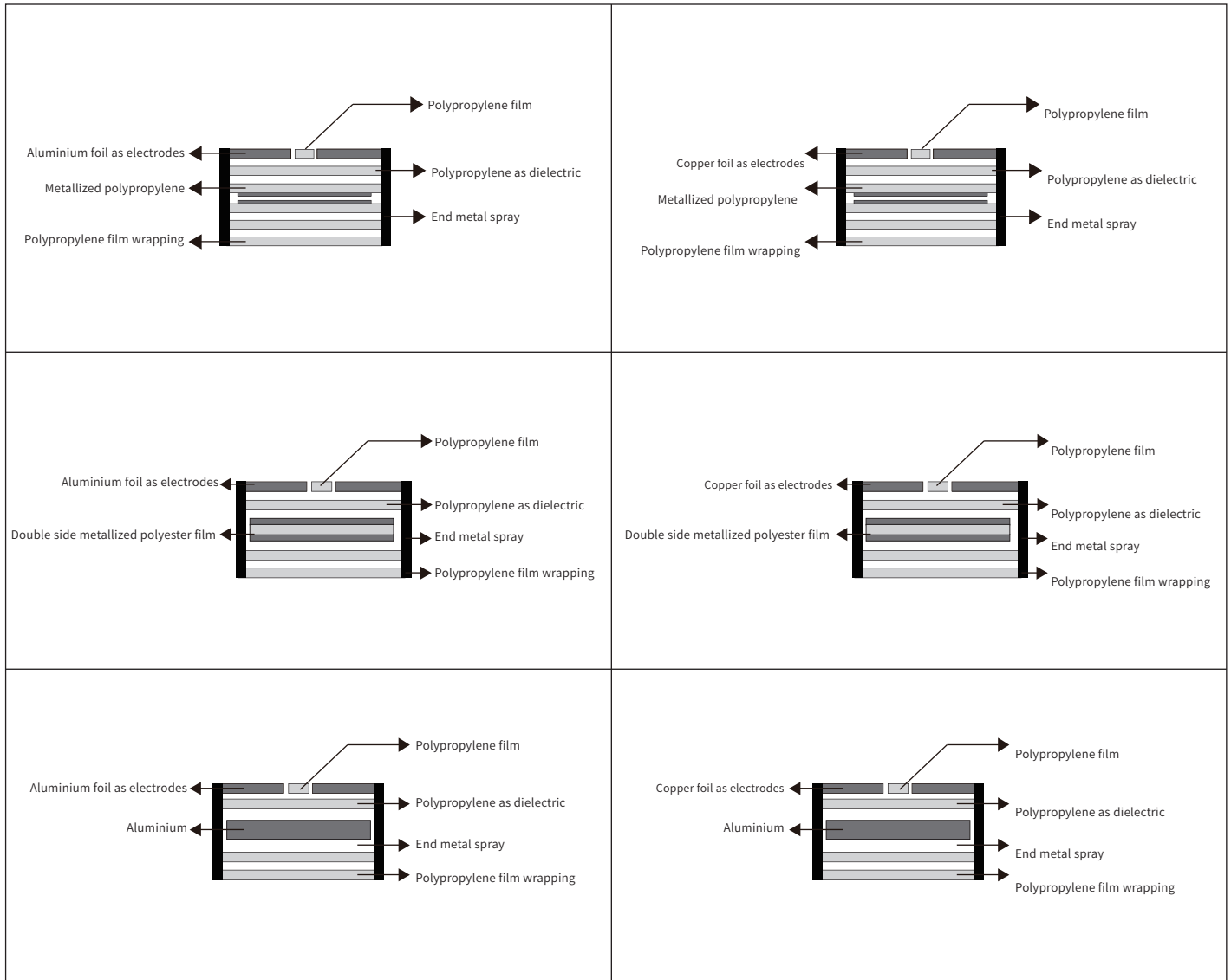

Product Coding

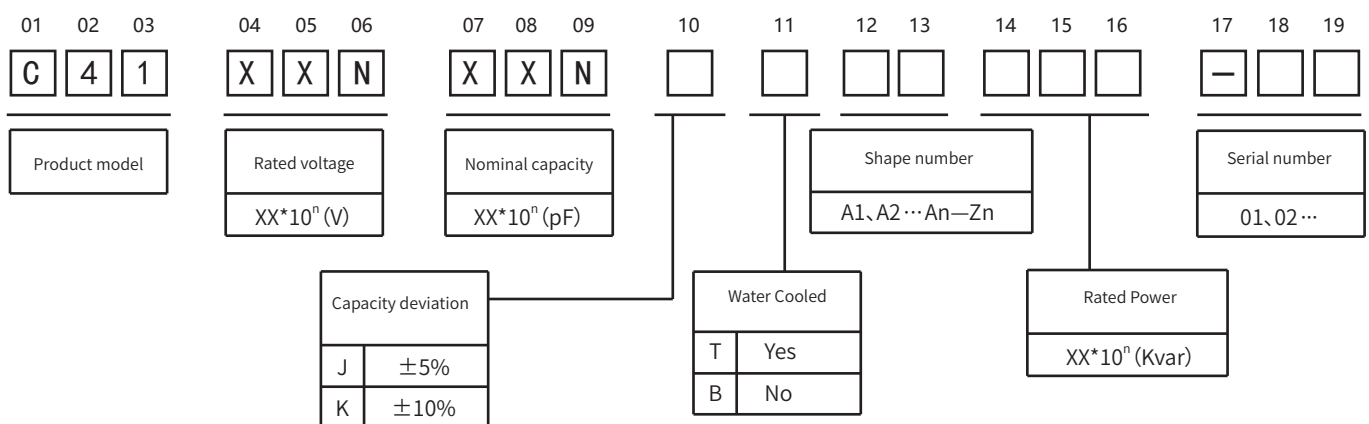

C41

Water Cooled Resonant Capacitor

C41—BB3

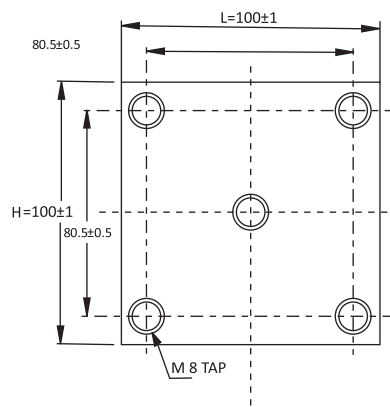
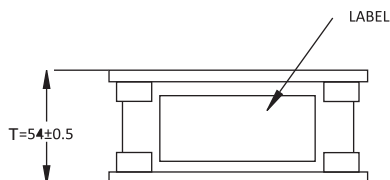

Article Table

Part Number	Rated Voltage Vrms	Nominal Capacitance μF at 1Khz	Max Irms A	Max Power kVar	Freq Range @Full Power (kHz)	ESR mΩ	Dimension (mm)			Case Code
							L	H	T	
C41601655KBB3401...	600	6.50	1000	400	27-62	1.2	100	100	54	BB3
C41601855KBB3401...	600	8.50	1000	400	30-47	1.0	100	100	54	BB3
C41601106KBB3401...	600	10.00	1000	400	18-40	0.8	100	100	54	BB3
C41501206KBB3401...	500	20.00	1000	400	13-15	0.6	100	100	54	BB3
C41401406KBB3401...	400	40.00	1000	400	10	0.4	100	100	54	BB3

Part Number	Rated Voltage Vrms	Nominal Capacitance μF at 1Khz	Max Irms A	Max Power kVar	Freq Range @Full Power (kHz)	ESR mΩ	Dimension (mm)			Case Code
							L	H	T	
C41112125KBB3501...	1100	1.2	600	500	55-96	1.5	100	100	54	BB3
C41112145KBB3501...	1100	1.4	600	500	46-83	1.2	100	100	54	BB3
C41751305KBB3501...	750	3.0	800	500	47-68	1.1	100	100	54	BB3
C41751335KBB3501...	750	3.3	800	500	43-62	1.0	100	100	54	BB3
C41901405KBB3501...	900	4.0	700	500	25-39	0.9	100	100	54	BB3
C41701565KBB3501...	700	5.6	1000	500	29-57	0.9	100	100	54	BB3
C41701635KBB3501...	700	6.3	1000	500	26-51	0.8	100	100	54	BB3
C41701855KBB3501...	700	8.5	1000	500	19-38	0.7	100	100	54	BB3
C41701106KBB3501...	700	10	1000	500	16-32	0.6	100	100	54	BB3
C41501216KBB3501...	500	21	1000	500	15	0.4	100	100	54	BB3
C41551276KBB3501...	550	27	1000	500	10-12	0.3	100	100	54	BB3
C41501336KBB3501...	500	33	1000	500	10	0.3	100	100	54	BB3
C41501376KBB3501...	500	37	1000	500	9	0.2	100	100	54	BB3

C41

Water Cooled Resonant Capacitor

Part Number	Rated Voltage Vrms	Nominal Capacitance μF at 1KHz	Max Irms A	Max Power kVar	Freq Range @Full Power (kHz)	ESR m Ω	Dimension (mm)			Case Code
							L	H	T	
C41102334KBB3601...	1000	0.33	600	600	290	1.0	100	100	54	BB3
C41102504KBB3601...	1000	0.50	700	600	191-260	0.9	100	100	54	BB3
C41102664KBB3601...	1000	0.66	700	600	145-197	0.8	100	100	54	BB3
C41901135KBB3601...	900	1.33	950	600	89-180	0.3	100	100	54	BB3
C41701265KBB3601...	700	2.60	1050	600	76-112	0.3	100	100	54	BB3
C41501505KBB3601...	500	5.00	1200	600	76	0.2	100	100	54	BB3

Temperature Characteristics

—●— Voltage —■— Current —▲— Power

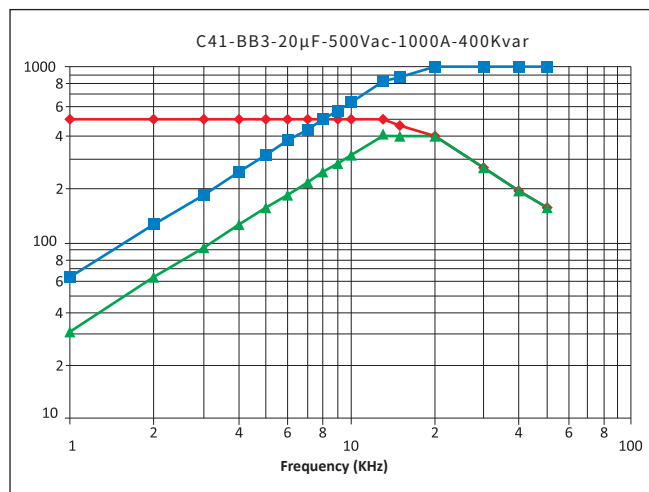
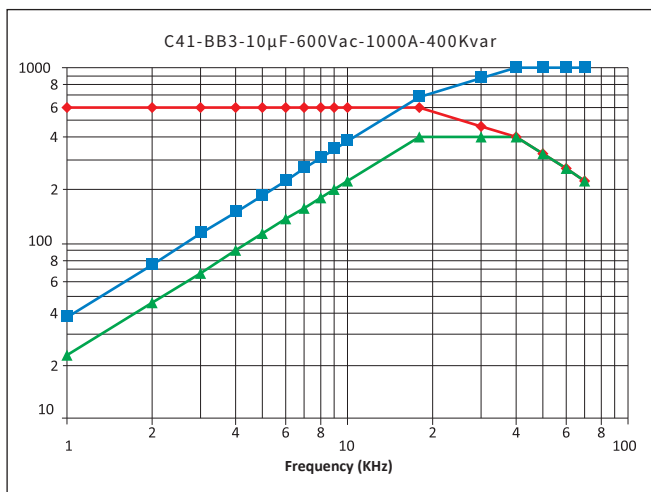
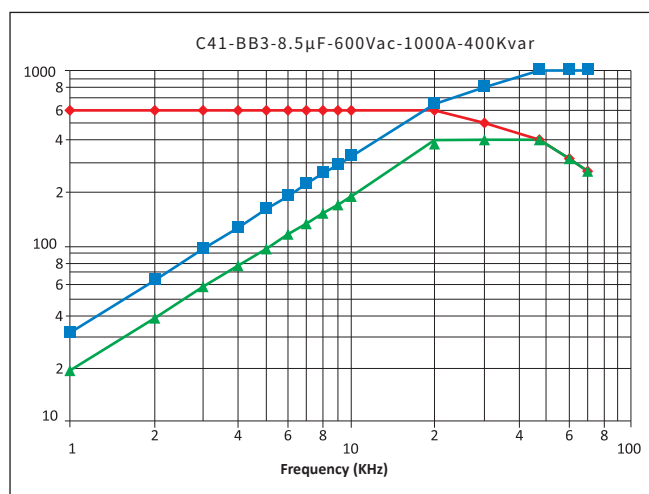
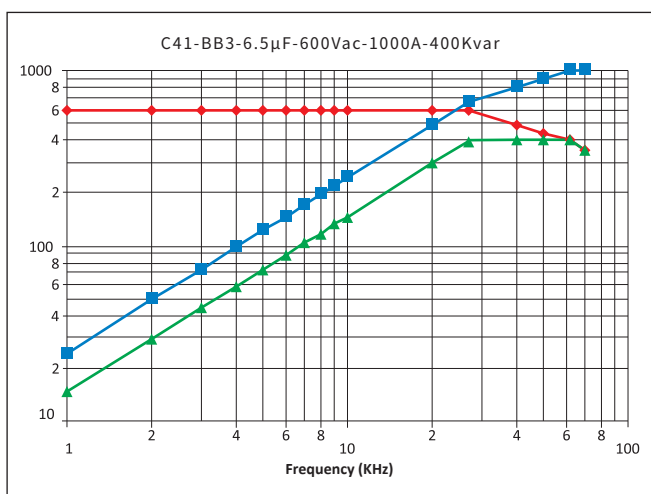

C41

Water Cooled Resonant Capacitor

Temperature Characteristics

—●— Voltage —■— Current —▲— Power

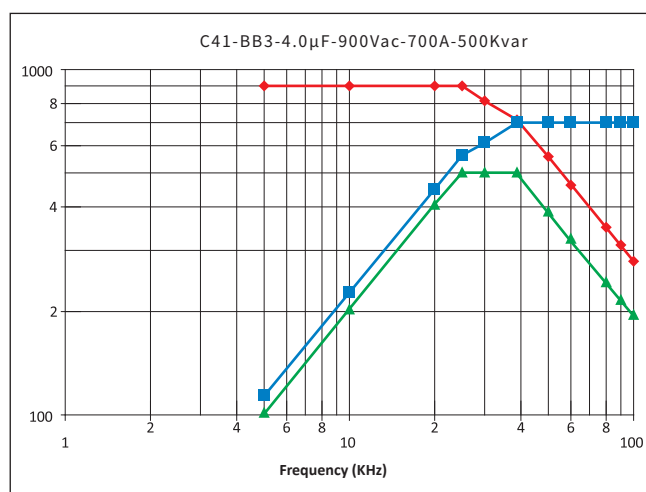
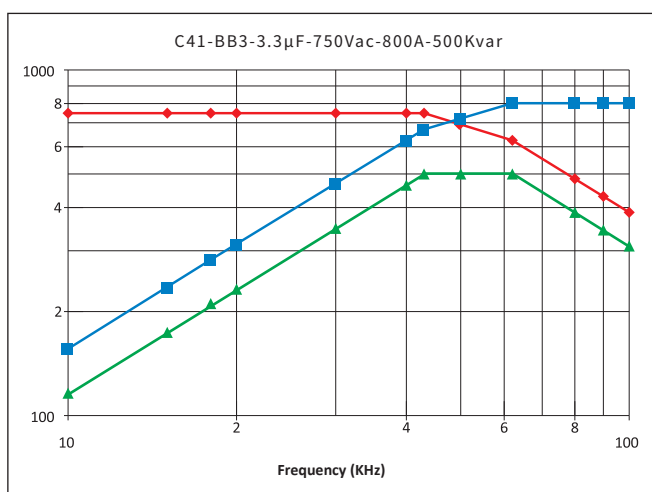
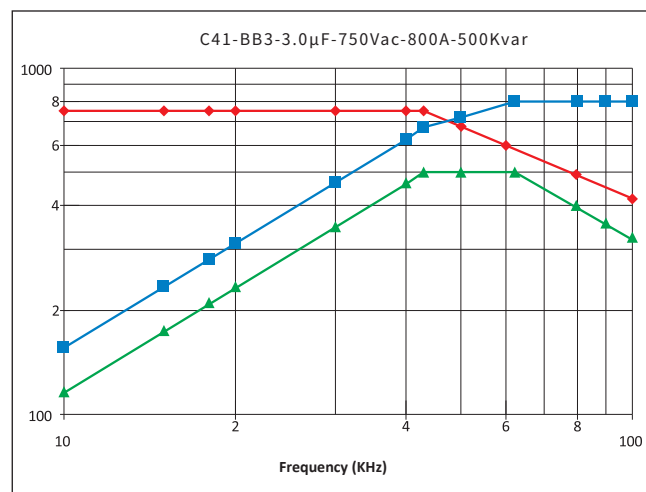
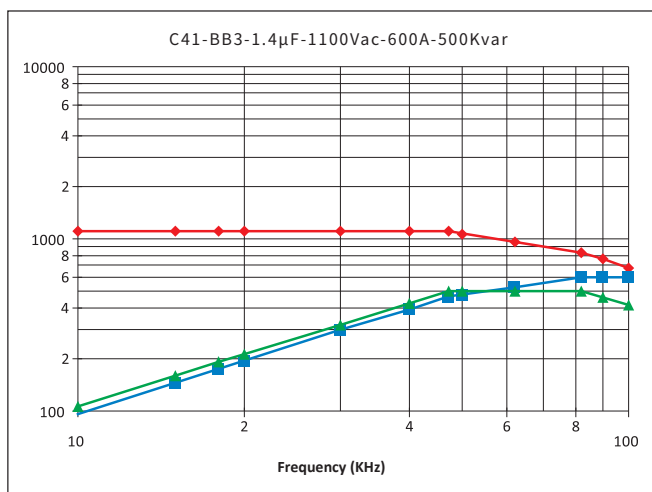
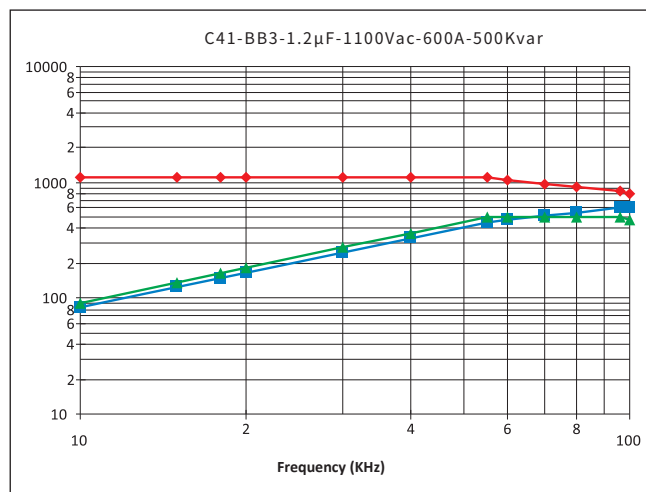
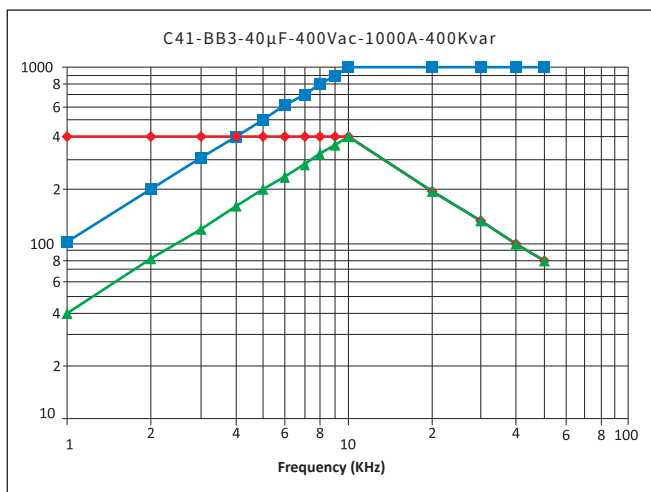

C41

Water Cooled Resonant Capacitor

Temperature Characteristics

—●— Voltage —■— Current —▲— Power

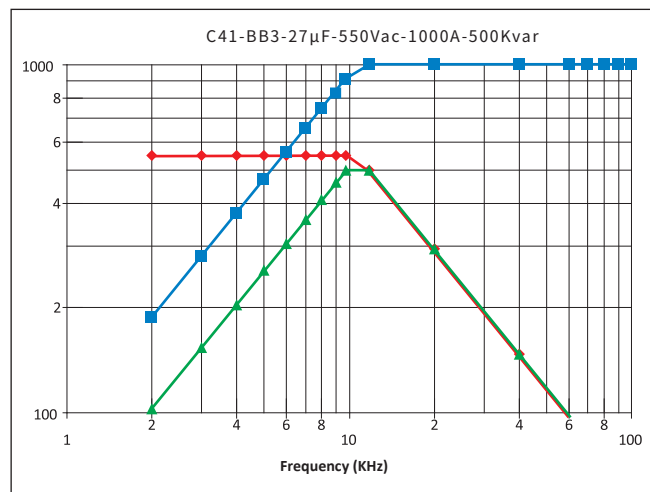
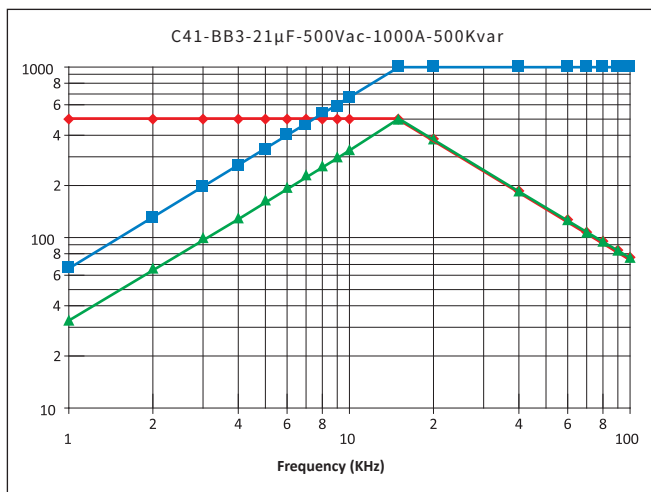
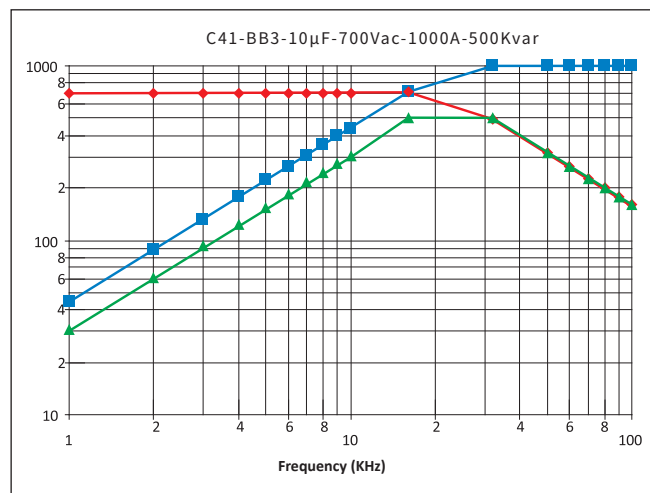
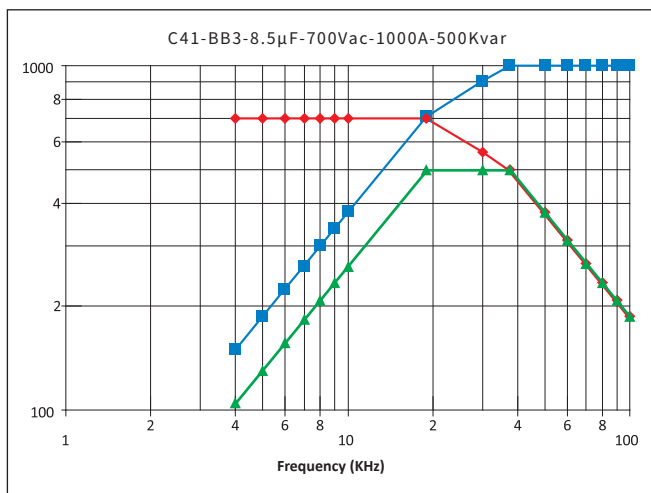
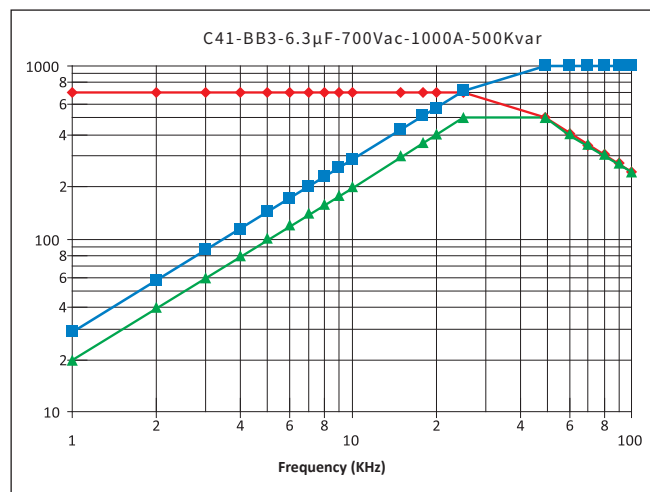
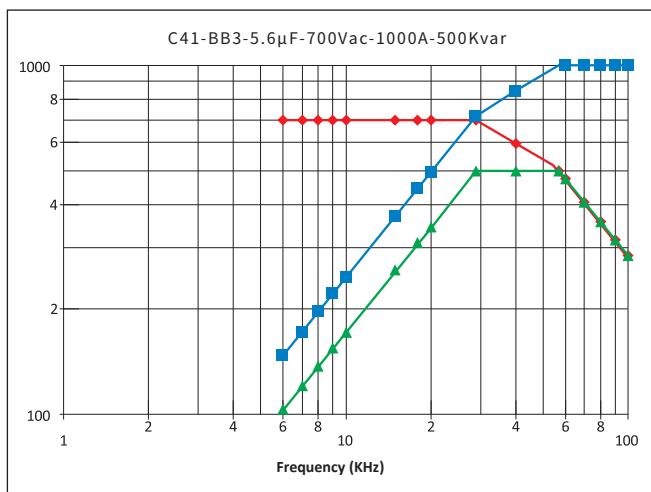

C41

Water Cooled Resonant Capacitor

Temperature Characteristics

—●— Voltage —■— Current —▲— Power

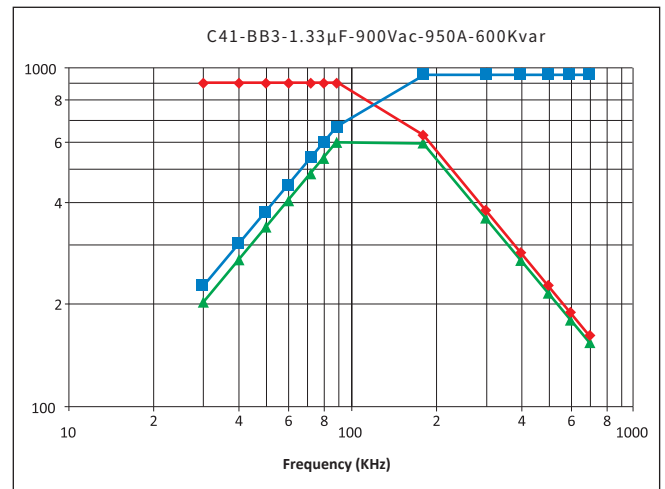
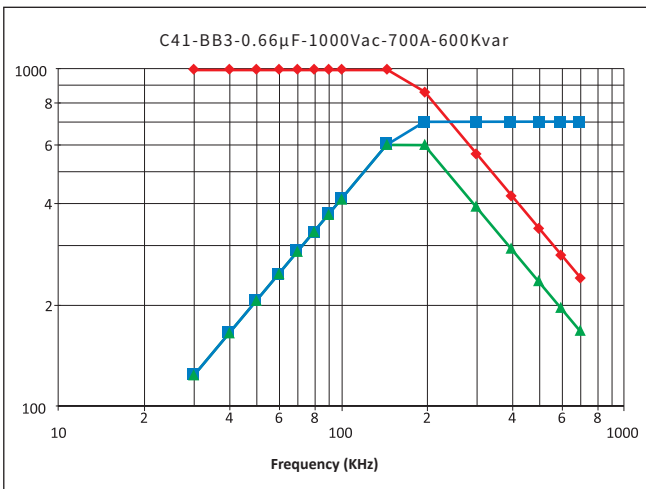
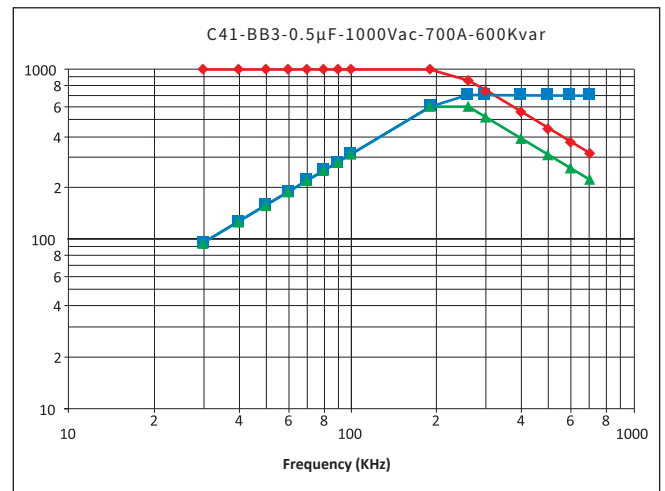
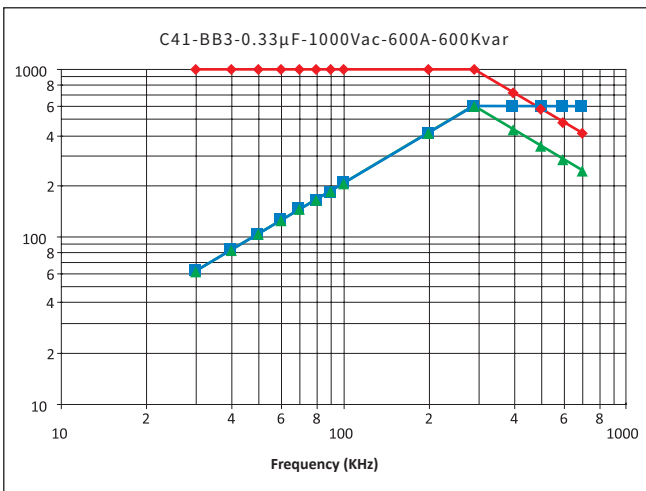
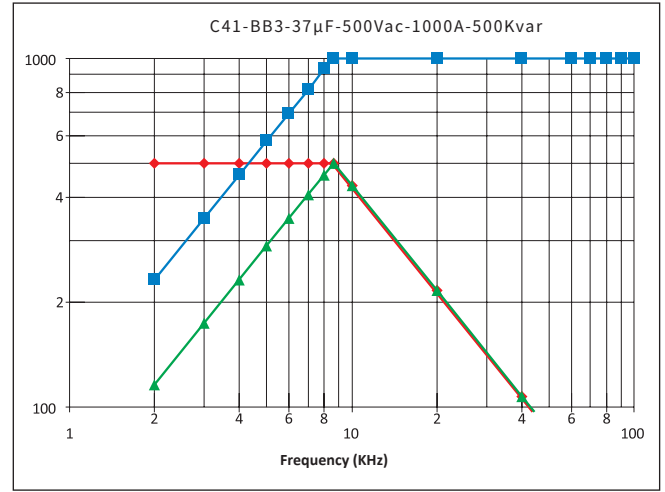
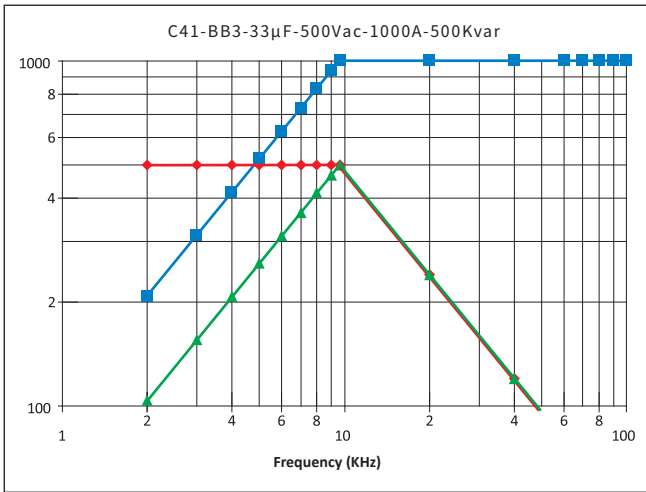

C41

Water Cooled Resonant Capacitor

Temperature Characteristics

—◆— Voltage —■— Current —▲— Power

