

Features

- Halogen Free Available Upon Request By Adding Suffix "-HF"
- Moisture Sensitivity Level 1
- Epoxy Meets UL 94 V-0 Flammability Rating
- Lead Free Finish/RoHS Compliant ("P" Suffix Designates RoHS Compliant. See Ordering Information)

Maximum Ratings

- Operating Junction Temperature Range: -55°C to +150°C
- Storage Temperature Range: -55°C to +150°C
- Thermal Resistance: 250 °C/W Junction to Ambient

| Parameter | Symbol | Rating | Unit |
|-----------------------------|-----------|--------|-----------------------|
| Collector-Base Voltage | V_{CBO} | -100 | V |
| Collector-Emitter Voltage | V_{CEO} | -80 | V |
| Emitter-Base Voltage | V_{EBO} | -5 | V |
| Collector Current | I_C | -1.0 | A |
| Collector Power Dissipation | P_C | 500 | mW ^(Note1) |
| | | 950 | mW ^(Note2) |
| | | 1350 | mW ^(Note3) |

Internal Structure

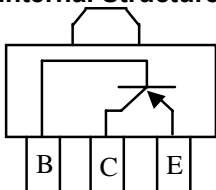

Marking:
BCX53=AH,
BCX53-10=AK
BCX53-16=AL

PNP Plastic Encapsulate Transistor

SOT-89

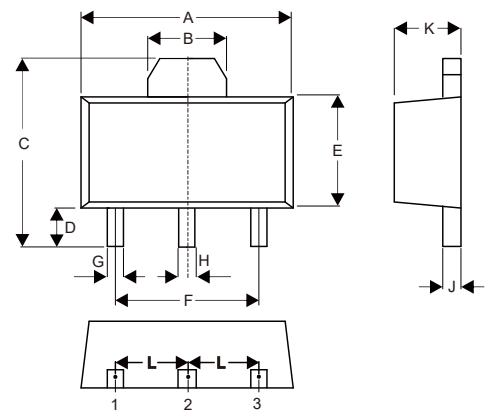

DIMENSIONS

| DIM | INCHES | | MM | | NOTE |
|-----|--------|-------|------|------|------|
| | MIN | MAX | MIN | MAX | |
| A | 0.169 | 0.185 | 4.30 | 4.70 | |
| B | 0.061 | | 1.55 | | TYP. |
| C | 0.154 | 0.171 | 3.91 | 4.35 | |
| D | 0.031 | 0.047 | 0.80 | 1.20 | |
| E | 0.089 | 0.104 | 2.25 | 2.65 | |
| F | 0.118 | | 3.00 | | TYP. |
| G | 0.013 | 0.020 | 0.33 | 0.52 | |
| H | 0.015 | 0.021 | 0.38 | 0.53 | |
| J | 0.014 | 0.017 | 0.35 | 0.44 | |
| K | 0.055 | 0.063 | 1.40 | 1.60 | |
| L | 0.059 | | 1.50 | | TYP. |

Suggested Solder Pad Layout

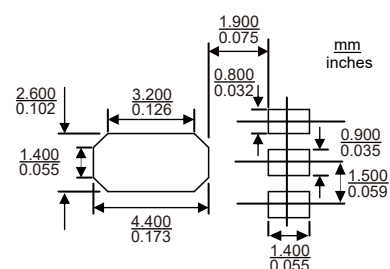

Electrical Characteristics @ 25°C Unless Otherwise Specified

| Parameter | Symbol | Min | Typ | Max | Units | Conditions |
|---|---------------|------|-----|------|---------|-----------------------------------|
| Collector-Base Breakdown Voltage | $V_{(BR)CBO}$ | -100 | | | V | $I_C=-100\mu A, I_E=0$ |
| Collector-Emitter Breakdown Voltage ^(Note4) | $V_{(BR)CEO}$ | -80 | | | V | $I_C=-10mA, I_B=0$ |
| Emitter-Base Breakdown Voltage | $V_{(BR)EBO}$ | -5 | | | V | $I_E=-100\mu A, I_C=0$ |
| Collector Cutoff Current | I_{CBO} | | | -0.1 | μA | $V_{CB}=-30V, I_E=0$ |
| Emitter-Base Cutoff Current | I_{EBO} | | | -0.1 | μA | $V_{EB}=-5V, I_C=0$ |
| DC Current Gain ^(Note4) | h_{FE1} | 63 | | | | $V_{CE}=-2V, I_C=-5mA$ |
| DC Current Gain ^(Note4) | BCX53 | 63 | | 250 | | $V_{CE}=-2V, I_C=-150mA$ |
| | BCX53-10 | 63 | | 160 | | |
| | BCX53-16 | 100 | | 250 | | |
| DC Current Gain ^(Note4) | h_{FE3} | 40 | | | | $V_{CE}=-2V, I_C=-500mA$ |
| Collector-Emitter Saturation Voltage ^(Note4) | $V_{CE(sat)}$ | | | -0.5 | V | $I_C=-500mA, I_B=-50mA$ |
| Base-Emitter Saturation Voltage ^(Note4) | $V_{BE(sat)}$ | | | -1.0 | V | $I_C=-500mA, V_{CE}=-2.0V$ |
| Transition Frequency | f_T | | 50 | | MHz | $V_{CE}=-5V, I_C=-10mA, f=100MHz$ |

Note:

1. Device mounted on an FR4 Printed-Circuit Board (PCB), single-sided copper, tin-plated and standard footprint.
2. Device mounted on an FR4 PCB, single-sided copper, tin-plated, mounting pad for collector 1 cm².
3. Device mounted on an FR4 PCB, single-sided copper, tin-plated, mounting pad for collector 6 cm².
4. Pulse Test

Curve Characteristics

Fig. 1 - Static Characteristics

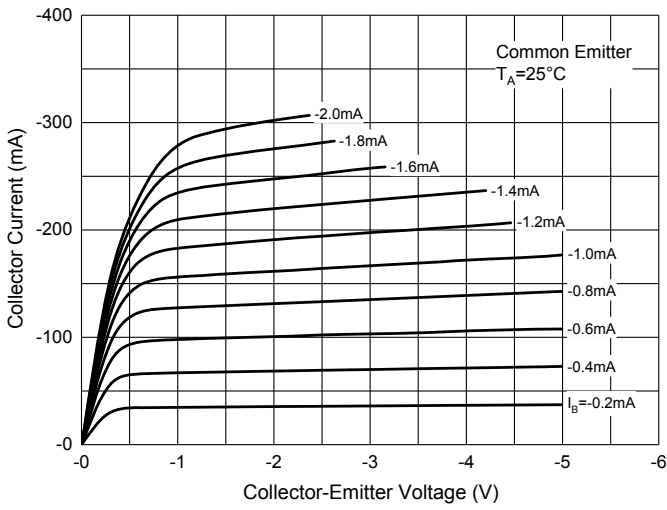

Fig. 2 - DC Current Gain Characteristics

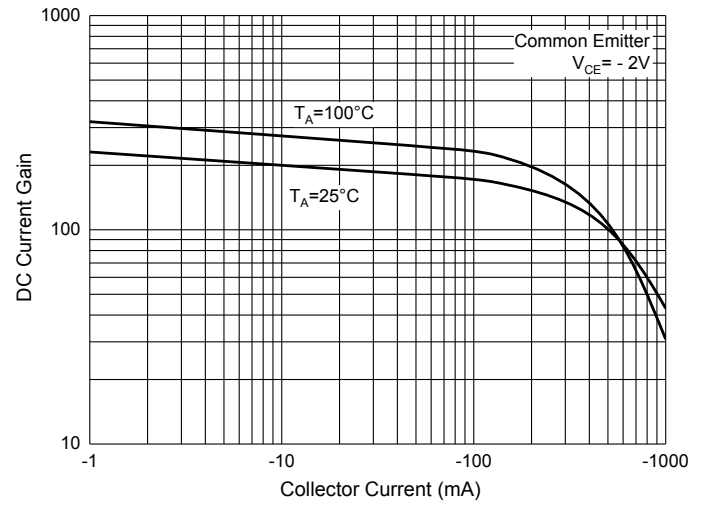

Fig. 3 - Base-Emitter Saturation Voltage Characteristics

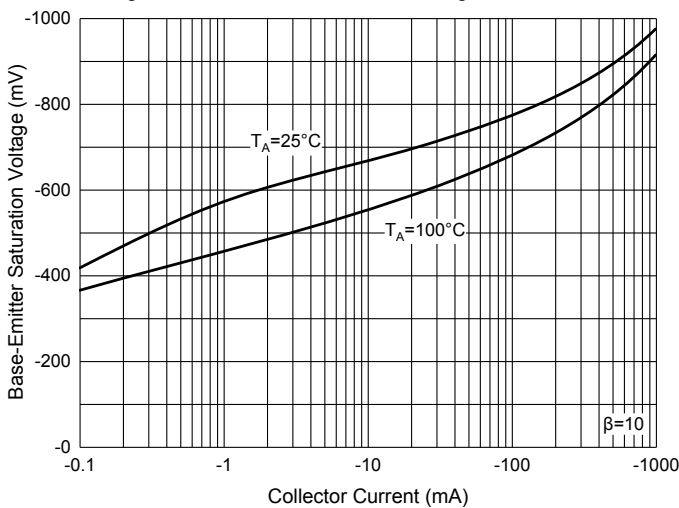

Fig. 4 - Collector-Emitter Saturation Voltage Characteristics

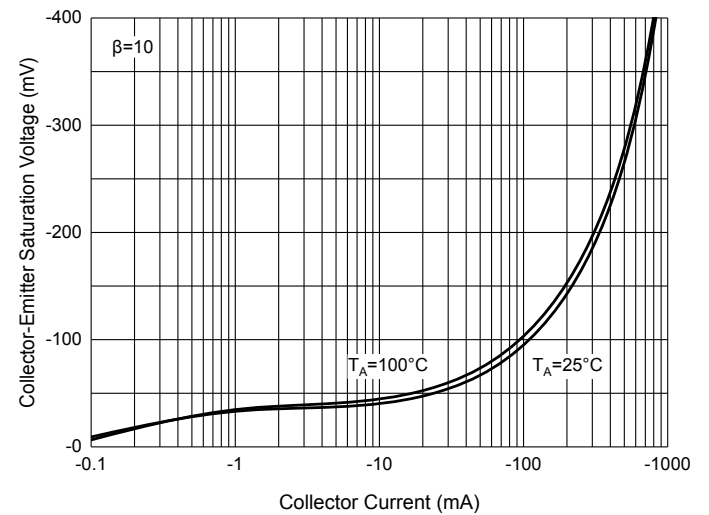

Fig. 5 - Base-Emitter Voltage Characteristics

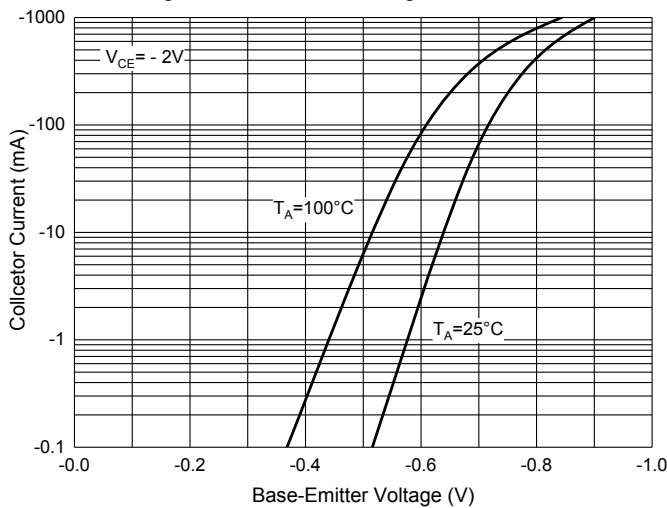
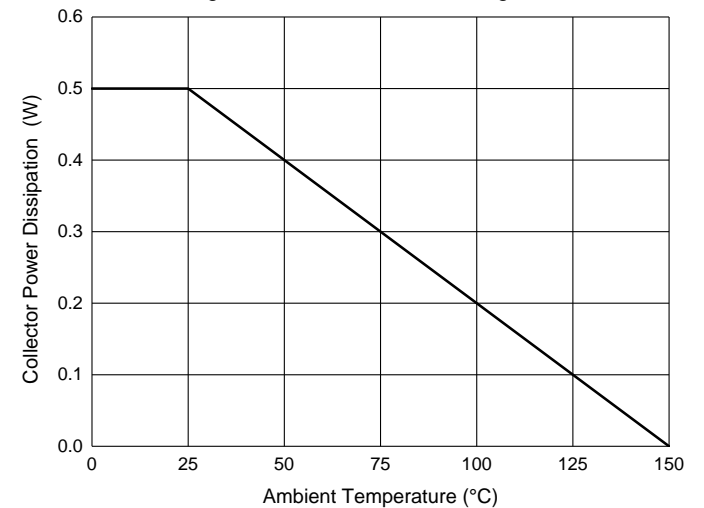

Fig. 6 - Collector Power Derating Curve



Ordering Information

| Device | Packing |
|----------------|-----------------------|
| Part Number-TP | Tape&Reel: 1Kpcs/Reel |

Note : Adding "-HF" Suffix For Halogen Free, eg. Part Number-TP-HF

IMPORTANT NOTICE

Micro Commercial Components Corp. reserves the right to make changes without further notice to any product herein to make corrections, modifications , enhancements , improvements , or other changes . **Micro Commercial Components Corp** . does not assume any liability arising out of the application or use of any product described herein; neither does it convey any license under its patent rights ,nor the rights of others . The user of products in such applications shall assume all risks of such use and will agree to hold **Micro Commercial Components Corp** . and all the companies whose products are represented on our website, harmless against all damages.

LIFE SUPPORT

MCC's products are not authorized for use as critical components in life support devices or systems without the express written approval of Micro Commercial Components Corporation.

CUSTOMER AWARENESS

Counterfeiting of semiconductor parts is a growing problem in the industry. Micro Commercial Components (MCC) is taking strong measures to protect ourselves and our customers from the proliferation of counterfeit parts. MCC strongly encourages customers to purchase MCC parts either directly from MCC or from Authorized MCC Distributors who are listed by country on our web page cited below. Products customers buy either from MCC directly or from Authorized MCC Distributors are genuine parts, have full traceability, meet MCC's quality standards for handling and storage. **MCC will not provide any warranty coverage or other assistance for parts bought from Unauthorized Sources.** MCC is committed to combat this global problem and encourage our customers to do their part in stopping this practice by buying direct or from authorized distributors.