

TLS205B0 V50

Linear Voltage Post Regulator
Low Dropout, Low Noise, 5 V, 500 mA

TLS205B0EJV50
TLS205B0LDV50

Data Sheet

Rev. 1.1, 2015-01-15



1 Overview

Features

- Low Noise down to $42 \mu V_{RMS}$ (BW = 10 Hz to 100 kHz)
- 500 mA Current Capability
- Low Quiescent Current: 30 μA
- Wide Input Voltage Range up to 20 V
- Internal circuitry working down to 2.3 V
- 2.5% Output Voltage Accuracy (over full temperature and load range)
- Low Dropout Voltage: 350 mV
- Very low Shutdown Current: < 1 μA
- No Protection Diodes needed
- Fixed Output Voltage: 5.0 V
- Stable with $\geq 3.3 \mu F$ Output Capacitor
- Stable with Aluminium, Tantalum or Ceramic Output Capacitors
- Reverse Polarity Protection
- No Reverse Current
- Overcurrent and Overtemperature Protected
- PG-DSO-8 Exposed Pad and PG-TSON-10 Exposed Pad Package
- Suitable for use in Automotive Electronics as Post Regulator
- Green Product (RoHS compliant)
- AEC Qualified

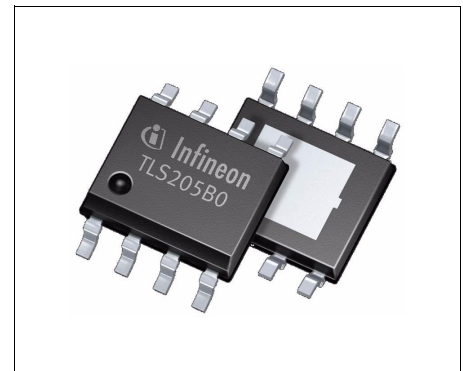

PG-DSO-8 Exposed Pad



PG-TSON-10

The TLS205B0 V50 is a micropower, low noise, low dropout voltage 5 V regulator. The device is capable of supplying an output current of 500 mA with a dropout voltage of 350 mV. Designed for use in battery-powered systems, the low quiescent current of 30 μA makes it an ideal choice.

A key feature of the TLS205B0 V50 is its low output noise. By adding an external 10 nF bypass capacitor output noise values down to $42 \mu V_{RMS}$ over a 10 Hz to 100 kHz bandwidth can be reached. The TLS205B0 V50 voltage regulator is stable with output capacitors as small as 3.3 μF . Small ceramic capacitors can be used without the series resistance required by many other linear voltage regulators.

Internal protection circuitry includes reverse battery protection, current limiting and reverse current protection. The TLS205B0 V50 comes as 5.0 V fixed output voltage variant and is available in a PG-DSO-8 Exposed Pad as well as in a PG-TSON-10 Exposed Pad package.

Type	Package	Marking
TLS205B0EJV50	PG-DSO-8 Exposed Pad	205B0V50
TLS205B0LDV50	PG-TSON-10	205B0V5

2 Block Diagram

Note: Pin numbers in block diagrams refer to the PG-DSO-8 Exposed Pad package type.

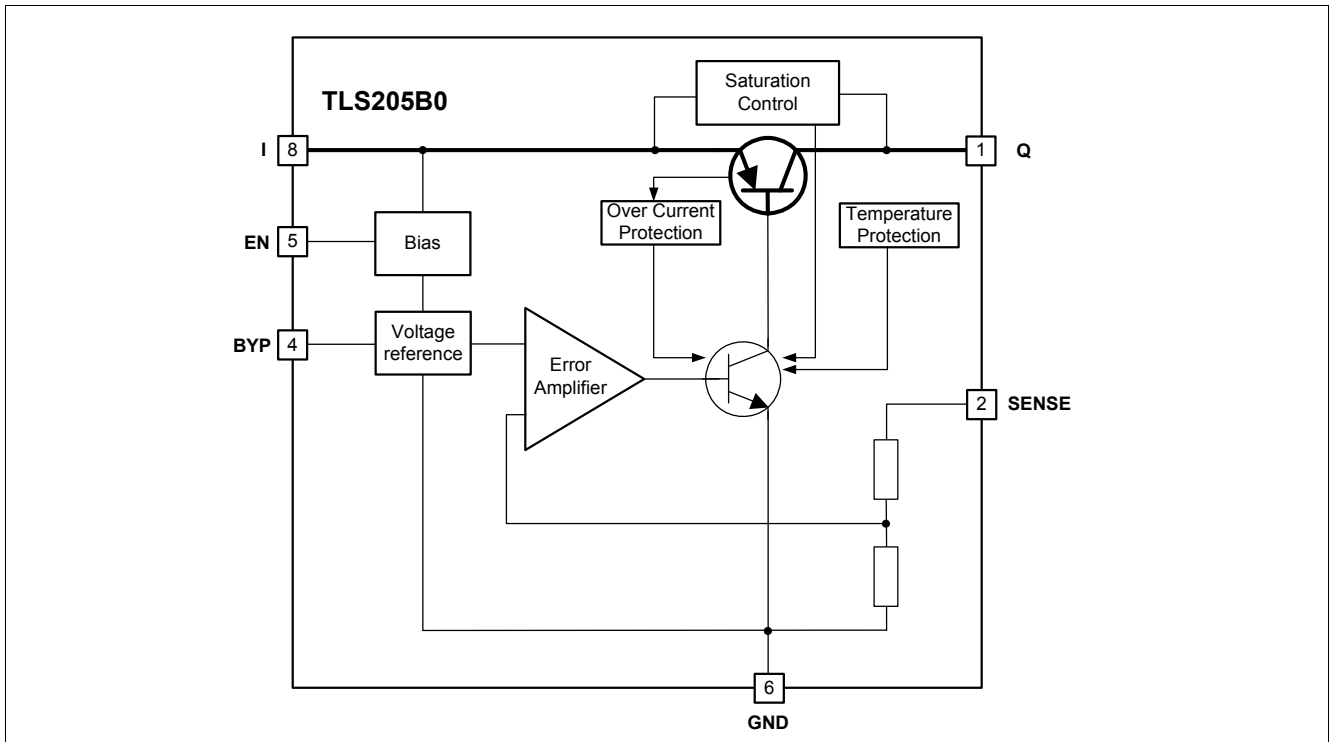

Figure 1 Block Diagram TLS205B0 V50

3 Pin Configuration

3.1 Pin Assignment

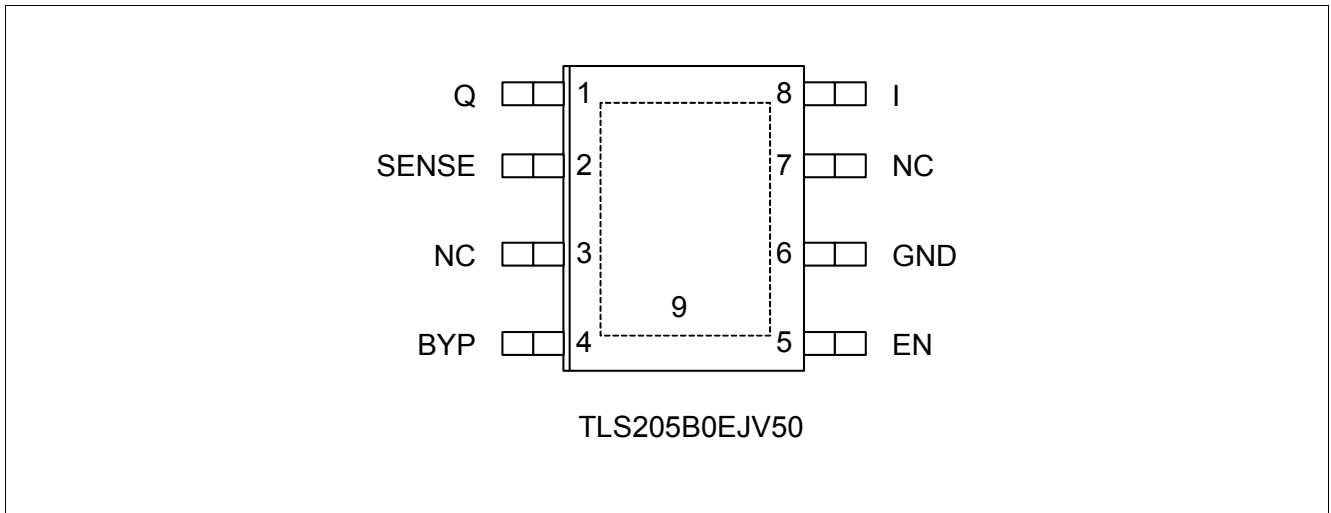

Figure 2 Pin Configuration of TLS205B0EJV50 in PG-DSO-8 Exposed Pad

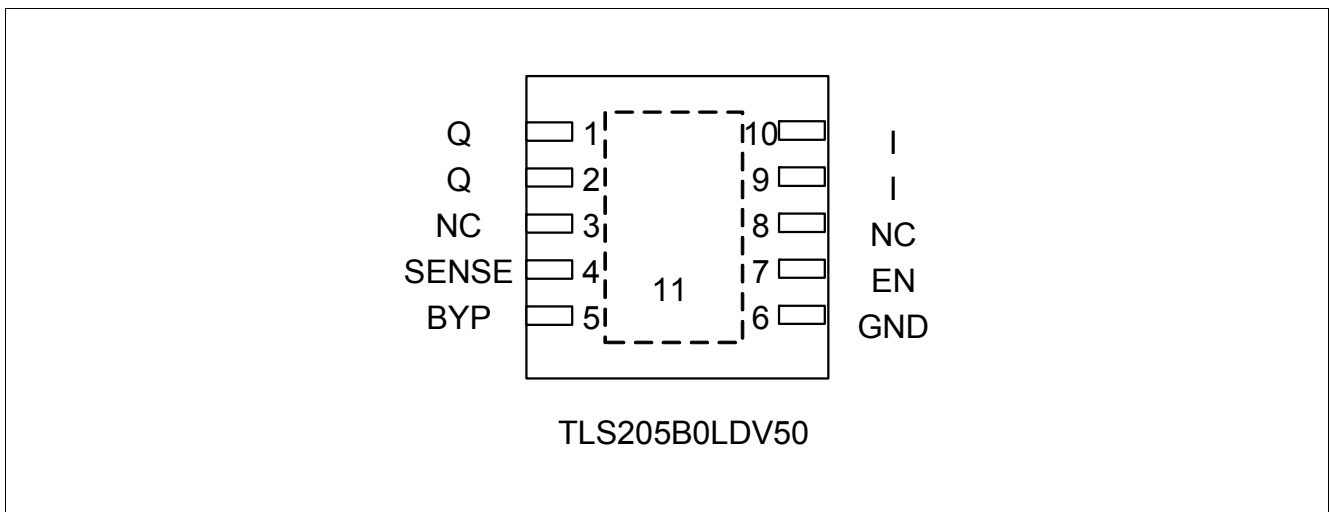

Figure 3 Pin Configuration of TLS205B0LDV50 in PG-TSON-10

3.2 Pin Definitions and Functions

Pin	Symbol	Function
1 (DSO-8 EP) 1,2 (TSON-10)	Q	Output. Supplies power to the load. For this pin a minimum output capacitor of 3.3 μ F is required to prevent oscillations. Larger output capacitors may be required for applications with large transient loads in order to limit peak voltage transients or when the regulator is applied in conjunction with a bypass capacitor. For more details please refer to “Application Information” on Page 19.
2 (DSO-8 EP) 4 (TSON-10)	SENSE	Output Sense. The SENSE pin is the input to the error amplifier. This allows to achieve an optimized regulation performance in case of small voltage drops R_p that occur between regulator and load. In applications where such drops are relevant they can be eliminated by connecting the SENSE pin directly at the load. In standard configuration the SENSE pin can be directly connected to Q. For further details please refer to the section “Kelvin Sense Connection” on Page 19.
3, 7 (DSO-8 EP) 3, 8 (TSON-10)	NC	No Connect. The NC Pins have no connection to any internal circuitry. Connect either to GND or leave open.
4 (DSO-8 EP) 5 (TSON-10)	BYP	Bypass. The BYP pin is used to bypass the reference of the TLS205B0 V50 to achieve low noise performance. The BYP-pin is clamped internally to ± 0.6 V (i.e. one V_{BE}). A small capacitor from the output Q to the BYP pin will bypass the reference to lower the output voltage noise ¹⁾ . If not used this pin must be left unconnected.
5 (DSO-8 EP) 7 (TSON-10)	EN	Enable. With the EN pin the TLS205B0 V50 can be put into a low power shutdown state. The output will be off when the EN is pulled low. The EN pin can be driven either by 3.3 V or 5 V logic or as well by open-collector logic with pull-up resistor. The pull-up resistor is required to supply the pull-up current of the open-collector gate ²⁾ and the EN pin current ³⁾ . Please note that if the EN pin is not used it must be connected to V_I . It must not be left floating.
6 (DSO-8 EP) 6,(TSON-10)	GND	Ground.
8 (DSO-8 EP) 9, 10 (TSON-10)	I	Input. The device is supplied by the input pin I. A capacitor at the input pin is required if the device is more than 6 inches away from the main input filter capacitor or if a non-negligible inductance is present at the input I ⁴⁾ . The TLS205B0 V50 is designed to withstand reverse voltages on the input pin I with respect to GND and output Q. In the case of reverse input (e.g. due to a wrongly attached battery) the device will act as if there is a diode in series with its input. In this way there will be no reverse current flowing into the regulator and no reverse voltage will appear at the load. Hence, the device will protect both - the device itself and the load.
9 (DSO-8 EP) 11 (TSON-10)	Tab	Exposed Pad. To ensure proper thermal performance, solder Pin 11 of TSON-10 to the PCB ground and tie directly to Pin 6. In the case of DSO-8 EP as well solder Pin 9 (exposed pad) to the PCB ground and tie directly to Pin 6 (GND).

- 1) A maximum value of 10 nF can be used for reducing output voltage noise over the bandwidth from 10 Hz to 100 kHz.
- 2) Normally several microamperes.
- 3) Typical value is 1 μ A.
- 4) In general the output impedance of a battery rises with frequency, so it is advisable to include a bypass capacitor in battery-powered circuits. Depending on actual conditions an input capacitor in the range of 1 to 10 μ F is sufficient.

4 General Product Characteristics

4.1 Absolute Maximum Ratings

Table 1 Absolute Maximum Ratings ¹⁾

$T_j = -40\text{ °C}$ to $+150\text{ °C}$; all voltages with respect to ground, positive current flowing into pin (unless otherwise specified)

Parameter	Symbol	Values			Unit	Note / Test Condition	Number
		Min.	Typ.	Max.			
Input Voltage							
Voltage	V_I	-20	–	20	V	–	P_4.1.1
Output Voltage							
Voltage	V_Q	-20	–	20	V	–	P_4.1.2
Input to Output Differential Voltage	$V_I - V_Q$	-20	–	20	V	–	P_4.1.3
Sense Pin							
Voltage	V_{SENSE}	-20	–	20	V	–	P_4.1.4
BYP Pin							
Voltage	V_{BYP}	-0.6	–	0.6	V		P_4.1.5
Enable Pin							
Voltage	V_{EN}	-20	–	20	V	–	P_4.1.6
Temperatures							
Junction Temperature	T_j	-40	–	150	°C	–	P_4.1.7
Storage Temperature	T_{stg}	-55	–	150	°C	–	P_4.1.8
ESD Susceptibility							
All Pins	V_{ESD}	-2	–	2	kV	HBM ²⁾	P_4.1.9
All Pins	V_{ESD}	-1	–	1	kV	CDM ³⁾	P_4.1.10

1) Not subject to production testing, specified by design.

2) ESD susceptibility, HBM according to ANSI/ESDA/JEDEC JS001 (1.5 kV, 100 pF)

3) ESD susceptibility, Charged Device Model "CDM" according JEDEC JESD22-C101

Notes

1. Stresses above the ones listed here may cause permanent damage to the device. Exposure to absolute maximum rating conditions for extended periods may affect device reliability.
2. Integrated protection functions are designed to prevent IC destruction under fault conditions described in the data sheet. Fault conditions are considered as "outside" normal operating range. Protection functions are not designed for continuous repetitive operation.

4.2 Functional Range

Table 2 Functional Range

Parameter	Symbol	Values			Unit	Note / Test Condition	Number
		Min.	Typ.	Max.			
Input Voltage Range	V_I	5.5	–	20	V	–	P_4.2.1
Output Capacitor's Requirements for Stability	C_Q	3.3	–	–	μF	$C_{\text{BYP}} = 0 \text{ nF}^{1)}$	P_4.2.2
Output Capacitor's Requirements for Stability	C_Q	6.8	–	–	μF	$0 \text{ nF} < C_{\text{BYP}} \leq 10 \text{ nF}^{1)}$	P_4.2.3
ESR	ESR	– ²⁾	–	3	Ω	– ¹⁾	P_4.2.4
Operating Junction Temperature	T_j	-40	–	125	$^{\circ}\text{C}$	–	P_4.2.5

1) for further details see corresponding graph.

2) $C_{\text{BYP}} = 0 \text{ nF}$, $C_Q \geq 3.3 \mu\text{F}$; please note that for cases where a bypass capacitor at BYP is used – depending on the actual applied capacitance of C_Q and C_{BYP} a minimum requirement for ESR of C_Q may apply.

Note: Within the functional or operating range, the IC operates as described in the circuit description. The electrical characteristics are specified within the conditions given in the Electrical Characteristics table.

4.3 Thermal Resistance

Note: This thermal data was generated in accordance with JEDEC JESD51 standards. For more information, go to www.jedec.org.

Table 3 Thermal Resistance¹⁾

Parameter	Symbol	Values			Unit	Note / Test Condition	Number
		Min.	Typ.	Max.			
TLS205B0EJV50 (PG-DSO-8 Exposed Pad)							
Junction to Case	R_{thJC}	–	7.0	–	K/W	–	P_4.3.1
Junction to Ambient	R_{thJA}	–	39	–	K/W	– ²⁾	P_4.3.2
Junction to Ambient	R_{thJA}	–	155	–	K/W	Footprint only ³⁾	P_4.3.3
Junction to Ambient	R_{thJA}	–	66	–	K/W	300 mm ² heatsink area on PCB ³⁾	P_4.3.4
Junction to Ambient	R_{thJA}	–	52	–	K/W	600 mm ² heatsink area on PCB ³⁾	P_4.3.5
TLS205B0LDV50 (PG-TSON-10)							
Junction to Case	R_{thJC}	–	6.4	–	K/W	–	P_4.3.6
Junction to Ambient	R_{thJA}	–	53	–	K/W	– ²⁾	P_4.3.7
Junction to Ambient	R_{thJA}	–	183	–	K/W	Footprint only ³⁾	P_4.3.8
Junction to Ambient	R_{thJA}	–	69	–	K/W	300 mm ² heatsink area on PCB ³⁾	P_4.3.9
Junction to Ambient	R_{thJA}	–	57	–	K/W	600 mm ² heatsink area on PCB ³⁾	P_4.3.10

1) Not subject to production test, specified by design.

General Product Characteristics

- 2) Specified R_{thJA} value is according to Jedec JESD51-2,-5,-7 at natural convection on FR4 2s2p board; The Product (Chip+Package) was simulated on a 76.2 x 114.3 x 1.5 mm board with 2 inner copper layers (2 x 70 μm Cu, 2 x 35 μm Cu). Where applicable a thermal via array under the exposed pad contacted the first inner copper layer.
- 3) Specified R_{thJA} value is according to JEDEC JESD 51-3 at natural convection on FR4 1s0p board; The Product (Chip+Package) was simulated on a 76.2 x 114.3 x 1.5 mm³ board with 1 copper layer (1 x 70 μm Cu).

5 Electrical Characteristics

Table 4 Electrical Characteristics

-40 °C < T_j < 125 °C; all voltages with respect to ground; positive current defined flowing out of pin; unless otherwise specified.

Parameter	Symbol	Values			Unit	Note / Test Condition	Number
		Min.	Typ.	Max.			
Minimum Operating Voltage ¹⁾							
Minimum Operating Voltage	$V_{I,min}$	–	1.8	2.3	V	$I_Q = 500 \text{ mA}$	P_5.0.1
Output Voltage ²⁾							
Output Voltage	V_Q	4.875	5.00	5.125	V	$1 \text{ mA} < I_Q < 500 \text{ mA}$; $6 \text{ V} < V_I < 20 \text{ V}$	P_5.0.2
Line Regulation							
Line Regulation	ΔV_Q	–	1	25	mV	$\Delta V_I = 5.5 \text{ V to } 20 \text{ V}$; $I_Q = 1 \text{ mA}$	P_5.0.3
Load Regulation							
Load Regulation	ΔV_Q	–	16	32	mV	$T_J = 25 \text{ }^\circ\text{C}$; $V_I = 6.0 \text{ V}$; $\Delta I_Q = 1 - 500 \text{ mA}$	P_5.0.4
Load Regulation	ΔV_Q	–	–	57	mV	$V_I = 6.0 \text{ V}$; $\Delta I_Q = 1 - 500 \text{ mA}$	P_5.0.5
Dropout Voltage ³⁾							
Dropout Voltage	V_{DR}	–	130	190	mV	$I_Q = 10 \text{ mA}$; $V_I = V_{Q,nom}$; $T_J = 25 \text{ }^\circ\text{C}$	P_5.0.6
Dropout Voltage	V_{DR}	–	–	250	mV	$I_Q = 10 \text{ mA}$; $V_I = V_{Q,nom}$	P_5.0.7
Dropout Voltage	V_{DR}	–	170	220	mV	$I_Q = 50 \text{ mA}$; $V_I = V_{Q,nom}$; $T_J = 25 \text{ }^\circ\text{C}$	P_5.0.8
Dropout Voltage	V_{DR}	–	–	320	mV	$I_Q = 50 \text{ mA}$; $V_I = V_{Q,nom}$	P_5.0.9
Dropout Voltage	V_{DR}	–	200	240	mV	$I_Q = 100 \text{ mA}$; $V_I = V_{Q,nom}$; $T_J = 25 \text{ }^\circ\text{C}$	P_5.0.10
Dropout Voltage	V_{DR}	–	–	340	mV	$I_Q = 100 \text{ mA}$; $V_I = V_{Q,nom}$	P_5.0.11
Dropout Voltage	V_{DR}	–	350	380	mV	$I_Q = 500 \text{ mA}$; $V_I = V_{Q,nom}$; $T_J = 25 \text{ }^\circ\text{C}$	P_5.0.12
Dropout Voltage	V_{DR}	–	–	480	mV	$I_Q = 500 \text{ mA}$; $V_I = V_{Q,nom}$	P_5.0.13
Quiescent Current							
Quiescent Current (Active-Mode, EN-pin high)	I_q	–	30	60	μA	$V_I = V_{Q,nom}$; $I_Q = 0 \text{ mA}$	P_5.0.14
Quiescent Current (Off-Mode, EN-pin low)	I_q	–	0.1	1	μA	$V_I = 6 \text{ V}$; $V_{EN} = 0 \text{ V}$; $T_J = 25 \text{ }^\circ\text{C}$	P_5.0.15
GND Pin Current ⁴⁾							
GND Pin Current	I_{GND}	–	50	100	μA	$V_I = V_{Q,nom}$; $I_Q = 1 \text{ mA}$	P_5.0.16

Table 4 Electrical Characteristics (cont'd)

-40 °C < T_J < 125 °C; all voltages with respect to ground; positive current defined flowing out of pin; unless otherwise specified.

Parameter	Symbol	Values			Unit	Note / Test Condition	Number
		Min.	Typ.	Max.			
GND Pin Current	I_{GND}	–	300	850	μA	$V_I = V_{Q,nom}$; $I_Q = 50$ mA	P_5.0.17
GND Pin Current	I_{GND}	–	0.7	2.2	mA	$V_I = V_{Q,nom}$; $I_Q = 100$ mA	P_5.0.18
GND Pin Current	I_{GND}	–	3	8	mA	$V_I = V_{Q,nom}$; $I_Q = 250$ mA	P_5.0.19
GND Pin Current	I_{GND}	–	11	22	mA	$V_I = V_{Q,nom}$; $I_Q = 500$ mA ; $T_J \geq 25$ °C	P_5.0.20
GND Pin Current	I_{GND}	–	11	31	mA	$V_I = V_{Q,nom}$; $I_Q = 500$ mA ; $T_J < 25$ °C	P_5.0.21
Enable							
Enable Threshold High	$V_{th,EN}$	–	0.8	2.0	V	$V_Q =$ Off to On	P_5.0.22
Enable Threshold Low	$V_{th,EN}$	0.25	0.65	–	V	$V_Q =$ On to Off	P_5.0.23
EN Pin Current ⁵⁾	I_{EN}	–	0.01	–	μA	$V_{EN} = 0$ V ; $T_J = 25$ °C	P_5.0.24
EN Pin Current ⁵⁾	I_{EN}	–	1	–	μA	$V_{EN} = 20$ V ; $T_J = 25$ °C	P_5.0.25
Output Voltage Noise ⁶⁾							
Output Voltage Noise	e_{no}	–	55	–	μV_{RMS}	$C_Q = 10$ μF ; $C_{BYP} = 10$ nF ; $I_Q = 500$ mA ; BW = 10 Hz to 100 kHz	P_5.0.26
Output Voltage Noise	e_{no}	–	44	–	μV_{RMS}	$C_Q = 10$ μF +250mΩ resistor in series; $C_{BYP} = 10$ nF ; $I_Q = 500$ mA ; BW = 10 Hz to 100 kHz	P_5.0.27
Output Voltage Noise	e_{no}	–	42	–	μV_{RMS}	$C_Q = 22$ μF $C_{BYP} = 10$ nF ; $I_Q = 500$ mA ; BW = 10 Hz to 100 kHz	P_5.0.28
Output Voltage Noise	e_{no}	–	42	–	μV_{RMS}	$C_Q = 22$ μF +250mΩ resistor in series; $C_{BYP} = 10$ nF ; $I_Q = 500$ mA ; BW = 10 Hz to 100 kHz	P_5.0.29
Power Supply Ripple Rejection ⁶⁾							
Power Supply Ripple Rejection	$PSRR$	–	65	–	dB	$V_I - V_Q = 1.5$ V (avg) ; $V_{RIPPLE} = 0.5$ Vpp ; $f_r = 120$ Hz ; $I_Q = 500$ mA	P_5.0.30
Output Current Limitation							
Output Current Limit	$I_{Q,limit}$	520	–	–	mA	$V_I = 7$ V ; $V_Q = 0$ V	P_5.0.31

Table 4 Electrical Characteristics (cont'd)

-40 °C < T_j < 125 °C; all voltages with respect to ground; positive current defined flowing out of pin; unless otherwise specified.

Parameter	Symbol	Values			Unit	Note / Test Condition	Number
		Min.	Typ.	Max.			
Output Current Limit	$I_{Q,limit}$	520	–	–	mA	$V_I = V_{Q,nom} + 1 \text{ V};$ $\Delta V_Q = -0.1 \text{ V}$	P_5.0.32
Input Reverse Leakage Current							
Input Reverse Leakage	$I_{leak,rev}$	–	–	1	mA	$V_I = -20 \text{ V}; V_Q = 0 \text{ V}$	P_5.0.33
Reverse Output Current ⁷⁾							
Reverse Output Current	$I_{Reverse}$	–	10	20	µA	$V_Q = V_{Q,nom}; V_I < V_{Q,nom};$ $T_J = 25 \text{ °C}$	P_5.0.34

- 1) This parameter defines the minimum input voltage for which the device is powered up and provides the maximum nominal output current of 500 mA. Under this minimum input voltage condition the TLS205B0 V50 starts to be in tracking mode and the output voltage will typically be in the range of around 1 V while providing the 500 mA.
- 2) The operation conditions are limited by the maximum junction temperature. The regulated output voltage specification will only apply for conditions where the limit of the maximum junction temperature is fulfilled. It will therefore not apply for all possible combinations of input voltage and output current. When operating at maximum input voltage, the output current must be limited for thermal reasons. The same holds true when operating at maximum output current where the input voltage range must be limited for thermal reasons.
- 3) The dropout voltage is the minimum input to output voltage differential needed to maintain regulation at a specified output current. In dropout, the output voltage will be equal to $V_I - V_{DR}$.
- 4) GND-pin current is tested with $V_I = V_{Q,nom}$ and a current source load. This means that this parameter is tested while being in the dropout region. The GND pin current will in most cases decrease slightly at higher input voltages - please also refer to the corresponding typical performance graphs.
- 5) The EN pin current flows into EN pin.
- 6) Not subject to production test, specified by design.
- 7) Reverse output current is tested with the I pin grounded and the Q pin forced to the rated output voltage. This current flows into the Q pin and out of the GND pin.

Note: The listed characteristics are ensured over the operating range of the integrated circuit. Typical characteristics specified mean values expected over the production spread. If not otherwise specified, typical characteristics apply at $T_A = 25 \text{ °C}$ and the given supply voltage.

5.1 Typical Performance Characteristics

Dropout Voltage V_{DR} versus Output Current I_Q

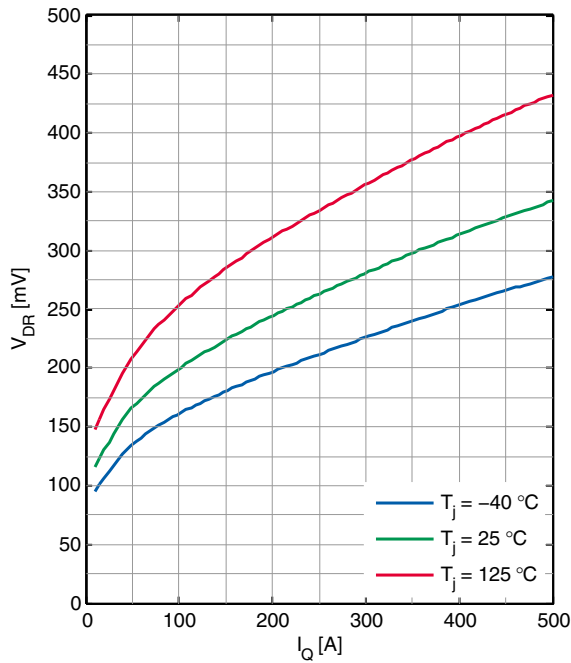

Guaranteed Dropout Voltage V_{DR} versus Output Current I_Q

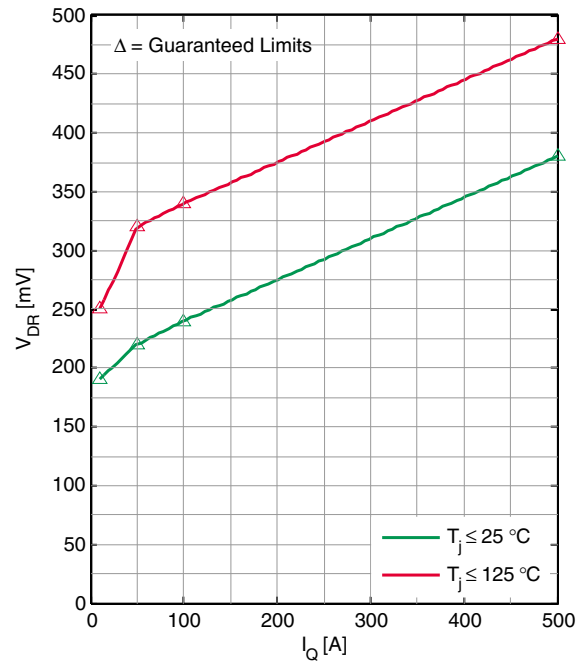

Dropout Voltage V_{DR} versus Junction Temperature T_j

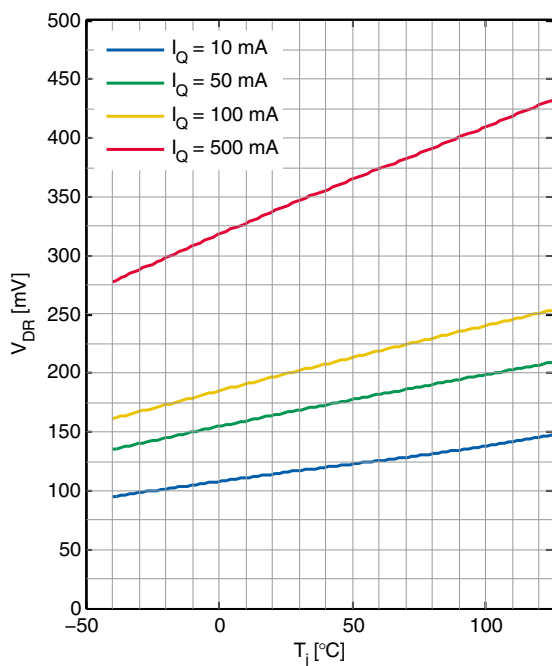

Quiescent Current versus Junction Temperature T_j

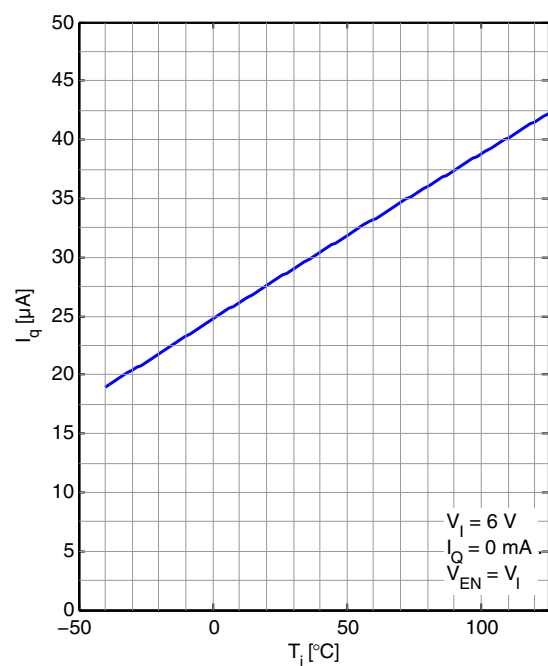

Output Voltage V_Q versus
 Junction Temperature T_J

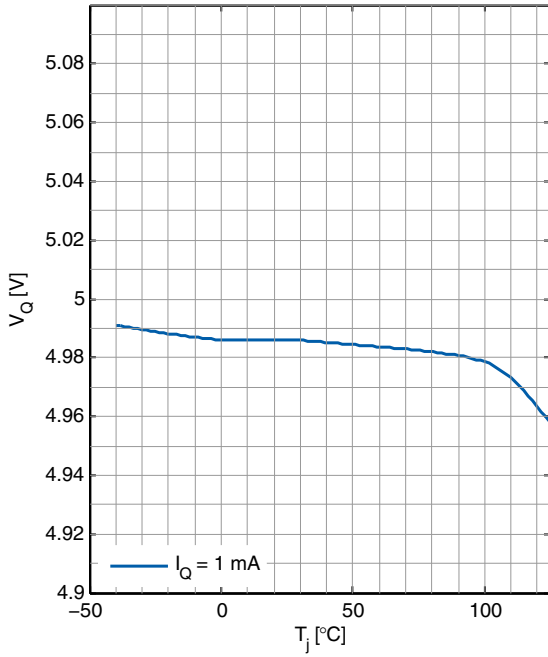

Quiescent Current I_Q versus
 Input Voltage V_I

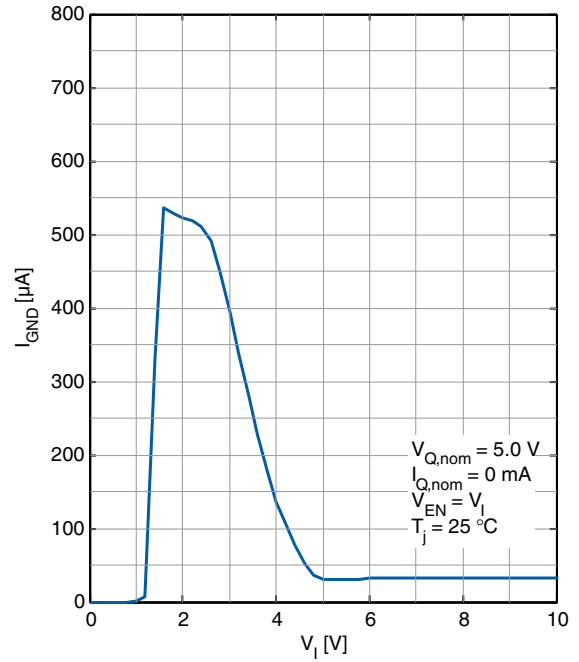

GND Pin Current I_{GND} versus
 Input Voltage V_I

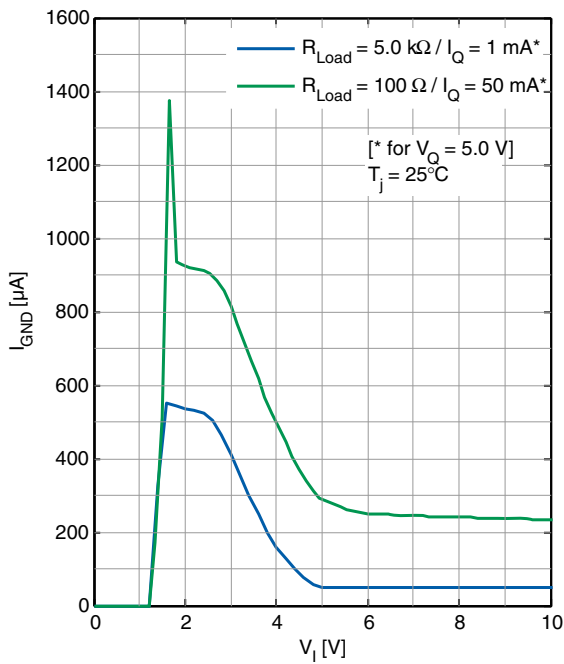

GND Pin Current I_{GND} versus
 Input Voltage V_I

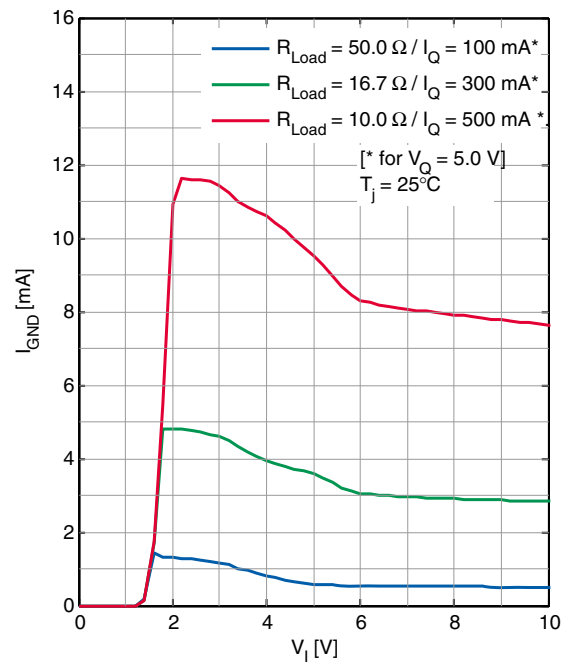

GND Pin Current I_{GND} versus Output Current I_Q

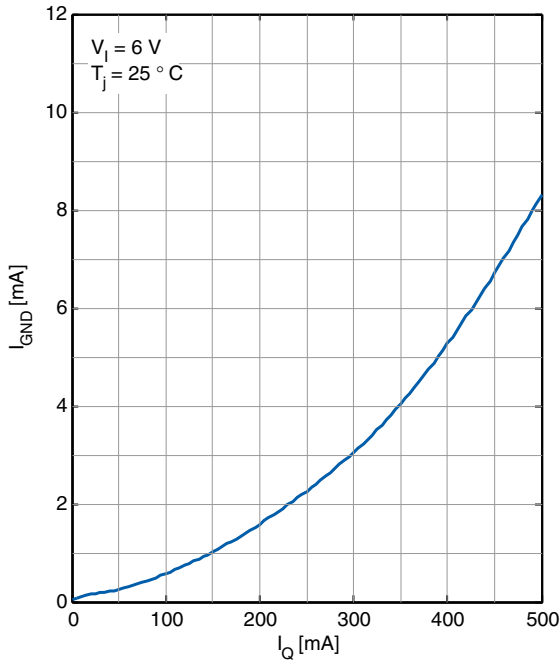

EN Pin Threshold (On-to-Off) versus Junction Temperature T_J

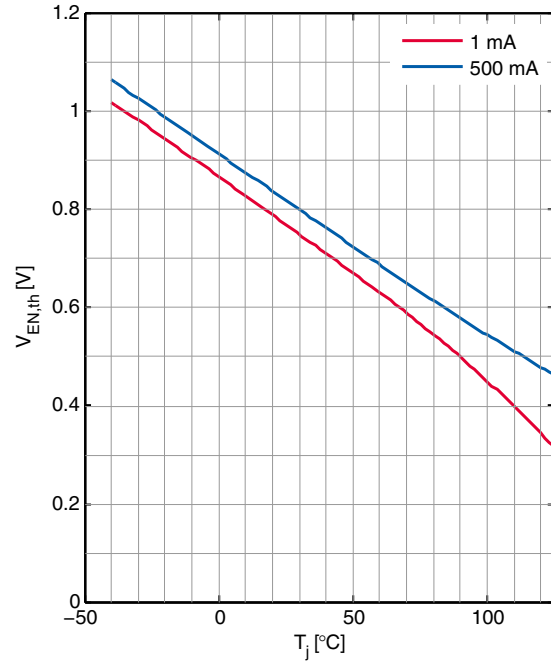

EN Pin Threshold (Off-to-On) versus Junction Temperature T_J

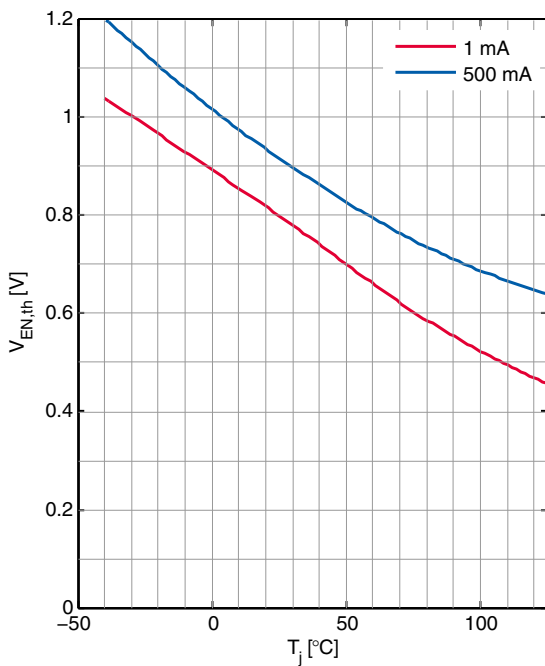

EN Pin Input Current versus EN Pin Voltage V_{EN}

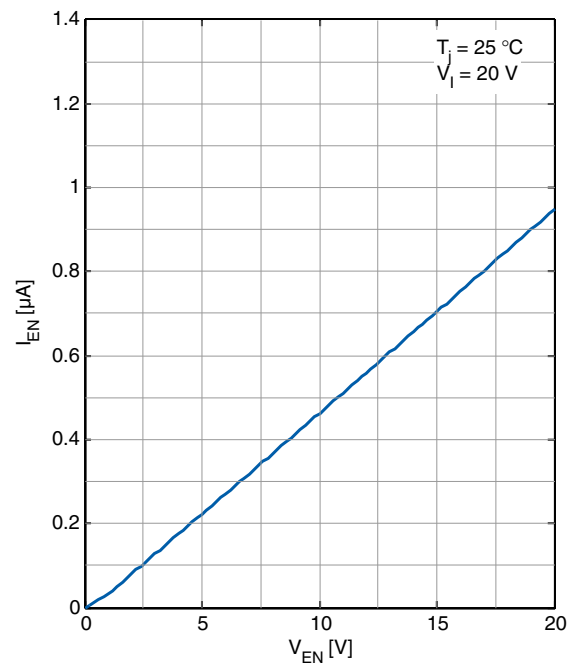

EN Pin Current versus
 Junction Temperature T_j

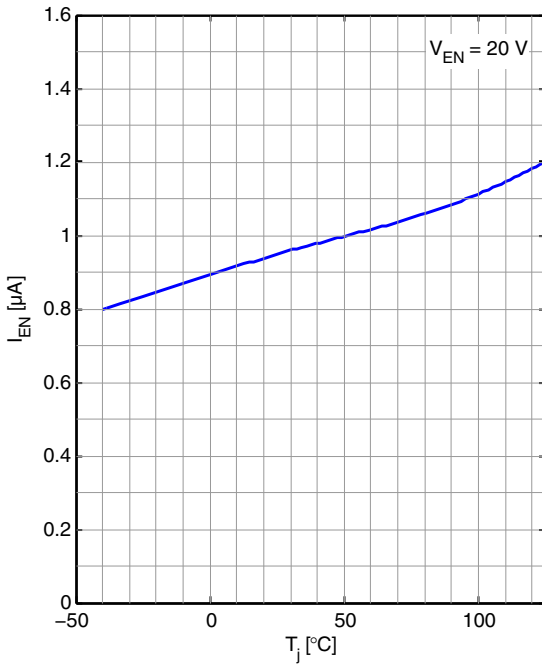

Current Limit versus
 Input Voltage V_I

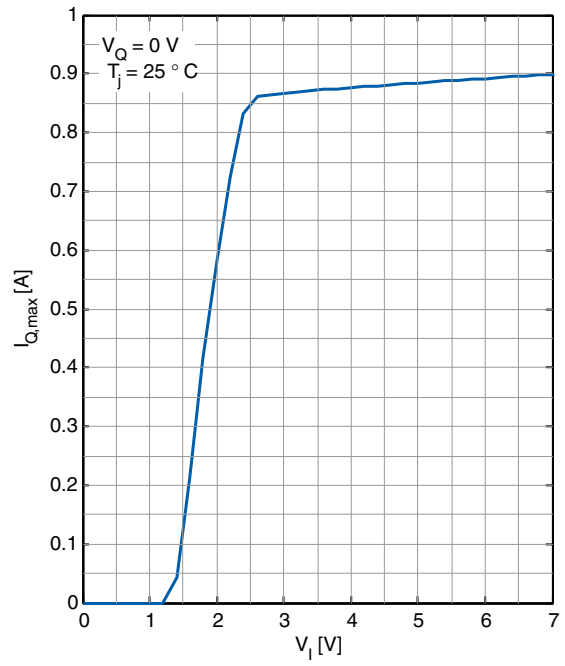

Current Limit versus
 Junction Temperature T_j

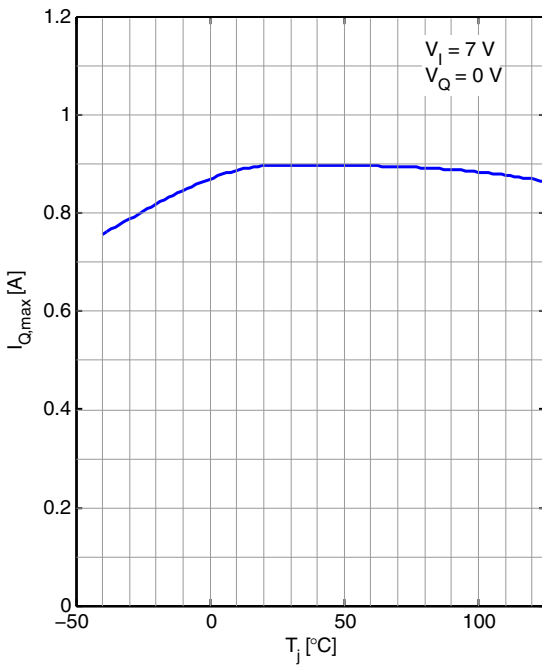

Reverse Output Current versus
 Output Voltage V_Q

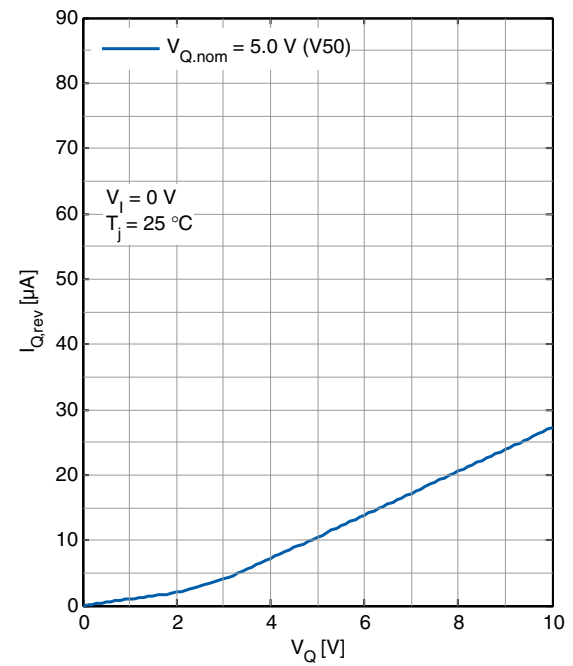

Reverse Output Current versus
 Junction Temperature T_J

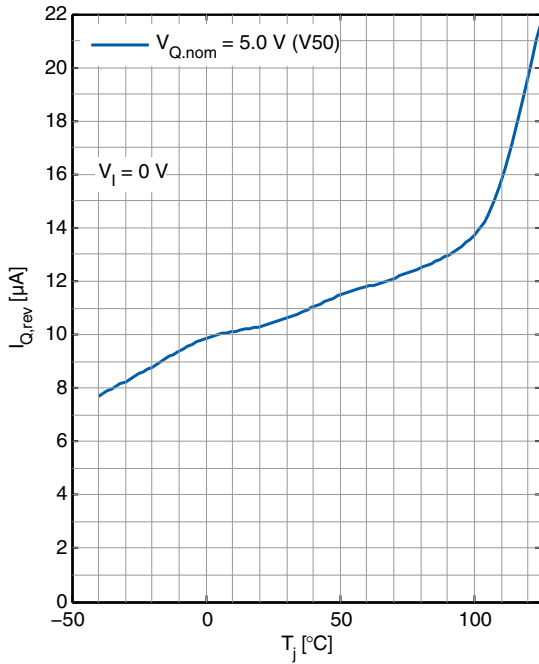

Minimum Input Voltage ¹⁾ versus
 Junction Temperature T_J

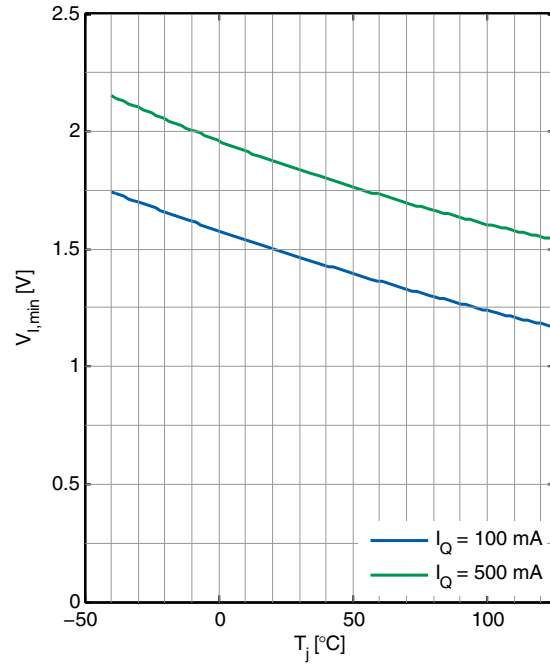

Load Regulation versus
 Junction Temperature T_J

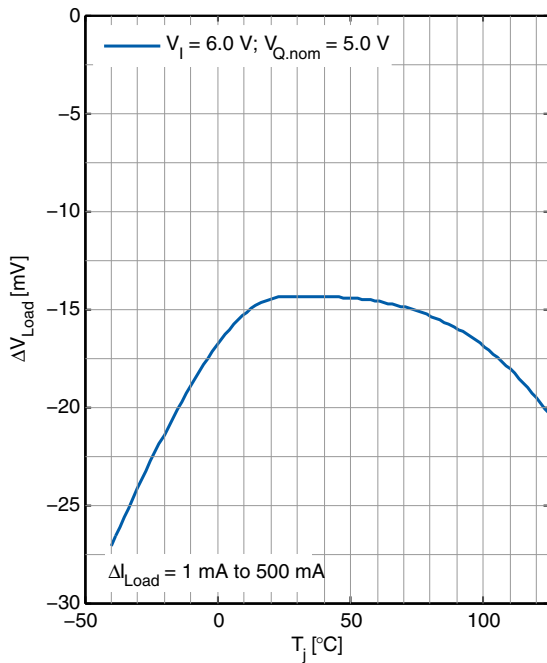

1) $V_{I,min}$ is referred here as the minimum input voltage for which the requested current is provided and V_Q reaches 1 V.

ESR Stability versus
 Output Current I_Q (for $C_Q = 3.3 \mu\text{F}$)

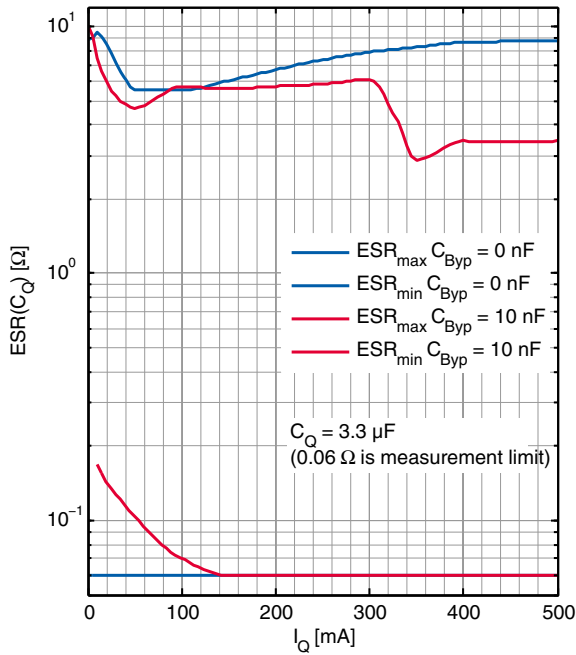

ESR(C_Q) with $C_{BYP} = 10 \text{ nF}$ versus
 Output Capacitance C_Q

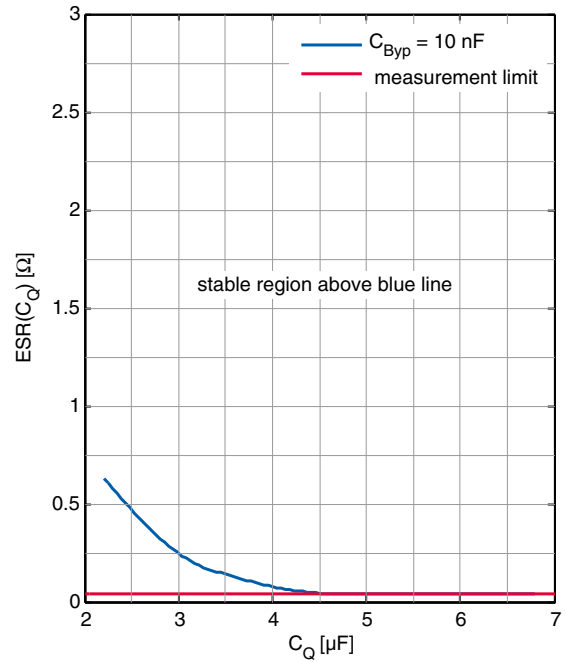

Input Ripple Rejection PSRR versus
 Frequency f

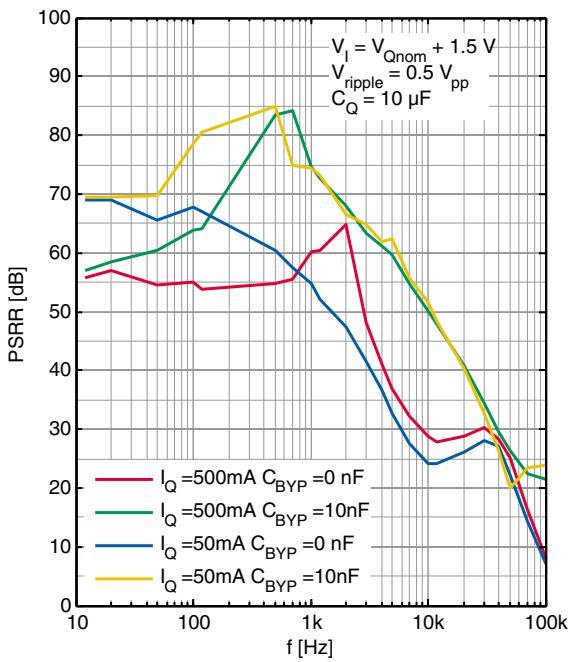

Input Ripple Rejection PSRR versus
 Junction Temperature T_J

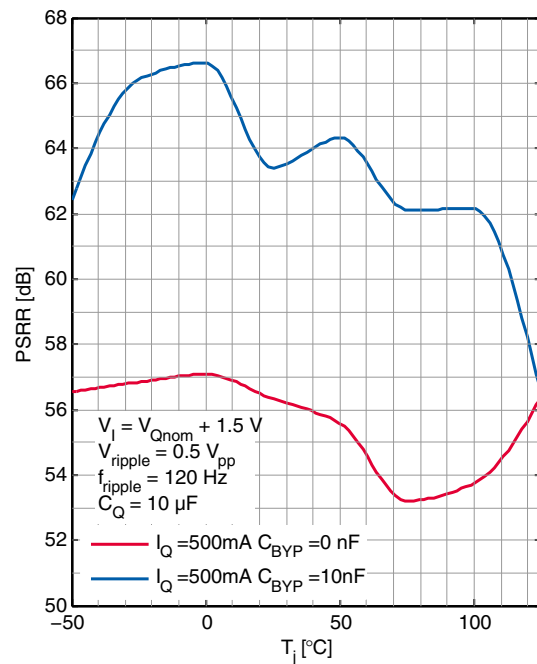

Output Noise Spectral Density versus Frequency f ($C_Q = 10 \mu\text{F}$, $I_Q = 50 \text{ mA}$)

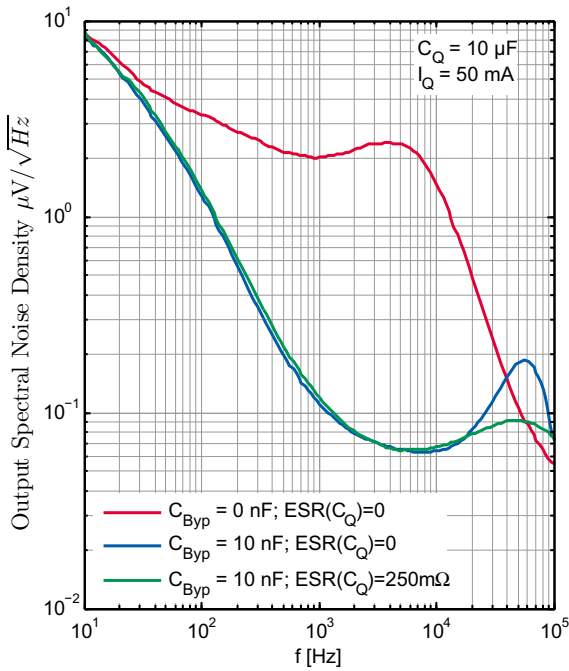

Output Noise Spectral Density versus Frequency f ($C_Q = 22 \mu\text{F}$, $I_Q = 50 \text{ mA}$)

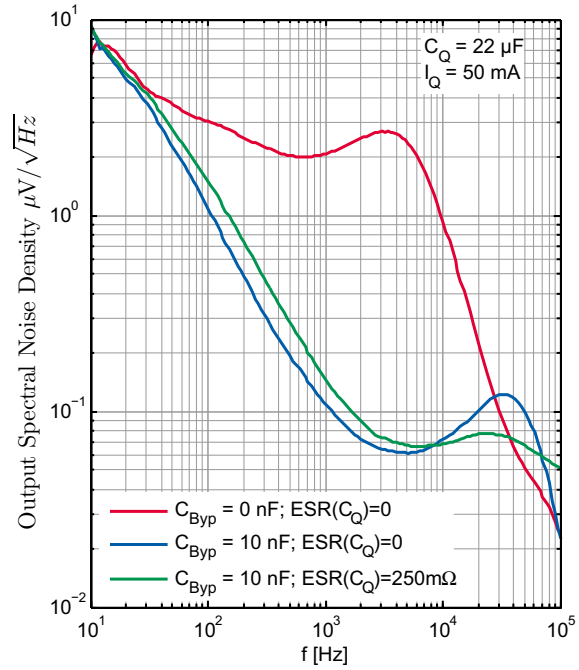

Transient Response $C_{BYP} = 0 \text{ nF}$

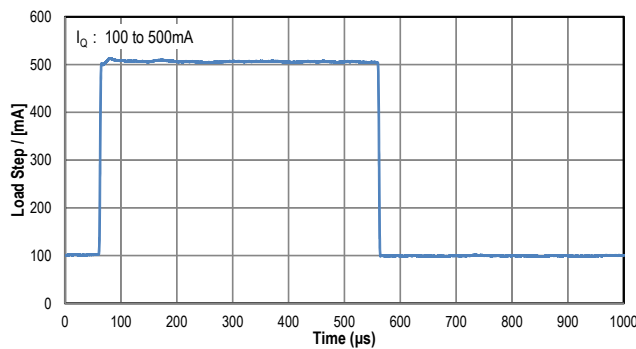
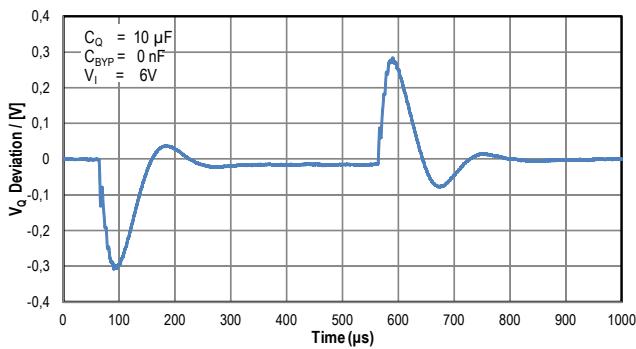

Transient Response $C_{BYP} = 10 \text{ nF}$

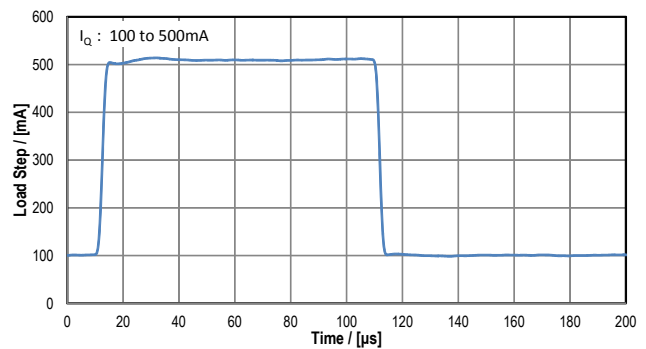
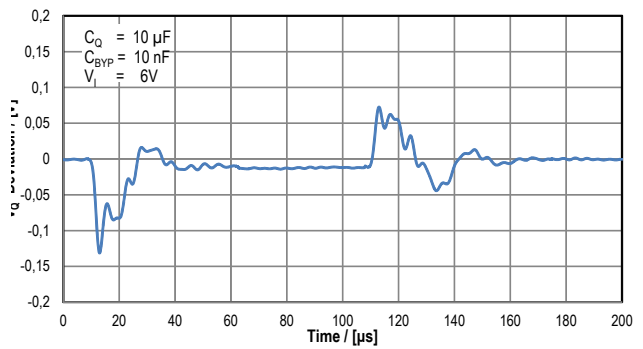

6 Application Information

Note: The following information is given as a hint for the implementation of the device only and shall not be regarded as a description or warranty of a certain functionality, condition or quality of the device.

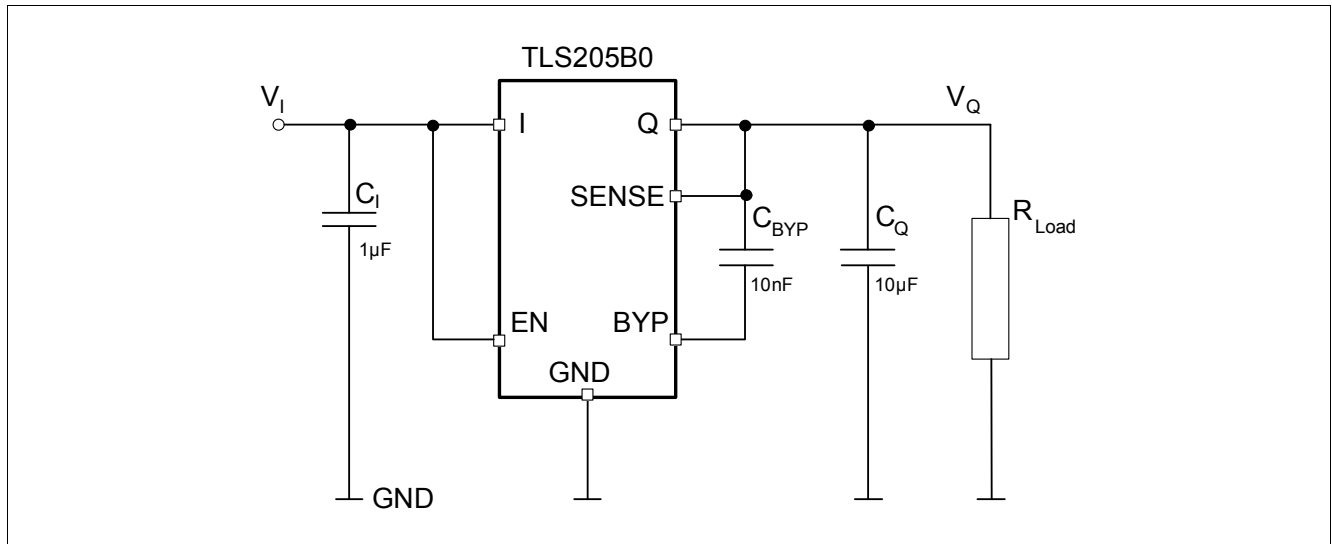

Figure 4 Typical Application Circuit TLS205B0 V50

Note: This is a very simplified example of an application circuit. The function must be verified in the real application. ^{1) 2)}

The TLS205B0 V50 is a 500 mA low dropout regulator with very low quiescent current and Enable-functionality. The device is capable of supplying 500 mA at a dropout voltage of 350 mV. Output voltage noise numbers down to $42 \mu V_{RMS}$ can be achieved over a 10 Hz to 100 kHz bandwidth with the addition of a 10 nF reference bypass capacitor. The usage of a reference bypass capacitor will additionally improve transient response of the regulator, lowering the settling time for transient load conditions. The device has a low operating quiescent current of typical 30 μA that drops to less than 1 μA in shutdown (EN-pin pulled to low level). The device also incorporates several protection features which makes it ideal for battery-powered systems. It is protected against both reverse input and reverse output voltages.

6.1 Kelvin Sense Connection

The SENSE pin of the TLS205B0 V50 is the input to the error amplifier. An optimum regulation will be obtained at the point where the SENSE pin is connected to the output pin Q of the regulator. In critical applications however small voltage drops may be caused by the resistance R_p of the PC-traces and thus may lower the resulting voltage at the load. This effect may be eliminated by connecting the SENSE pin to the output as close as possible at the load (see [Figure 5](#)). Please note that the voltage drop across the external PC trace will add up to the dropout voltage of the regulator.

- 1) Please note that in case a non-negligible inductance at the input pin I is present, e.g. due to long cables, traces, parasitics, etc, a bigger input capacitor C_I may be required to filter its influence. As a rule of thumb if the I pin is more than six inches away from the main input filter capacitor an input capacitor value of $C_I = 10 \mu F$ is recommended.
- 2) For specific needs a small optional resistor may be placed in series to very low ESR output capacitors C_Q for enhanced noise performance (for details please see ["Bypass Capacitance and Low Noise Performance"](#) on [Page 20](#)).

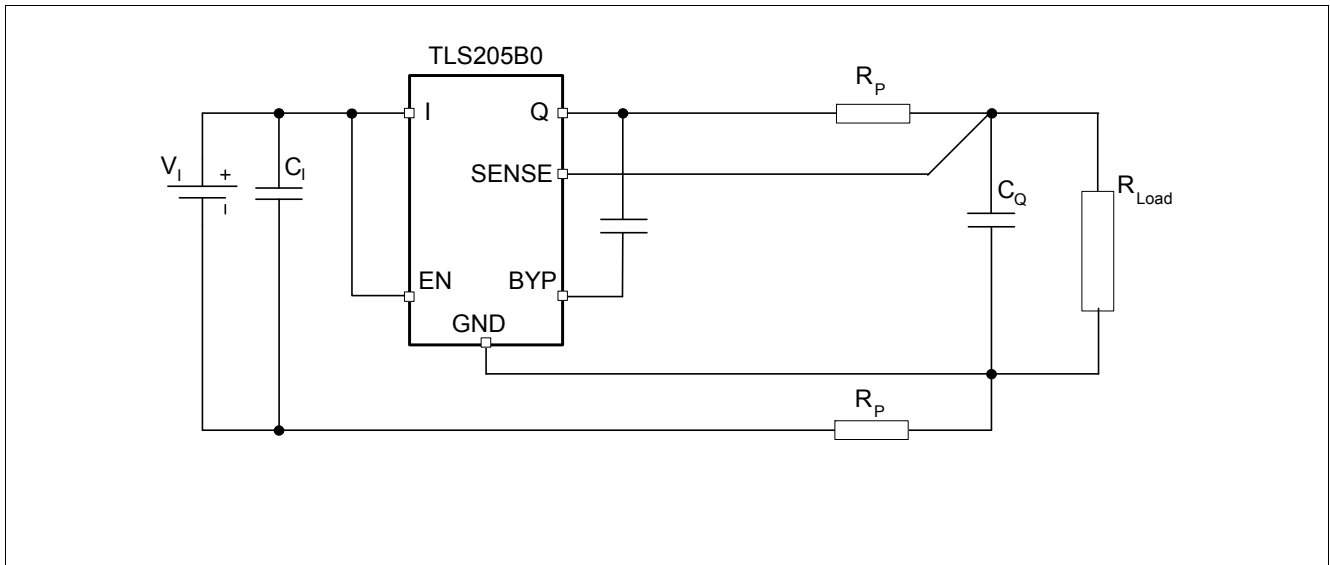

Figure 5 Kelvin Sense Connection

6.2 Bypass Capacitance and Low Noise Performance

The TLS205B0 V50 regulator may be used in combination with a bypass capacitor connecting the output pin Q to the BYP pin in order to minimize output voltage noise ¹⁾. This capacitor will bypass the reference of the regulator, providing a low frequency noise pole. The noise pole provided by such a bypass capacitor will lower the output voltage noise in the considered bandwidth. Actual numbers of the output voltage noise of the TLS205B0 V50 will - next to the bypass capacitor itself - be dependent on the capacitance of the applied output capacitor C_Q and its ESR: In case of applying a bypass capacitor of 10 nF in combination with a (low ESR) ceramic C_Q of 10 μ F output voltage noise numbers will be in the range of typical $55 \mu V_{RMS}$. This output noise level can be reduced to typical $44 \mu V_{RMS}$ under the same conditions by adding a small resistor of ~ 250 m Ω in series to the 10 μ F ceramic output capacitor acting as additional ESR. A reduction of the output voltage noise can also be achieved by increasing capacitance of the output capacitor. For $C_Q = 22 \mu$ F (ceramic low ESR) the output voltage noise will be typically around $42 \mu V_{RMS}$. For output capacitor values of 22 μ F or bigger adding resistance in series to C_Q does not further lower output noise numbers significantly anymore. For further details please also see **“Output Voltage Noise” on Page 10**, of the Electrical Characteristics. Please note that next to reducing the output voltage noise level the usage of a bypass capacitor has the additional benefit of improving transient response which will be also explained in the next chapter. However one needs to take into consideration that on the other hand the regulator start-up time is proportional to the size of the bypass capacitor and slows down to values around 15 ms when using a 10 nF bypass capacitor in combination with a 10 μ F C_Q output capacitor.

6.3 Output Capacitance and Transient Response

The TLS205B0 V50 is designed to be stable with a wide range of output capacitors. The ESR of the output capacitor is an essential parameter with regard to stability, most notably with small capacitors. A minimum output capacitor of 3.3 μ F with an ESR of 3 Ω or less is recommended to prevent oscillations. Like in general for LDO's the output transient response of the TLS205B0 V50 will be a function of the output capacitance. Larger values of output capacitance decrease peak deviations and thus improve transient response for larger load current changes. Bypass capacitors, used to decouple individual components powered by the TLS205B0 V50 will increase the effective output capacitor value. Please note that with the usage of bypass capacitors for low noise operation either larger values of output capacitors may be needed or a minimum ESR requirement of C_Q may have to be considered (see also typical performance graph **“ESR(CQ) with CBYP = 10 nF versus Output**

1) a good quality low leakage capacitor is recommended.

Capacitance C_Q " on Page 17 as example). In conjunction with the usage of a 10 nF bypass capacitor an output capacitor $C_Q \geq 6.8 \mu\text{F}$ is recommended. The benefit of a bypass capacitor to the transient response performance is impressive and illustrated as one example in Figure 6 where the transient response of the TLS205B0 V50 to one and the same load step from 100 mA to 500 mA is shown with and without a 10 nF bypass capacitor: for the given configuration of $C_Q = 10 \mu\text{F}$ with no bypass capacitor the load step will settle in the range of less than 200 μs while for $C_Q = 10 \mu\text{F}$ in conjunction with a 10 nF bypass capacitor the same load step will settle in the range of 20 μs . Due to the shorter reaction time of the regulator by adding the bypass capacitor not only the settling time improves but also output voltage deviations due to load steps are sharply reduced.

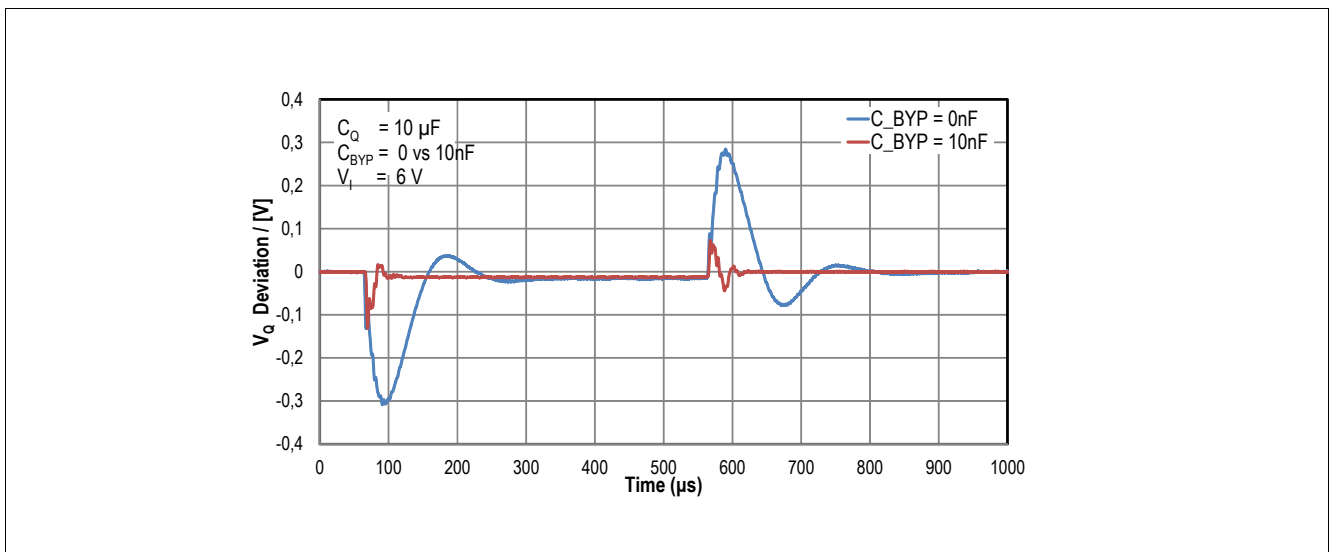

Figure 6 Influence of C_{BYP} : example of transient response to one and the same load step with and without C_{BYP} of 10 nF (I_Q : 100 mA to 500 mA)

6.4 Protection Features

The TLS205B0 V50 regulators incorporate several protection features which make them ideal for use in battery-powered circuits. In addition to normal protection features associated with monolithic regulators like current limiting and thermal limiting the device is protected against reverse input voltage, reverse output voltage and reverse voltages from output to input.

Current limit protection and thermal overload protection are intended to protect the device against current overload conditions at the output of the device. For normal operation the junction temperature must not exceed 125 °C.

The input of the device will withstand reverse voltages of 20 V. Current flowing into the device will be limited to less than 1 mA (typically less than 100 μA) and no negative voltage will appear at the output. The device will protect both itself and the load. This provides protection against batteries being plugged backwards.

The output of the TLS205B0 V50 can be pulled below ground without damaging the device. If the input is left open-circuit or grounded, the output can be pulled below ground by 20 V. Under such conditions the output of the device by itself behaves like an open circuit with practically no current flowing out of the pin ¹⁾. In more application relevant cases however where the output is connected to the SENSE pin there will be a small current of typically less than 100 μA present from this origin. If the input is powered by a voltage source the output will source the short circuit current of the device and will protect itself by thermal limiting. In this case grounding the EN pin will turn off the device and stop the output from sourcing the short-circuit current.

In circuits where a backup battery is required, several different input/output conditions can occur. The output voltage may be held up while the input is either pulled to ground, pulled to some intermediate voltage or is left open-circuit. Current flow back into the output will follow the curve as shown in Figure 7 below.

1) typically < 1 μA for the mentioned conditions, V_Q being pulled below ground with other pins either grounded or open.

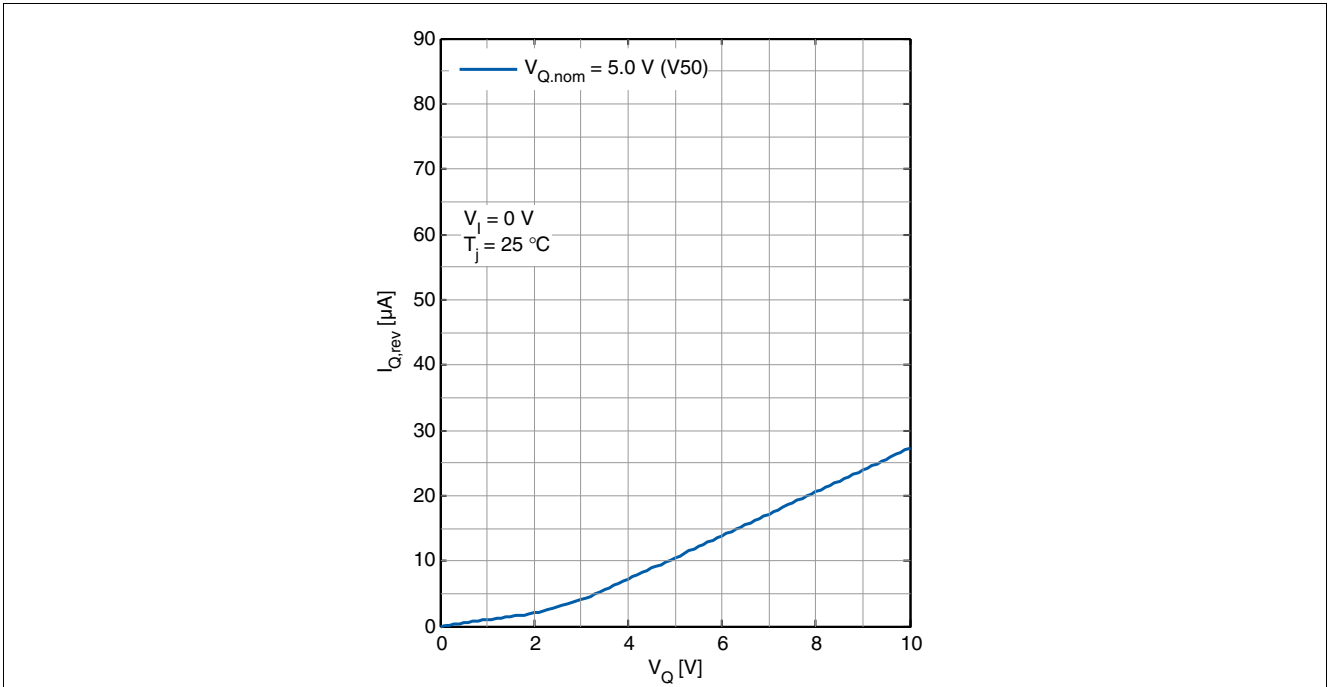

Figure 7 Reverse Output Current

7 Package Outlines

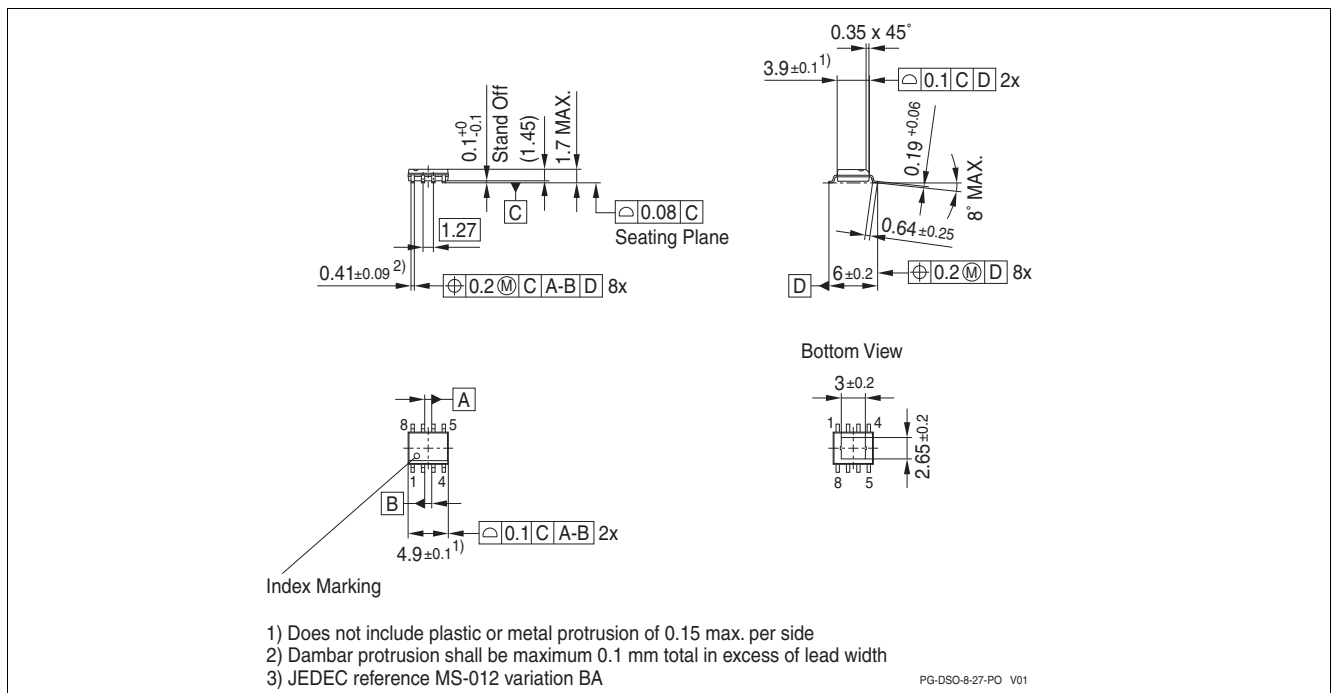

Figure 8 PG-DSO-8 Exposed Pad package outlines

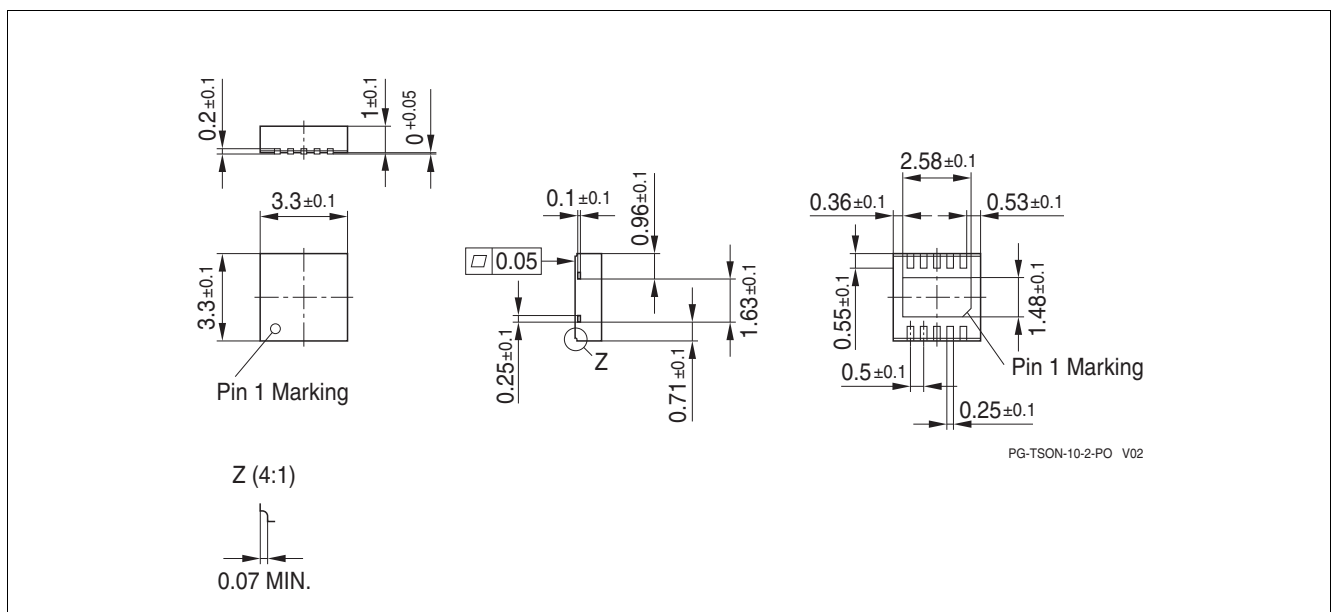

Figure 9 PG-TSON-10 Package Outlines

Green Product (RoHS compliant)

To meet the world-wide customer requirements for environmentally friendly products and to be compliant with government regulations the device is available as a green product. Green products are RoHS-Compliant (i.e. Pb-free finish on leads and suitable for Pb-free soldering according to IPC/JEDEC J-STD-020).

For further information on alternative packages, please visit our website:

<http://www.infineon.com/packages>.

Dimensions in mm

8 Revision History

Revision	Date	Changes
1.1	2015-01-15	Data Sheet - Revision 1.1: <ul style="list-style-type: none">• PG-TSON-10 package variant added: Product Overview, Pin Configuration, Thermal Resistance, etc - wording and description added / updated accordingly.• Editorial changes.
1.0	2014-06-30	Data Sheet - Initial Release

Edition 2015-01-15

**Published by
Infineon Technologies AG
81726 Munich, Germany**

**© 2015 Infineon Technologies AG
All Rights Reserved.**

Legal Disclaimer

The information given in this document shall in no event be regarded as a guarantee of conditions or characteristics. With respect to any examples or hints given herein, any typical values stated herein and/or any information regarding the application of the device, Infineon Technologies hereby disclaims any and all warranties and liabilities of any kind, including without limitation, warranties of non-infringement of intellectual property rights of any third party.

Information

For further information on technology, delivery terms and conditions and prices, please contact the nearest Infineon Technologies Office (www.infineon.com).

Warnings

Due to technical requirements, components may contain dangerous substances. For information on the types in question, please contact the nearest Infineon Technologies Office.

Infineon Technologies components may be used in life-support devices or systems only with the express written approval of Infineon Technologies, if a failure of such components can reasonably be expected to cause the failure of that life-support device or system or to affect the safety or effectiveness of that device or system. Life support devices or systems are intended to be implanted in the human body or to support and/or maintain and sustain and/or protect human life. If they fail, it is reasonable to assume that the health of the user or other persons may be endangered.