

# TLE94004EP

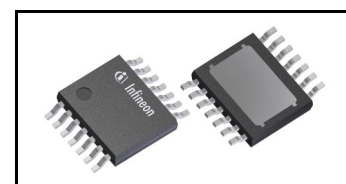

## Features

- Four half bridge power outputs
- Very low power consumption in sleep mode
- 3.3V / 5V compatible inputs with hysteresis
- All outputs with overload and short circuit protection
- Direct interface for control and diagnosis
- Overtemperature protection
- Over- and Undervoltage lockout
- Cross-current protection



## Potential applications

- HVAC Flap DC motors
- Monostable and bistable relays
- Side mirror x-y adjustment
- Voltage controlled bipolar stepper motors

## Product validation

Qualified for Automotive Applications. Product Validation according to AEC-Q100

## Description

The TLE94004EP is a protected quad half-bridge driver designed especially for automotive motion control applications such as Heating, Ventilation and Air Conditioning (HVAC) flap DC motor control. It is part of a larger family offering half-bridge drivers from three outputs to twelve outputs with direct interface or SPI interface.

The half bridge drivers are designed to drive DC motor loads in sequential or parallel operation. Operation modes forward (cw), reverse (ccw), brake and high impedance are controlled from a direct interface. It offers diagnosis features such as short circuit, power supply failure and overtemperature detection. In combination with its low quiescent current, this device is attractive among others for automotive applications. The small fine pitch exposed pad package, PG-TSDSO-14, provides good thermal performance and reduces PCB-board space and costs.

Type	Package	Marking
TLE94004EP	PG-TSDSO-14	TLE94004

**Table 1 Product Summary**

Operating Voltage	$V_S$	5.5 ... 20 V
Logic Supply Voltage	$V_{DD}$	3.0 ... 5.5 V
Maximum Supply Voltage for Load Dump Protection	$V_{S(LD)}$	40 V
Minimum Overcurrent Threshold	$I_{SD}$	0.9 A
Maximum On-State Path Resistance at $T_j = 150^\circ\text{C}$	$R_{DSON(total)}_{HSx+LSy}$	1.8 + 1.8 $\Omega$
Typical Quiescent Current at $T_j = 85^\circ\text{C}$	$I_{SQ}$	0.1 $\mu\text{A}$

## Table of Contents

<b>1</b>	<b>Pin Configuration</b> .....	<b>4</b>
1.1	Pin Assignment .....	4
1.2	Pin Definitions and Functions .....	4
<b>2</b>	<b>Block Diagram</b> .....	<b>5</b>
2.1	Voltage and current definition .....	6
<b>3</b>	<b>General Product Characteristics</b> .....	<b>7</b>
3.1	Absolute Maximum Ratings .....	7
3.2	Functional Range .....	8
3.3	Thermal Resistance .....	9
3.4	Electrical Characteristics .....	10
<b>4</b>	<b>Characterization results</b> .....	<b>13</b>
<b>5</b>	<b>General Description</b> .....	<b>18</b>
5.1	Power Supply .....	18
5.2	Operation modes .....	18
5.2.1	Normal mode .....	18
5.2.2	Sleep mode .....	18
5.3	Reset Behaviour .....	18
5.4	Reverse Polarity Protection .....	18
<b>6</b>	<b>Half-Bridge Outputs</b> .....	<b>20</b>
6.1	Output Stages .....	20
6.2	Diagnosis Monitoring .....	22
6.3	Protection .....	22
6.3.1	Short Circuit of Output to Supply or Ground .....	22
6.3.2	Cross-current protection .....	23
6.3.3	Temperature monitoring and shutdown .....	25
6.3.4	VS Undervoltage Behaviour .....	27
6.3.5	VS Overvoltage Behaviour .....	28
6.3.6	V <sub>DD</sub> Undervoltage .....	28
<b>7</b>	<b>Application Information</b> .....	<b>29</b>
7.1	Application Diagram .....	29
7.2	Thermal application information .....	32
<b>8</b>	<b>Package Outlines</b> .....	<b>33</b>
<b>9</b>	<b>Revision History</b> .....	<b>34</b>

## Pin Configuration

### 1 Pin Configuration

#### 1.1 Pin Assignment

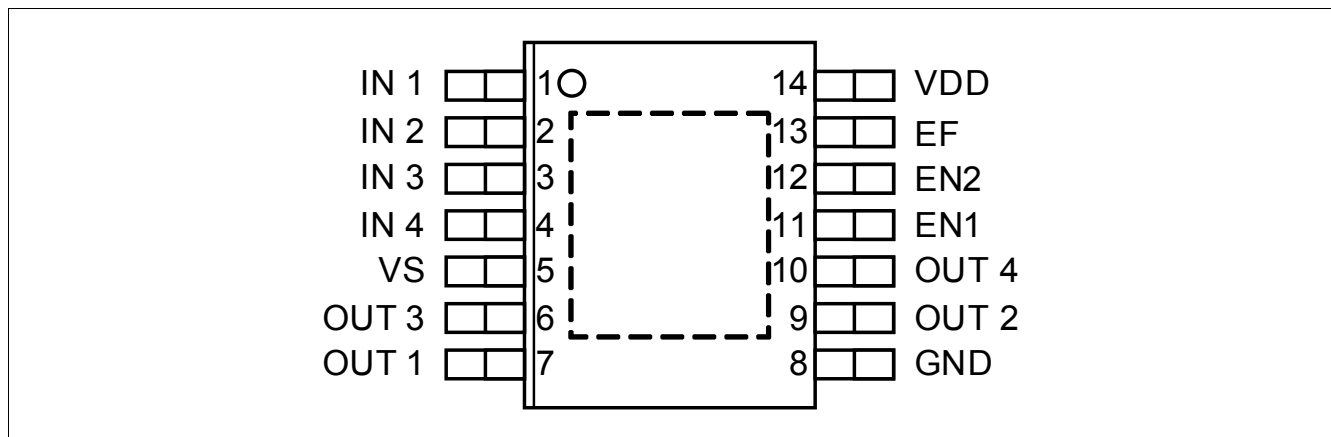

Figure 1 Pin Configuration TLE94004EP with direct interface

#### 1.2 Pin Definitions and Functions

Pin	Symbol	Function
1	IN 1	Direct input control for power half-bridge 1
2	IN 2	Direct input control for power half-bridge 2
3	IN 3	Direct input control for power half-bridge 3
4	IN 4	Direct input control for power half-bridge 4
5	VS	Main supply voltage for power half bridges.
6	OUT 3	Power half-bridge 3
7	OUT 1	Power half-bridge 1
8	GND	Ground
9	OUT 2	Power half-bridge 2
10	OUT 4	Power half-bridge 4
11	EN1	Enable input for Half-bridges 1/2 with internal pull-down
12	EN2	Enable input for Half-bridges 3/4 with internal pull-down
13	EF	Error Flag
14	VDD	Logic supply voltage
EDP	-	Exposed Die Pad; For cooling and EMC purposes only - not usable as electrical ground. Electrical ground must be provided by pins 8. <sup>1)</sup>

1) The exposed die pad at the bottom of the package allows better heat dissipation from the device via the PCB. The exposed pad (EP) must be either left open or connected to GND. It is recommended to connect EP to GND for best EMC and thermal performance.

Block Diagram

2 Block Diagram

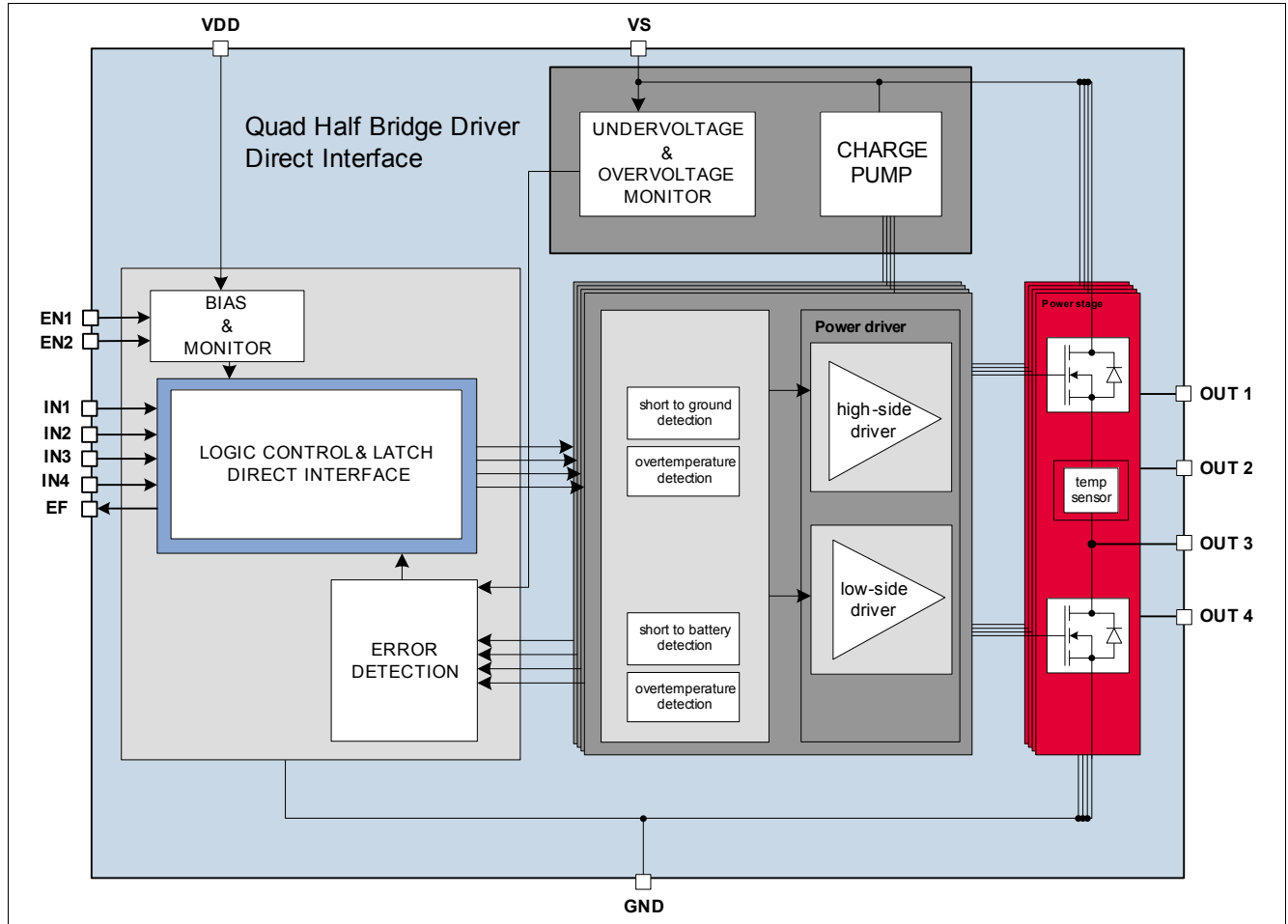

Figure 2 Block Diagram TLE94004EP (Direct Interface)

Block Diagram

2.1 Voltage and current definition

Figure 3 shows terms used in this datasheet, with associated convention for positive values.

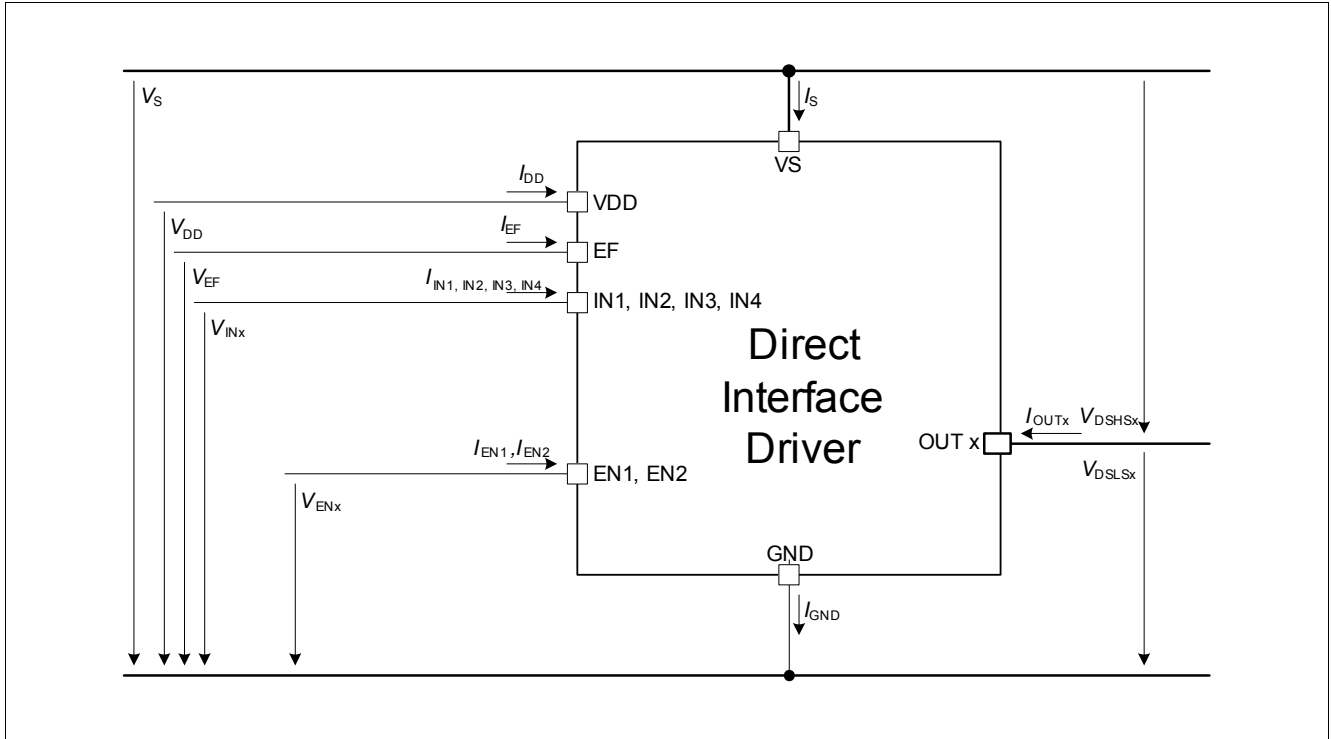

Figure 3 Voltage and Current Definition

## General Product Characteristics

### 3 General Product Characteristics

#### 3.1 Absolute Maximum Ratings

**Table 2 Absolute Maximum Ratings<sup>1)</sup>  $T_j = -40^\circ\text{C}$  to  $+150^\circ\text{C}$**

Parameter	Symbol	Values			Unit	Note or Test Condition	Number
		Min.	Typ.	Max.			
<b>Voltages</b>							
Supply voltage	$V_S$	-0.3	–	40	V		P_4.1.1
Supply Voltage Slew Rate	$ dV_S/dt $	–	–	10	V/ $\mu\text{s}$	$V_S$ increasing and decreasing <sup>1)</sup>	P_4.2.2
Power half-bridge output voltage	$V_{\text{OUT}}$	-0.3	–	40	V	$0\text{ V} < V_{\text{OUT}} < V_S$	P_4.1.2
Logic supply voltage	$V_{\text{DD}}$	-0.3	–	5.5	V	$0\text{ V} < V_S < 40\text{ V}$	P_4.1.3
Logic input voltages (EN1, EN2, IN1, IN2, IN3, IN4)	$V_{\text{ENn}}, V_{\text{INn}}$	-0.3	–	VDD	V	$0\text{ V} < V_S < 40\text{ V}$ $0\text{ V} < V_{\text{DD}} < 5.5\text{ V}$	P_4.1.16
Logic output voltage (EF)	$V_{\text{EF}}$	-0.3	–	VDD	V	$0\text{ V} < V_S < 40\text{ V}$ $0\text{ V} < V_{\text{DD}} < 5.5\text{ V}$	P_4.1.17
<b>Currents</b>							
Continuous Supply Current for $V_S$	$I_S$	0	–	2.0	A	–	P_4.1.20
Current per GND pin	$I_{\text{GND}}$	0	–	2.0	A	–	P_4.1.14
Output Currents	$I_{\text{OUT}}$	-2.0	–	2.0	A	–	P_4.1.15
<b>Temperatures</b>							
Junction temperature	$T_j$	-40	–	150	$^\circ\text{C}$	–	P_4.1.8
Storage temperature	$T_{\text{stg}}$	-50	–	150	$^\circ\text{C}$	–	P_4.1.9
<b>ESD Susceptibility</b>							
ESD susceptibility OUTn and VS pins versus GND. All other pins grounded.	$V_{\text{ESD}}$	-4	–	4	kV	JEDEC HBM <sup>1)2)</sup>	P_4.1.10
ESD susceptibility all pins	$V_{\text{ESD}}$	-2	–	2	kV	JEDEC HBM <sup>1)2)</sup>	P_4.1.11
ESD susceptibility all pins	$V_{\text{ESD}}$	-500	–	500	V	CDM <sup>1)3)</sup>	P_4.1.12
ESD susceptibility corner pins	$V_{\text{ESD}}$	-750	–	750	V	CDM <sup>1)3)</sup>	P_4.1.13

1) Not subject to production test, specified by design

2) ESD susceptibility, "JEDEC HBM" according to ANSI/ ESDA/ JEDEC JS001 (1.5 k $\Omega$ , 100pF)

3) ESD susceptibility, Charged Device Model "CDM" according JEDEC JESD22-C101

#### Notes

1. Stresses above the ones listed here may cause permanent damage to the device. Exposure to absolute maximum rating conditions for extended periods may affect device reliability.
2. Integrated protection functions are designed to prevent IC destruction under fault conditions described in the data sheet. Fault conditions are considered as "outside" normal operating range. Protection functions are not designed for continuous repetitive operation.

---

**General Product Characteristics**
**3.2 Functional Range**
**Table 3 Functional Range**

Parameter	Symbol	Values			Unit	Note or Test Condition	Number
		Min.	Typ.	Max.			
Supply voltage range for normal operation	$V_{S(nor)}$	5.5	–	20	V	–	P_4.2.1
Logic supply voltage range for normal operation	$V_{DD}$	3.0	–	5.5	V	–	P_4.2.3
Logic input voltages (EN1, EN2, IN1, IN2, IN3, IN4)	$V_{INn}, V_{ENn}$	-0.3	–	5.5	V	–	P_4.2.6
Junction temperature	$T_j$	-40	–	150	°C		P_4.2.5

*Note: Within the normal functional range the IC operates as described in the circuit description. The electrical characteristics are specified within the conditions given in the related electrical characteristics table.*



## General Product Characteristics

### 3.3 Thermal Resistance

**Table 4 Thermal Resistance TLE94004EP**

Parameter	Symbol	Values			Unit	Note or Test Condition	Number
		Min.	Typ.	Max.			
Junction to Case, $T_A = -40^\circ\text{C}$	$R_{thjC\_cold}$	–	14	–	K/W	1)	
Junction to Case, $T_A = 85^\circ\text{C}$	$R_{thjC\_hot}$	–	17	–	K/W	1)	
Junction to ambient, $T_A = -40^\circ\text{C}$ (1s0p, minimal footprint)	$R_{thjA\_cold\_min}$	–	126	–	K/W	1) 2)	
Junction to ambient, $T_A = 85^\circ\text{C}$ (1s0p, minimal footprint)	$R_{thjA\_hot\_min}$	–	134	–	K/W	1) 2)	
Junction to ambient, $T_A = -40^\circ\text{C}$ (1s0p, 300mm <sup>2</sup> Cu)	$R_{thjA\_cold\_300}$	–	69	–	K/W	1) 3)	
Junction to ambient, $T_A = 85^\circ\text{C}$ (1s0p, 300mm <sup>2</sup> Cu)	$R_{thjA\_hot\_300}$	–	81	–	K/W	1) 3)	
Junction to ambient, $T_A = -40^\circ\text{C}$ (1s0p, 600mm <sup>2</sup> Cu)	$R_{thjA\_cold\_600}$	–	67	–	K/W	1) 4)	
Junction to ambient, $T_A = 85^\circ\text{C}$ (1s0p, 600mm <sup>2</sup> Cu)	$R_{thjA\_hot\_600}$	–	79	–	K/W	1) 4)	
Junction to ambient, $T_A = -40^\circ\text{C}$ (2s2p)	$R_{thjA\_cold\_2s2p}$	–	53	–	K/W	1) 5)	
Junction to ambient, $T_A = 85^\circ\text{C}$ (2s2p)	$R_{thjA\_hot\_2s2p}$	–	67	–	K/W	1) 5)	

1) Not subject to production test, specified by design.

2) Specified  $R_{thjA}$  value is according to JEDEC JESD51-2, -3 at natural convection on FR4 1s0p board; The product (chip + package) was simulated on a 76.2 x 114.3 x 1.5mm board with minimal footprint copper area and 35 $\mu\text{m}$  thickness.  $T_a = -40^\circ\text{C}$ , each channel dissipates 0.2W.  $T_a = 85^\circ\text{C}$ , each channel dissipates 0.135W.

3) Specified  $R_{thjA}$  value is according to JEDEC JESD51-2, -3 at natural convection on FR4 1s0p board; The product (chip + package) was simulated on a 76.2 x 114.3 x 1.5mm board with additional cooling of 300mm<sup>2</sup> copper area and 35 $\mu\text{m}$  thickness.  $T_a = -40^\circ\text{C}$ , each channel dissipates 0.2W.  $T_a = 85^\circ\text{C}$ , each channel dissipates 0.135W.

4) Specified  $R_{thjA}$  value is according to JEDEC JESD51-2, -3 at natural convection on FR4 1s0p board; The product (chip + package) was simulated on a 76.2 x 114.3 x 1.5mm board with additional cooling of 600mm<sup>2</sup> copper area and 35 $\mu\text{m}$  thickness.  $T_a = -40^\circ\text{C}$ , each channel dissipates 0.2W.  $T_a = 85^\circ\text{C}$ , each channel dissipates 0.135W.

5) Specified  $R_{thjA}$  value is according to JEDEC JESD51-2, -3 at natural convection on FR4 2s2p board; The product (chip + package) was simulated on a 76.2 x 114.3 x 1.5mm board with two inner copper layers ( 4 x 35 $\mu\text{m}$  Cu).  $T_a = -40^\circ\text{C}$ , each channel dissipates 0.2W.  $T_a = 85^\circ\text{C}$ , each channel dissipates 0.135W.

## General Product Characteristics

### 3.4 Electrical Characteristics

**Table 5** Electrical Characteristics,  $V_S=5.5\text{ V to }20\text{ V}$ ,  $V_{DD} = 3.0\text{ V to }5.5\text{ V}$ ,  $T_j = -40^\circ\text{C to }+150^\circ\text{C}$ , EN1= HIGH and EN2= HIGH,  $I_{OUTn} = 0\text{ A}$ ; Typical values refer to  $V_{DD} = 5.0\text{ V}$ ,  $V_S = 13.5\text{ V}$  and  $T_j = 25^\circ\text{C}$  unless otherwise specified; all voltages with respect to ground, positive current flowing into pin (unless otherwise specified)

Parameter	Symbol	Values			Unit	Note or Test Condition	Number
		Min.	Typ.	Max.			
<b>Current Consumption, EN1 = EN2 = GND</b>							
Supply Quiescent current	$I_{SQ}$	–	0.1	2	$\mu\text{A}$	$-40^\circ\text{C} \leq T_j \leq 85^\circ\text{C}$	P_4.4.1
Logic supply quiescent current	$I_{DD\_Q}$	–	0.1	1	$\mu\text{A}$	$-40^\circ\text{C} \leq T_j \leq 85^\circ\text{C}$	P_4.4.2
Total quiescent current	$I_{SQ} + I_{DD\_Q}$	–	0.6	3	$\mu\text{A}$	$-40^\circ\text{C} \leq T_j \leq 85^\circ\text{C}$	P_4.4.3
<b>Current Consumption, EN=HIGH</b>							
Supply current	$I_{S\_HSON}$	–	1.5	3	mA	All high-sides ON <sup>1)2)</sup>	P_4.4.101
Logic supply current	$I_{DD}$	–	0.6	2.5	mA		P_4.4.5
<b>Over- and Undervoltage Lockout</b>							
Undervoltage Switch ON voltage threshold	$V_{UV\ ON}$	4.4	4.90	5.3	V	$V_S$ increasing	P_4.4.8
Undervoltage Switch OFF voltage threshold	$V_{UV\ OFF}$	4	4.50	4.9	V	$V_S$ decreasing	P_4.4.9
Undervoltage Switch ON/OFF hysteresis	$V_{UV\ HY}$	–	0.40	–	V	$V_{UV\ ON} - V_{UV\ OFF}$ <sup>2)</sup>	P_4.4.10
Oversvoltage Switch OFF voltage threshold	$V_{OV\ OFF}$	21	23	25	V	$V_S$ increasing	P_4.4.11
Oversvoltage Switch ON voltage threshold	$V_{OV\ ON}$	20	22	24	V	$V_S$ decreasing	P_4.4.12
Oversvoltage Switch ON/OFF hysteresis	$V_{OV\ HY}$	–	1	–	V	$V_{OV\ OFF} - V_{OV\ ON}$ <sup>2)</sup>	P_4.4.13
$V_{DD}$ Power-On-Reset	$V_{DD\ POR}$	2.40	2.63	2.90	V	$V_{DD}$ increasing	P_4.4.14
$V_{DD}$ Power-Off-Reset	$V_{DD\ PoffR}$	2.35	2.57	2.85	V	$V_{DD}$ decreasing	P_4.4.15
$V_{DD}$ Power ON/OFF hysteresis	$V_{DD\ POR\ HY}$	–	0.06	–	V	$V_{DD\ POR} - V_{DD\ PoffR}$ <sup>2)</sup>	P_4.4.98
<b>Static Drain-source ON-Resistance (High-Side or Low-Side)</b>							
High-Side or Low-Side $R_{DSON}$ (all outputs)	$R_{DSON\_HB\_25C}$	–	825	1200	m $\Omega$	$I_{OUT} = \pm 0.5\text{ A}$ ; $T_j = 25^\circ\text{C}$	P_4.4.16
High-Side or Low-Side $R_{DSON}$ (all outputs)	$R_{DSON\_HB\_150C}$	–	1350	1800	m $\Omega$	$I_{OUT} = \pm 0.5\text{ A}$ ; $T_j = 150^\circ\text{C}$	P_4.4.17
<b>Output Protection and Diagnosis of high-side (HS) channels of half-bridge output</b>							
HS Overcurrent Shutdown Threshold	$I_{SD\_HS}$	-1.5	-1.2	-0.9	A	See <b>Figure 6</b>	P_4.4.20
Difference between shutdown and limit current	$I_{LIM\_HS} - I_{SD\_HS}$	-1.2	-0.6	0	A	<sup>2)</sup> $ I_{LIM\_HS}  \geq  I_{SD\_HS} $ See <b>Figure 6</b>	P_4.4.21

## General Product Characteristics

**Table 5 Electrical Characteristics,  $V_S = 5.5\text{ V to }20\text{ V}$ ,  $V_{DD} = 3.0\text{ V to }5.5\text{ V}$ ,  $T_j = -40^\circ\text{C to }+150^\circ\text{C}$ , EN1= HIGH and EN2= HIGH,  $I_{OUTn} = 0\text{ A}$ ; Typical values refer to  $V_{DD} = 5.0\text{ V}$ ,  $V_S = 13.5\text{ V}$  and  $T_j = 25^\circ\text{C}$  unless otherwise specified; all voltages with respect to ground, positive current flowing into pin (unless otherwise specified) (cont'd)**

Parameter	Symbol	Values			Unit	Note or Test Condition	Number
		Min.	Typ.	Max.			
Overcurrent Shutdown filter time	$t_{dSD\_HS}$	15	19	23	$\mu\text{s}$	<sup>2)</sup>	P_4.4.22

### Output Protection and Diagnosis of low-side (LS) channels of half-bridge output

LS Overcurrent Shutdown Threshold	$I_{SD\_LS}$	0.9	1.2	1.5	A	See <a href="#">Figure 7</a>	P_4.4.27
Difference between shutdown and limit current	$I_{LIM\_LS} - I_{SD\_LS}$	0	0.6	1.2	A	<sup>2)</sup> $I_{LIM\_LS} \geq I_{SD\_LS}$ <a href="#">Figure 7</a>	P_4.4.28
Overcurrent Shutdown filter time	$t_{dSD\_LS}$	15	19	23	$\mu\text{s}$	<sup>2)</sup>	P_4.4.29

### Outputs OUT(1...n) leakage current

HS leakage current in off state	$I_{QLHn\_NOR}$	-2	-0.5	-	$\mu\text{A}$	$V_{OUTn} = 0\text{V}$ ; OUT1/2: EN1=GND, EN2=High; OUT3/4: EN1=High, EN2=GN D	P_4.4.32
HS leakage current in off state	$I_{QLHn\_SLE}$	-2	-0.5	-	$\mu\text{A}$	$V_{OUTn} = 0\text{V}$ ; EN1 = EN2 =GND	P_4.4.33
LS Leakage current in off state	$I_{QLLn\_NOR}$	-	0.5	2	$\mu\text{A}$	$V_{OUTn} = V_S$ ; OUT1/2: EN1=GND, EN2=High; OUT3/4: EN1=High, EN2=GN D	P_4.4.34
LS Leakage current in off state	$I_{QLLn\_SLE}$	-	0.5	2	$\mu\text{A}$	$V_{OUTn} = V_S$ ; EN1 = EN2 =GND	P_4.4.35

### Output Switching Times. See [Figure 8](#) and [Figure 9](#).

Slew rate of high-side and low-side outputs	$d_{VOUT}/dt$	0.1	0.45	0.75	$\text{V}/\mu\text{s}$	Resistive load = $100\Omega$ ; $V_S = 13.5\text{V}$ <sup>3)</sup>	P_4.4.36
Output delay time high side driver on	$t_{dONH}$	5	20	35	$\mu\text{s}$	Resistive load = $100\Omega$ to GND	P_4.4.37
Output delay time high side driver off	$t_{dOFFH}$	15	45	75	$\mu\text{s}$	Resistive load = $100\Omega$ to GND	P_4.4.38
Output delay time low side driver on	$t_{dONL}$	5	20	35	$\mu\text{s}$	Resistive load = $100\Omega$ to VS	P_4.4.39
Output delay time low side driver off	$t_{dOFFL}$	15	45	75	$\mu\text{s}$	Resistive load = $100\Omega$ to VS	P_4.4.40
Cross current protection time, high to low	$t_{DHL}$	100	130	160	$\mu\text{s}$	Resistive load = $100\Omega$ <sup>2)</sup>	P_4.4.41
Cross current protection time, low to high	$t_{DLH}$	100	130	160	$\mu\text{s}$	Resistive load = $100\Omega$ <sup>2)</sup>	P_4.4.42

## General Product Characteristics

**Table 5** Electrical Characteristics,  $V_S = 5.5\text{ V to }20\text{ V}$ ,  $V_{DD} = 3.0\text{ V to }5.5\text{ V}$ ,  $T_j = -40^\circ\text{C to }+150^\circ\text{C}$ , EN1= HIGH and EN2= HIGH,  $I_{OUTn} = 0\text{ A}$ ; Typical values refer to  $V_{DD} = 5.0\text{ V}$ ,  $V_S = 13.5\text{ V}$  and  $T_j = 25^\circ\text{C}$  unless otherwise specified; all voltages with respect to ground, positive current flowing into pin (unless otherwise specified) (cont'd)

Parameter	Symbol	Values			Unit	Note or Test Condition	Number
		Min.	Typ.	Max.			
<b>Input Interface: Logic Inputs EN1, EN2</b>							
Set up time after sleep mode	$t_{SET\_DI}$	–	–	150	$\mu\text{s}$	<sup>2)</sup> See <a href="#">Figure 5</a>	P_4.4.49
High-input voltage	$V_{ENH}$	0.7 * $V_{DD}$	–	$V_{DD}$	V	–	P_4.4.43
Low-input voltage	$V_{ENL}$	0	–	0.3 * $V_{DD}$	V	–	P_4.4.44
Hysteresis of input voltage	$V_{ENHY}$	–	500	–	mV	<sup>2)</sup>	P_4.4.45
Pull down resistor	$R_{PD\_EN}$	20	40	70	k $\Omega$	$V_{EN1/2} = 0.2 \times V_{DD}$	P_4.4.46
EF reset time	$t_{EF\_RESET}$	250	–	–	ns	<sup>2)</sup> Set ENx to Low for $t_{EF\_RESET}$ to reset EF	P_4.4.121
<b>Input Interface: Logic Inputs IN1, IN2, IN3, IN4</b>							
High input voltage threshold	$V_{INnH}$	0.7 * $V_{DD}$	–	$V_{DD}$	V	–	P_4.4.90
Low input voltage threshold	$V_{INnL}$	0	–	0.3 * $V_{DD}$	V	–	P_4.4.91
Hysteresis of input voltage	$V_{INnHY}$	–	500	–	mV	<sup>2)</sup>	P_4.4.92
Pull-down resistor	$R_{PD}$	20	40	70	k $\Omega$	–	P_4.4.94
<b>Output Interface: Logic Output EF</b>							
High output voltage level	$V_{EFH}$	$V_{DD} - 0.4$	$V_{DD} - 0.2$	$V_{DD}$	V	$I_{EFH} = -1.6\text{ mA}$	P_4.4.88
Low output voltage level	$V_{EFL}$	0	0.2	0.4	V	$I_{EFL} = 1.6\text{ mA}$	P_4.4.95
Leakage current	$I_{EFLK}$	-1	–	1	$\mu\text{A}$	$0\text{ V} < V_{EF} < 5.5\text{ V}$	P_4.4.96
<b>Thermal Shutdown</b>							
Thermal shutdown junction temperature	$T_{jSD}$	160	175	190	$^\circ\text{C}$	See <a href="#">Figure 10</a> <sup>2)</sup>	P_4.4.81
Thermal comparator hysteresis	$T_{jHYS}$	–	4	–	$^\circ\text{C}$	<sup>2)</sup>	P_4.4.82

1)  $I_{S\_HSON}$  does not include the load current

2) Not subject to production test, specified by design

3) Measured for 20% - 80% of  $V_S$ .

Characterization results

### 4 Characterization results

Performed on 5 devices, over operating temperature and nominal/extended supply range.

Typical performance characteristics

#### Supply quiescent current

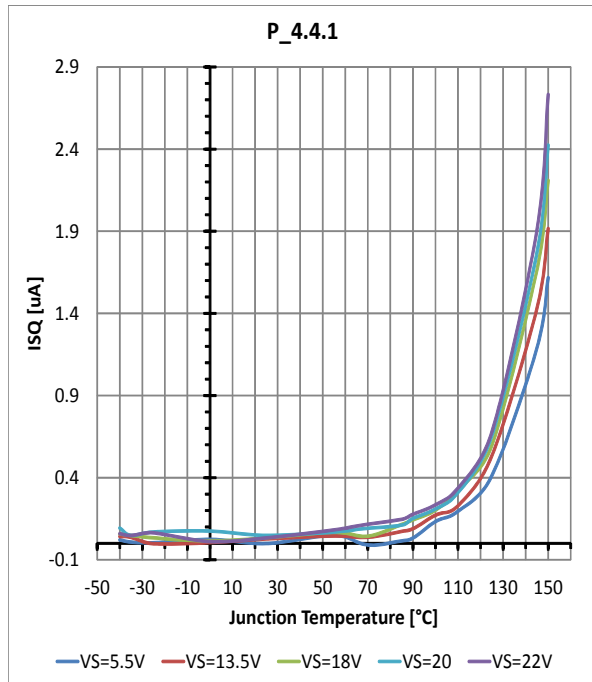

#### Supply current

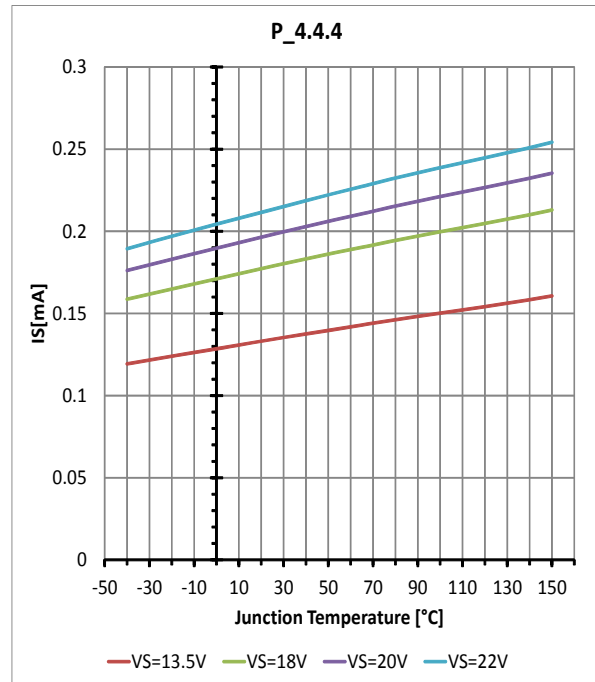

#### Logic supply quiescent current

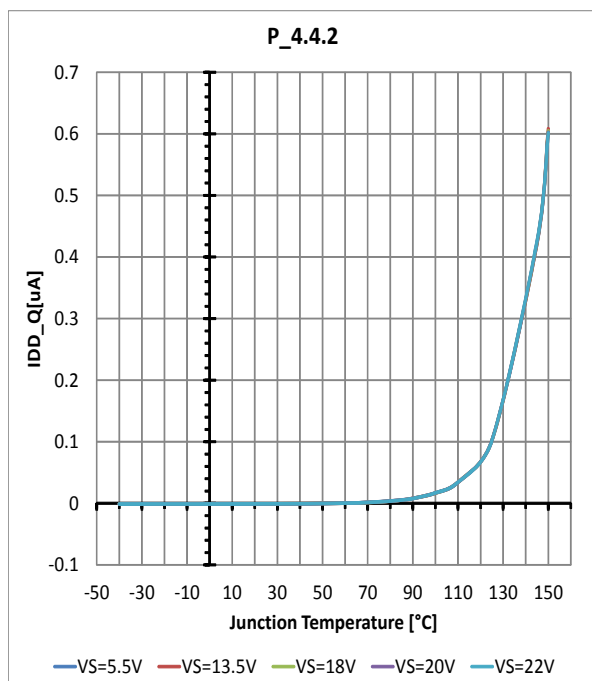

#### Logic supply current

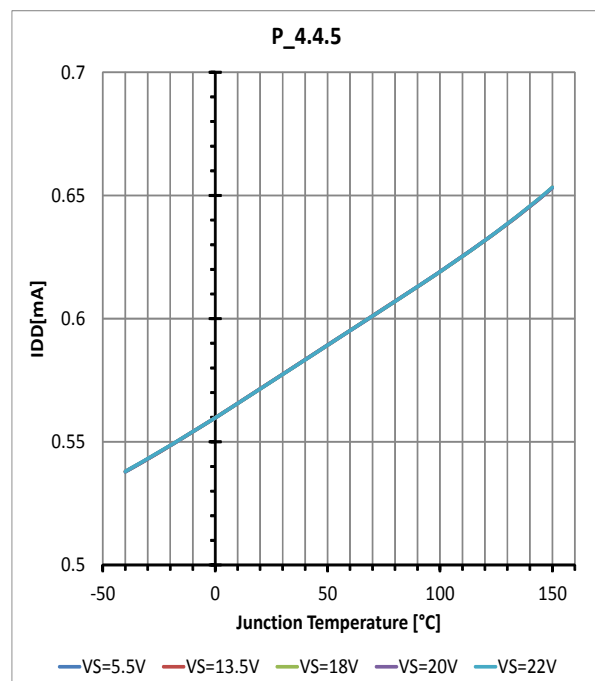

Characterization results

HS static Drain-source ON-resistance

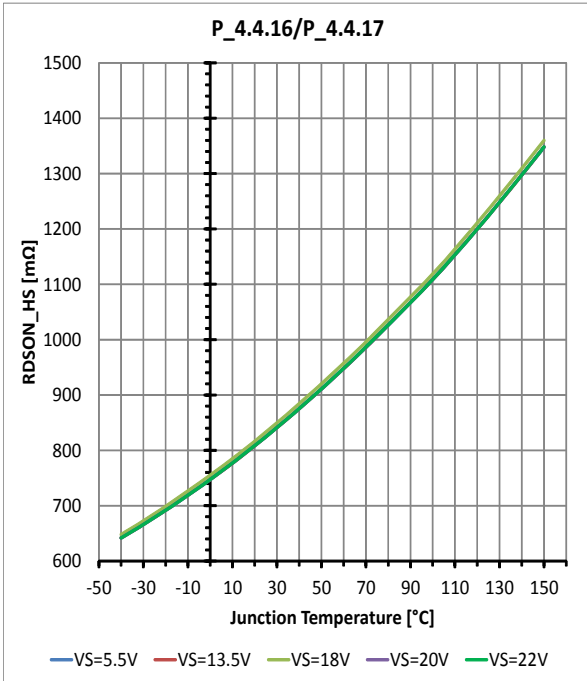

LS static Drain-source ON-resistance

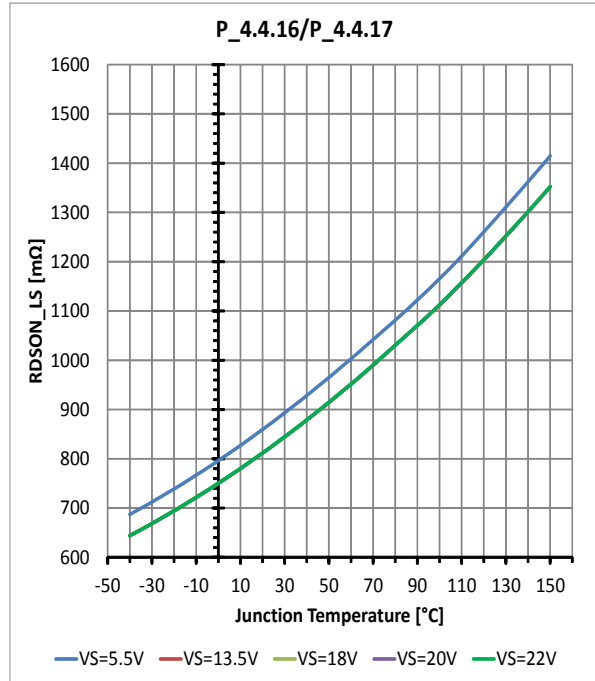

HS static drain-source ON-resistance  
VS = 13.5V and VDD = 5V

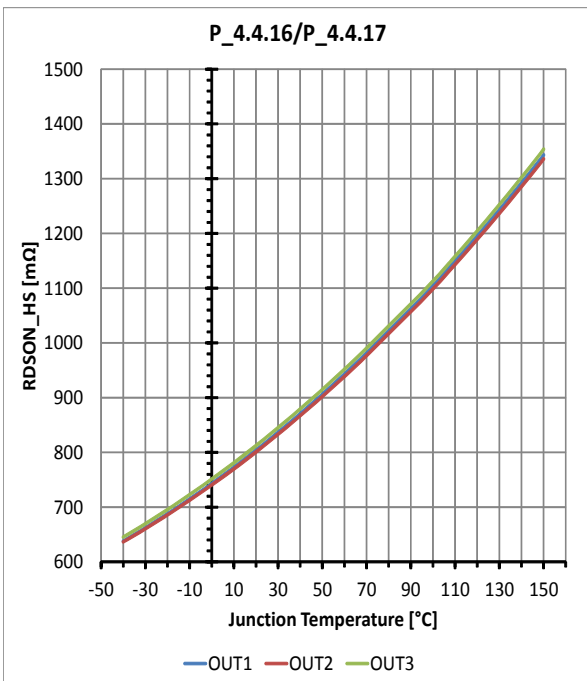

LS static drain-source ON-resistance  
VS = 13.5V and VDD = 5V

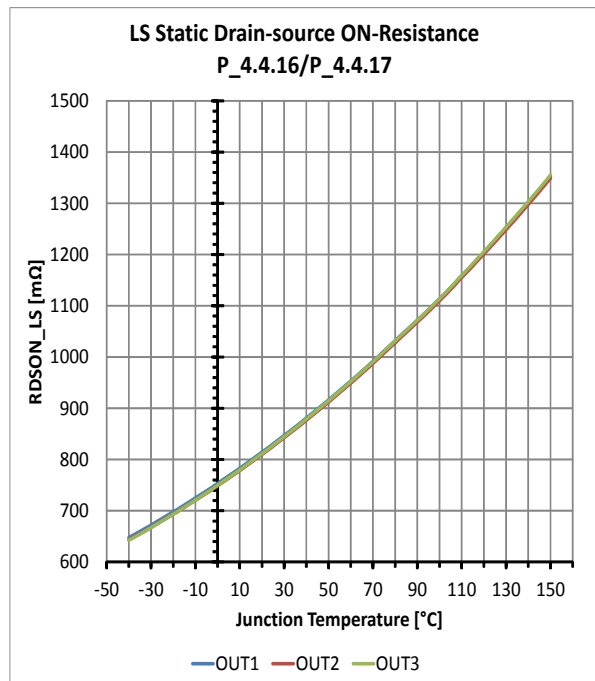

Characterization results

Slew rate ON of high-side outputs

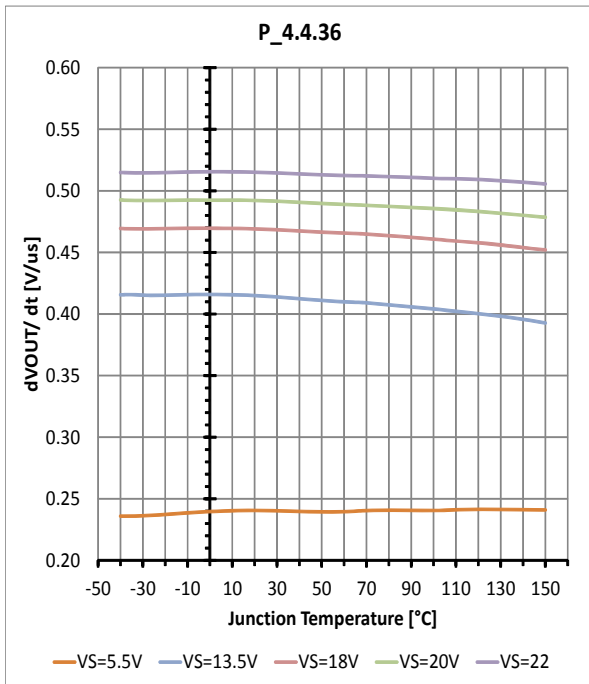

Slew rate ON of low-side outputs

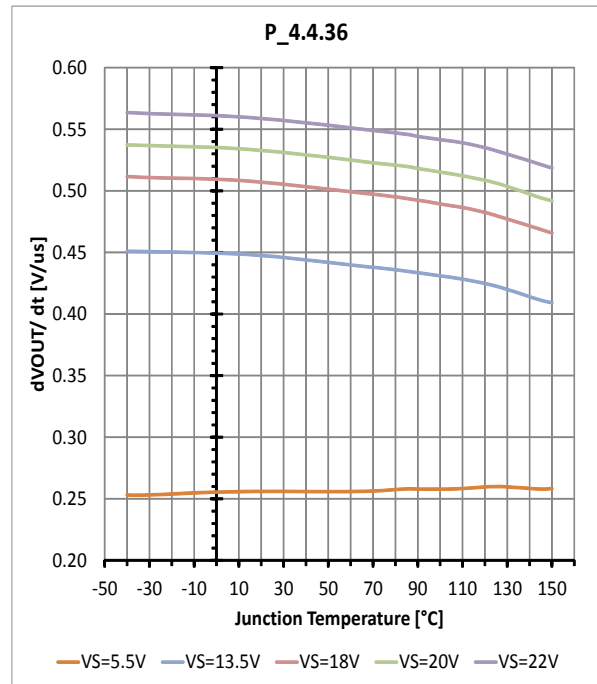

Slew rate OFF of high-side outputs

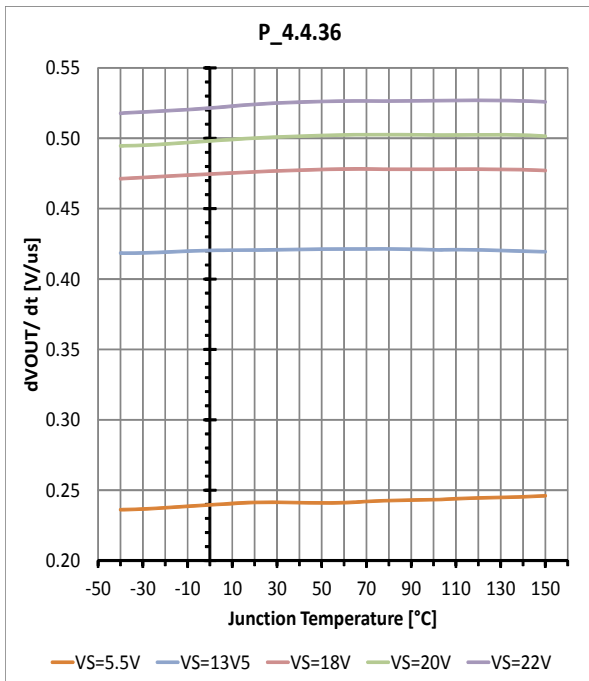

Slew rate OFF of low-side outputs

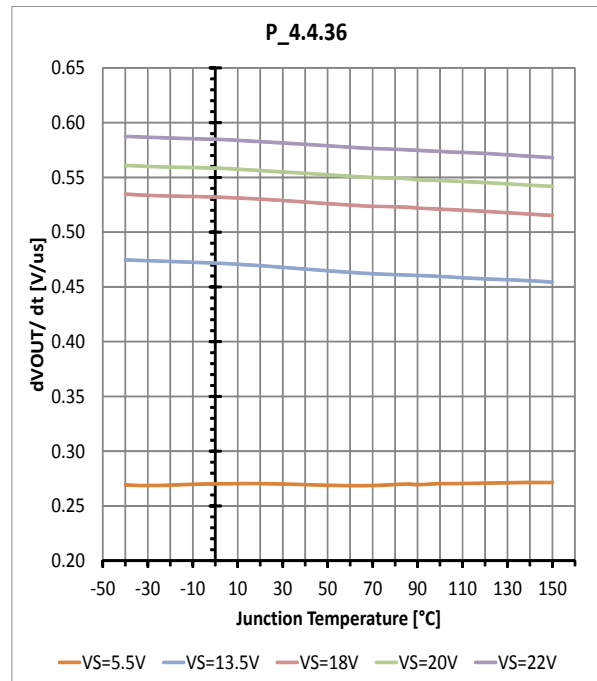

Characterization results

HS overcurrent shutdown threshold

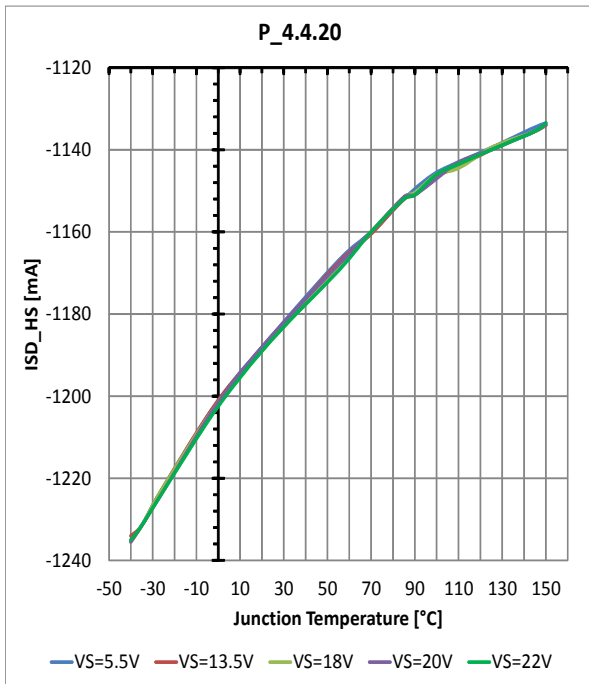

LS overcurrent shutdown threshold

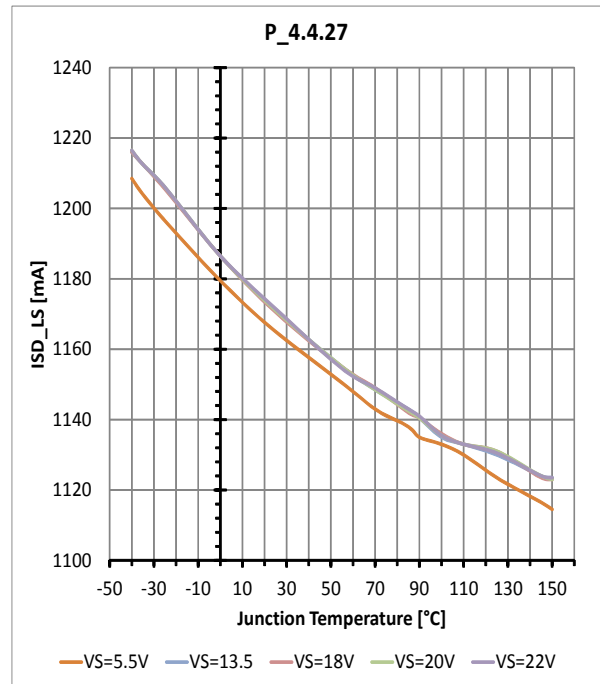

Undervoltage switch ON voltage threshold

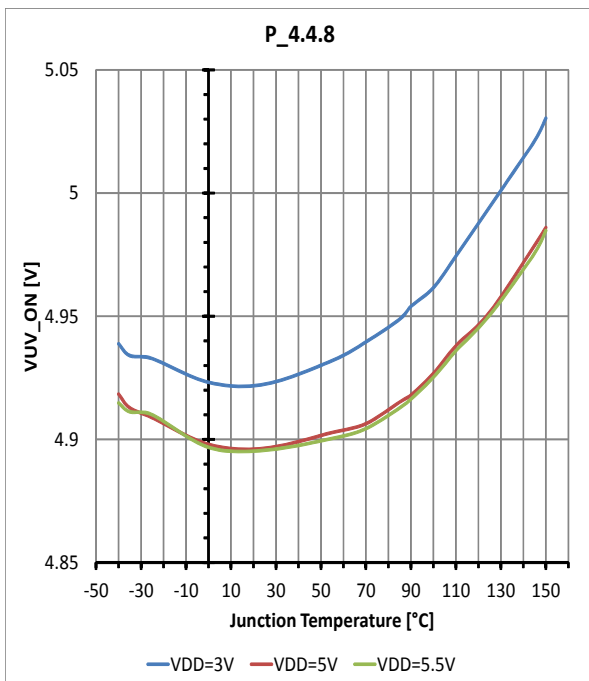

Undervoltage switch OFF voltage threshold

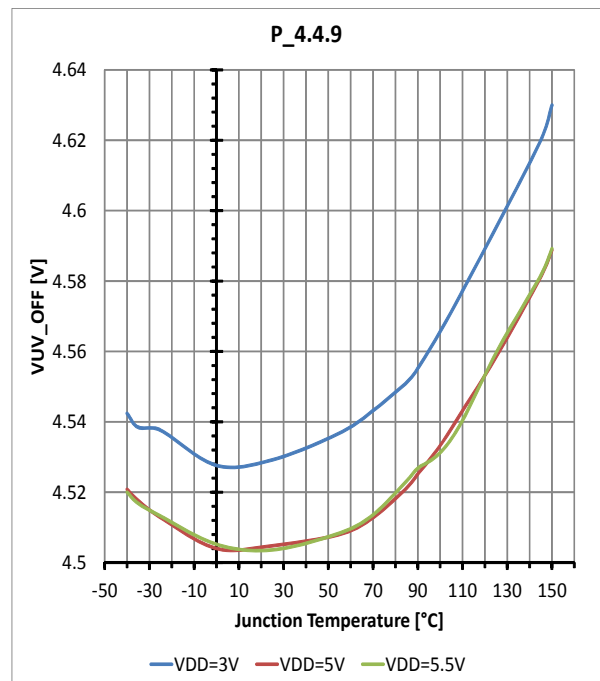



Characterization results

Overvoltage switch ON voltage threshold

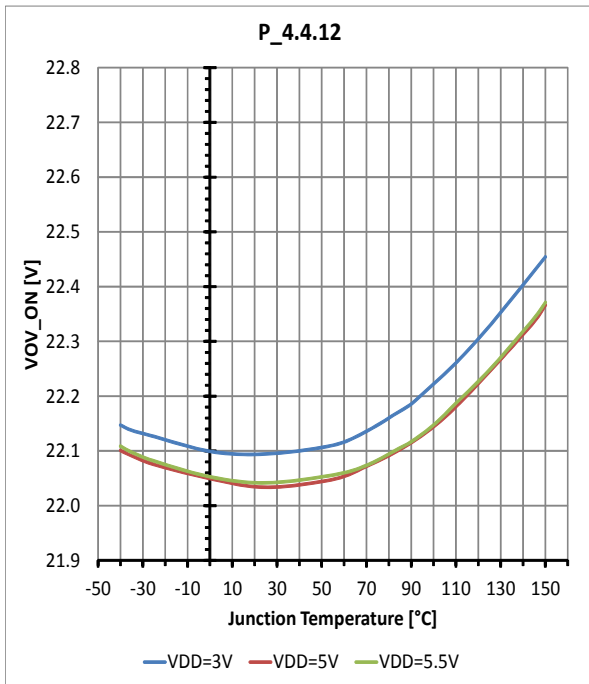

Overvoltage switch OFF voltage threshold

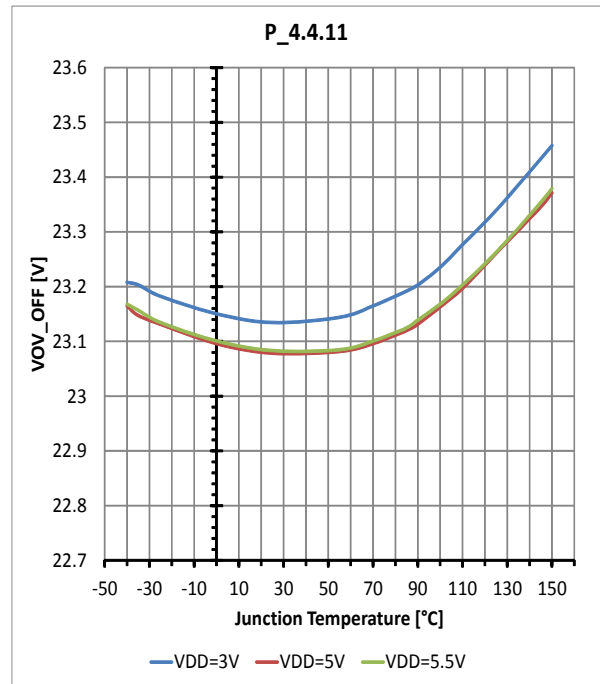

VDD Power-on-reset and VDD Power-off-reset

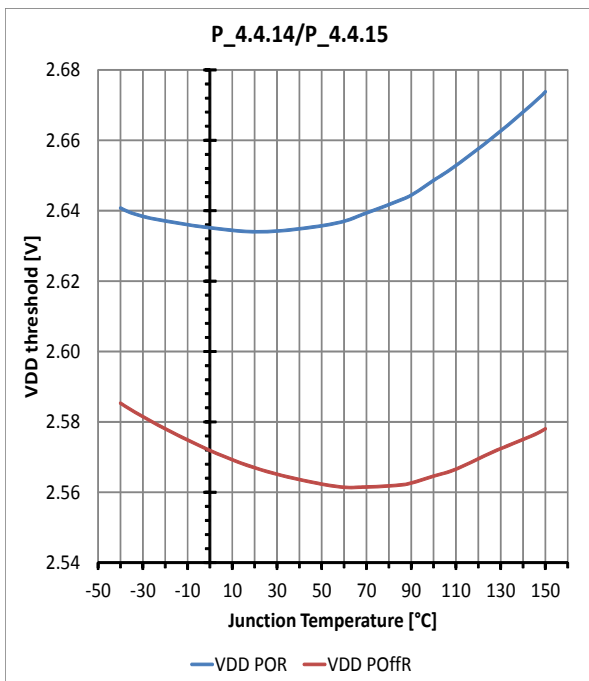

## General Description

# 5 General Description

## 5.1 Power Supply

The TLE94004EP has two power supply inputs,  $V_S$  and  $V_{DD}$ . The half bridge outputs are supplied by  $V_S$ , which is connected to the 12V automotive supply rail.  $V_{DD}$  is used to supply the I/O buffers and internal voltage regulator of the device.

$V_S$  and  $V_{DD}$  supplies are separated so that information stored in the logic block remains intact in the event of voltage drop outs or disturbances on  $V_S$ . The system can therefore continue to operate once  $V_S$  has recovered, without having to resend commands to the device.

A rising edge on  $V_{DD}$  crossing  $V_{DD\text{POR}}$  triggers an internal Power-On Reset (POR) to initialize the IC at power-on. All data stored internally is deleted, and the outputs are switched off (high impedance).

An electrolytic and 100nF ceramic capacitors are recommended to be placed as close as possible to the  $V_S$  supply pin of the device for improved EMC performance in the high and low frequency band. The electrolytic capacitor must be dimensioned to prevent the  $V_S$  voltage from exceeding the absolute maximum rating. In addition, decoupling capacitors are recommended on the  $V_{DD}$  supply pin.

## 5.2 Operation modes

### 5.2.1 Normal mode

The TLE94004EP enters normal mode by setting EN1 or EN2 to High. In normal mode, the charge pump is active and all output transistors can be activated or deactivated according to [Chapter 6.1](#).

### 5.2.2 Sleep mode

The TLE94004EP enters sleep mode by setting the EN1 and EN2 pins to Low. The EN1 and EN2 inputs have an internal pull-down resistor.

In sleep mode, all output transistors are turned off and the logic content is reset. The current consumption is reduced to  $I_{SQ} + I_{DD\_Q}$ .

## 5.3 Reset Behaviour

The following reset triggers have been implemented in the TLE94004EP:

### $V_{DD}$ Undervoltage Reset:

The digital block will be deactivated, the logic contents cleared and the output stages are switched off if  $V_{DD}$  is below the undervoltage threshold,  $V_{DD\text{POffR}}$ . The digital block is initialized once  $V_{DD}$  voltage levels is above the undervoltage threshold,  $V_{DD\text{POR}}$ .

### Reset on EN1/2 pins:

If the EN1/2 pins are pulled Low, the logic content is reset and the device enters sleep mode.

## 5.4 Reverse Polarity Protection

The TLE94004EP requires an external reverse polarity protection. During reverse polarity, the free-wheeling diodes across the half bridge output will begin to conduct, causing an undesired current flow ( $I_{RB}$ ) from ground potential to battery and excessive power dissipation across the diodes. As such, a reverse polarity protection diode is recommended (see [Figure 4](#)).

General Description

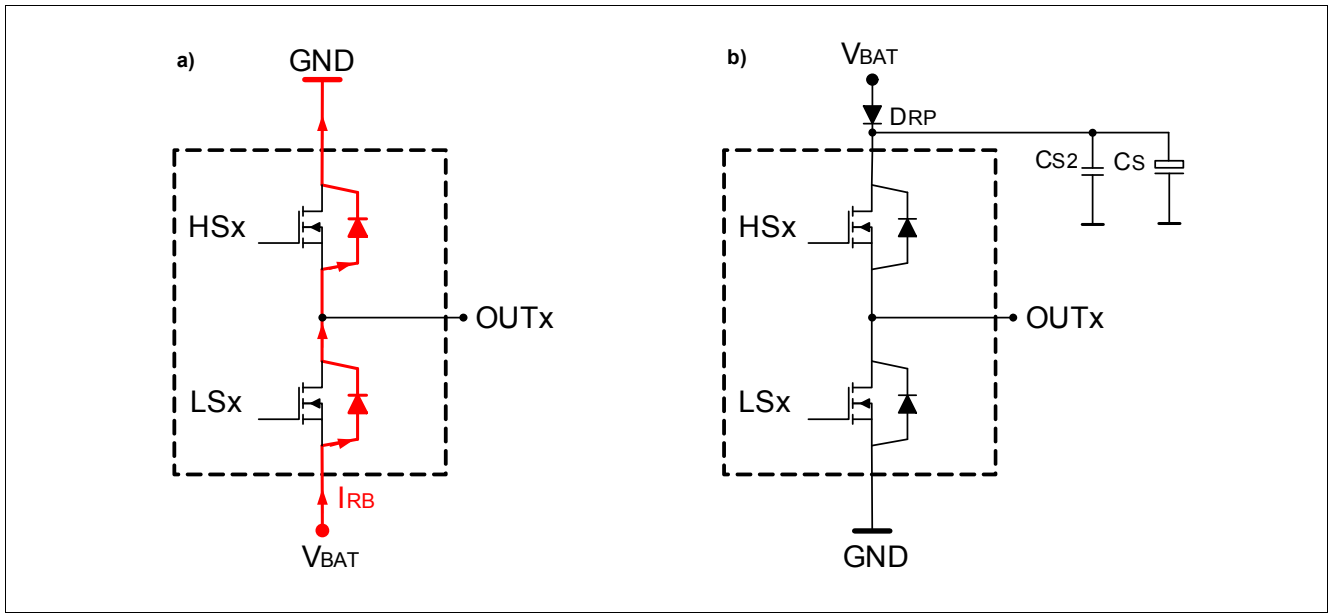

Figure 4 Reverse Polarity Protection

## Half-Bridge Outputs

### 6 Half-Bridge Outputs

The half-bridge outputs of the TLE94004EP are intended to drive motor loads. They consist of a total of four DMOS half-bridges, which can be driven either continuously or in PWM via INx pins. The output stages integrated circuits protect the outputs against overcurrent and overtemperature.

#### 6.1 Output Stages

EN1 and EN2 inputs control the state of the device according to [Table 6](#).

- When EN1 = 0 and EN2 = 0, the device enters sleep mode with low power consumption and all outputs are OFF (high impedance).
- When EN1=1, HB1 and HB2 are enabled
- When EN2=1, HB3 and HB4 are enabled

**Table 6** Device states

EN1	EN2	HB1/2	HB 3/4	Device state
0	0	OFF	OFF	Sleep mode, all outputs are OFF
0	1	OFF	Enabled	Device is in normal mode
1	0	Enabled	OFF	Device is in normal mode
1	1	Enabled	Enabled	Device is in normal mode

Note: After the transition from sleep mode to normal mode, the outputs are OFF for a duration  $t_{SET\_DI}$ . See [Figure 5](#)

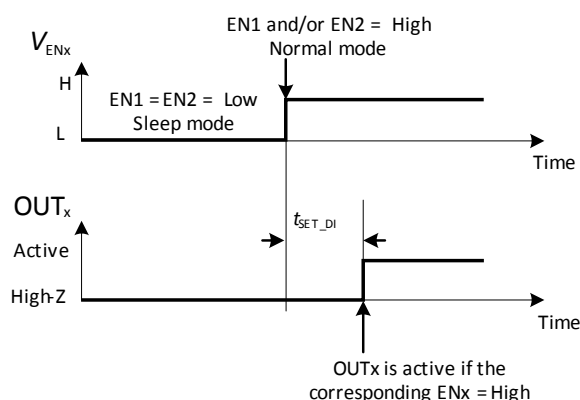

**Figure 5** Output setup time after a transition from standby to normal mode

The control inputs consist of CMOS-compatible schmitt-triggers with hysteresis. There are altogether four control inputs, i.e. IN1, IN2, IN3 and IN4 with internal pull-down resistors.

If EN1 = 0, HB1 and HB2 are OFF. If EN1 = 1, HB1 and HB2 are controlled according to [Table 7](#)

**Table 7** Functional Truth Table for HB1 and HB2

EN1	IN1	IN2	HB1	HB2	Mode
0	X	X	OFF	OFF	HB1 and HB2 are OFF
1	0	0	L	L	Brake Low

---

**Half-Bridge Outputs**
**Table 7 Functional Truth Table for HB1 and HB2**

EN1	IN1	IN2	HB1	HB2	Mode
1	0	1	L	H	Motor counter-clockwise
1	1	0	H	L	Motor clockwise
1	1	1	H	H	Brake High

If EN2 = 0, HB3 and HB4 are OFF. If EN2 =1, HB3 and HB4 are controlled according to [Table 8](#)

**Table 8 Functional Truth table for HB3 and HB4**

EN2	IN3	IN4	HB3	HB4	Mode
0	X	X	OFF	OFF	HB3 and HB4 are OFF
1	0	0	L	L	Brake Low
1	0	1	L	H	Motor counter-clockwise
1	1	0	H	L	Motor clockwise
1	1	1	H	H	Brake High

## Half-Bridge Outputs

### 6.2 Diagnosis Monitoring

The EF pin (push-pull output) reports the following error conditions:

- Overcurrent (OC)
- Overtemperature (OT)
- VS overvoltage and VS undervoltage

EF reports an overcurrent event on HB1/2 only if EN1 = 1. Likewise, EF reports an overcurrent on HB3/4 only if EN2 = 1.

After an overcurrent event is detected on HB1/2, EF is latched to 1, until EN1 = 0. Likewise, after an overcurrent event detected on HB3/4, EF is latched to 1 until EN2 = 0.

EF reports overtemperature or VS overvoltage/undervoltage events if the device is in normal mode (EN1 = 1 or EN2 = 1). The error flag is latched to 1 for these fault conditions until EN1 = 0 and EN2 = 0

**Table 9 Error reporting by EF pin**

EN1	EN2	Error reported by EF pin
0	0	Not applicable, the device is in sleep mode
1	0	OC on HB1/2, OT, VS under/overvoltage
0	1	OC on HB3/4, OT, VS under/overvoltage
1	1	OC on HB1/2, OC on HB3/4, OT, VS under/overvoltage

The table below depicts the EF behaviour:

**Table 10 Error flag behaviour and reset conditions**

Fault condition	EF	Reset conditions
No fault	0	–
Overcurrent on HB1 or HB2	1 (latched)	Set EN1 pin to 0 for $t_{EF\_RESET}$
Overcurrent on HB3 or HB4	1 (latched)	Set EN2 pin to 0 for $t_{EF\_RESET}$
VS overvoltage	1 (latched)	$V_S < V_{OV\_ON}$ , EN1 = 0 and EN2 = 0 for $t_{EF\_RESET}$
VS undervoltage	1 (latched)	$V_S > V_{UV\_ON}$ , EN1 = 0 and EN2 = 0 for $t_{EF\_RESET}$
Overtemperature	1 (latched)	EN1 = 0 and EN2 = 0 for $t_{EF\_RESET}$

### 6.3 Protection

This device has embedded protective functions which are designed to prevent the destruction of the device under fault conditions described in this section. Fault conditions are treated as “outside” normal operating range. Protection functions are not designed for continuous repetitive operation.

#### 6.3.1 Short Circuit of Output to Supply or Ground

The high-side switches are protected against short circuits to ground whereas the low-side switches are protected against short circuits to supply.

The high-side and low-side switches will enter into an over-current condition if the current within the switch exceeds the overcurrent shutdown detection threshold,  $I_{SD}$ . Upon detection of the  $I_{SD}$  threshold, an

## Half-Bridge Outputs

overcurrent shutdown filter,  $t_{dSD}$  is begun. As the current rises beyond the threshold  $I_{SD}$ , it will be limited by the current limit threshold,  $I_{LIM}$ . Upon expiry of the overcurrent shutdown filter time, the affected power switch is latched off (see [Figure 6](#) and [Figure 7](#)) and the EF is set to 1 and latched.

The faulty power switch remains deactivated and EF is latched as long as the corresponding  $ENx = 1$ .

To resume normal functionality of the power switch (in the event the overcurrent condition disappears or to verify if the failure still exists) the microcontroller shall:

1. clear the error flag by setting the corresponding  $ENx$  to 0 (see [Table 10](#))
2. set the corresponding  $ENx$  to 1 in order to re-enable the corresponding half-bridges

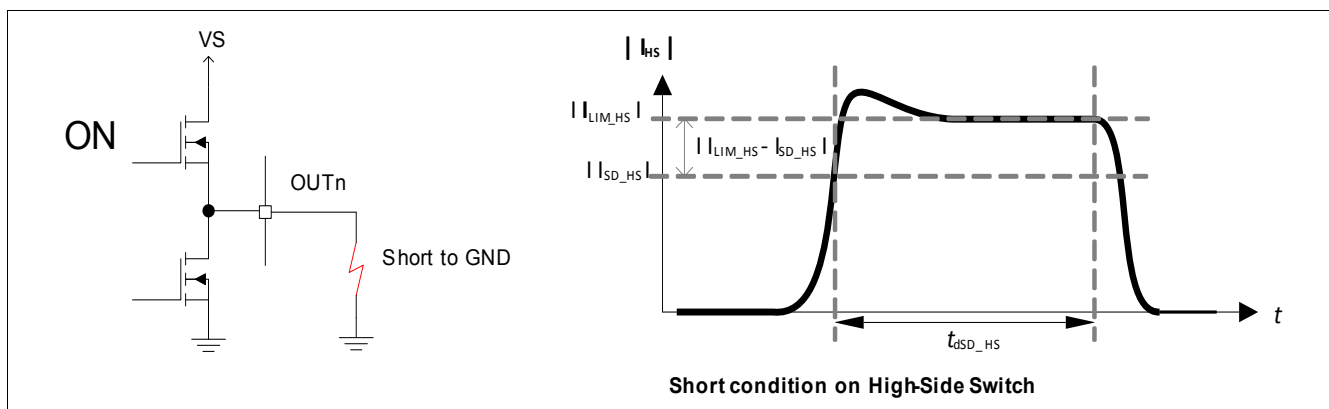

**Figure 6 High-Side Switch - Short Circuit and Overcurrent Protection**

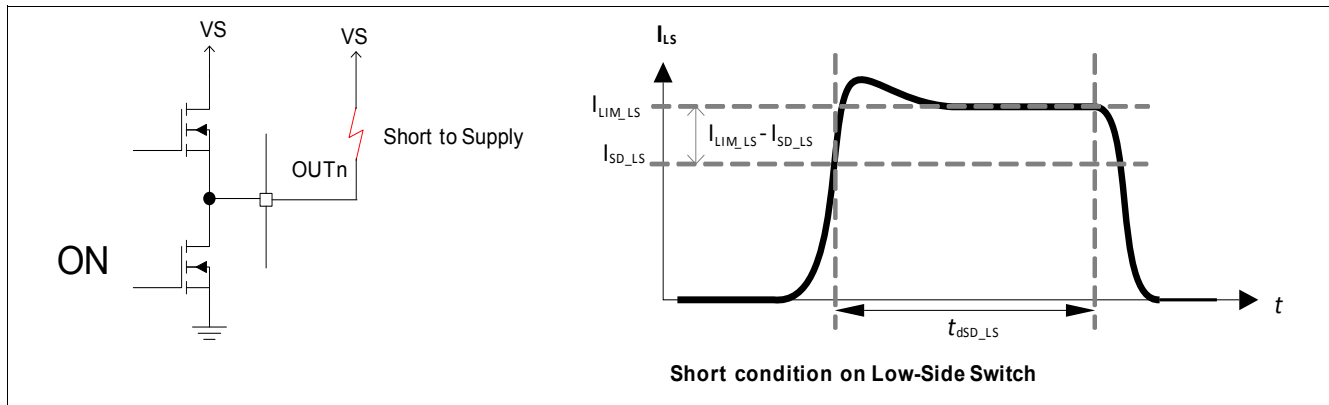

**Figure 7 Low-Side Switch - Short Circuit and Overcurrent Protection**

### 6.3.2 Cross-current protection

In bridge configurations the high-side and low-side power transistors are ensured never to be simultaneously "ON" to avoid cross currents. This is achieved by integrating delays in the driver stage of the power outputs to create a dead-time between switching off of one power transistor and switching on of the adjacent power transistor within the half-bridge. The dead times,  $t_{DHL}$  and  $t_{DLH}$ , as shown in [Figure 8](#) case 3 and [Figure 9](#) case 3, have been specified to ensure that the switching slopes do not overlap with each other. This prevents a cross conduction event.

Half-Bridge Outputs

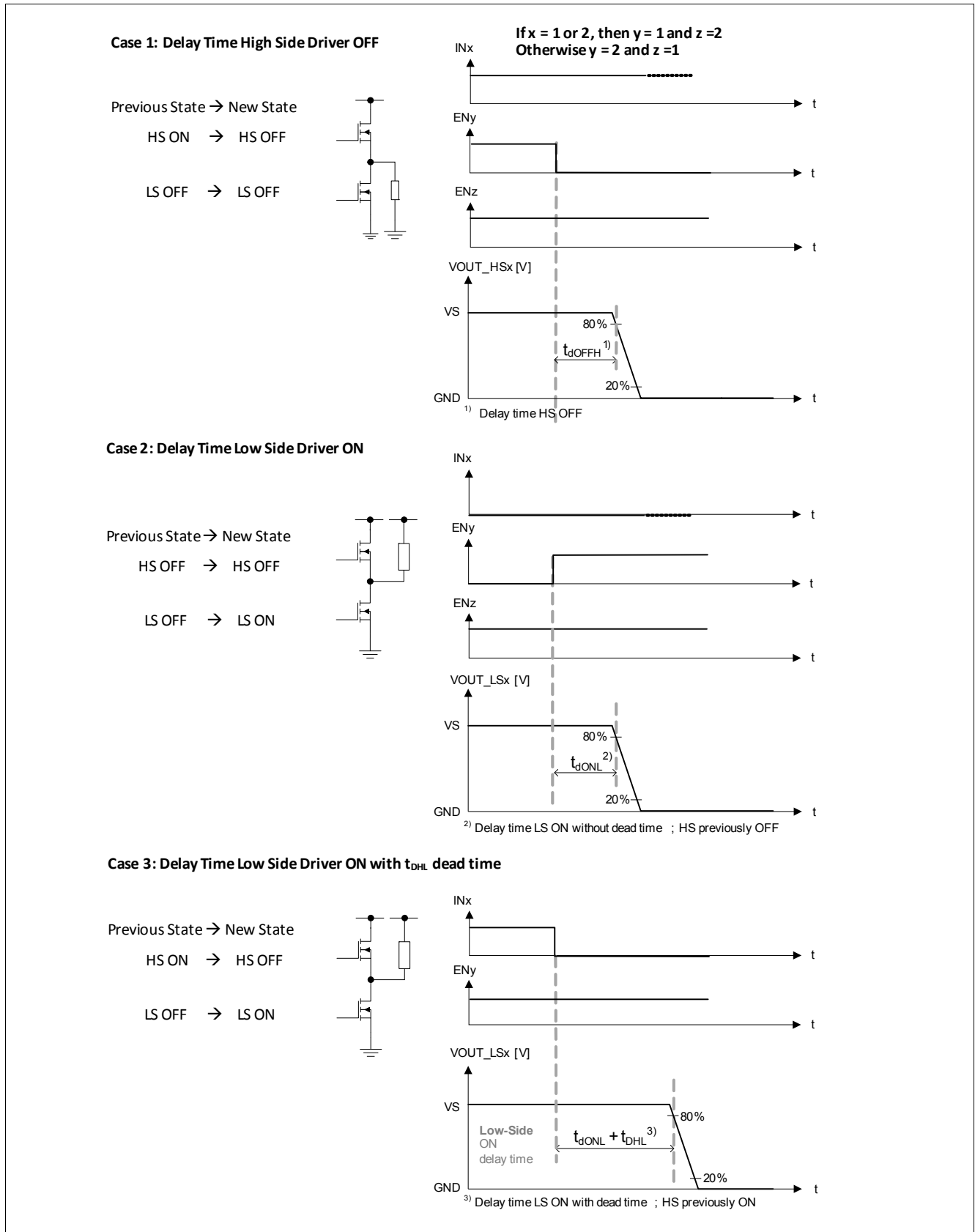

Figure 8 Half bridge outputs switching times - high-side to low-side transition



Half-Bridge Outputs

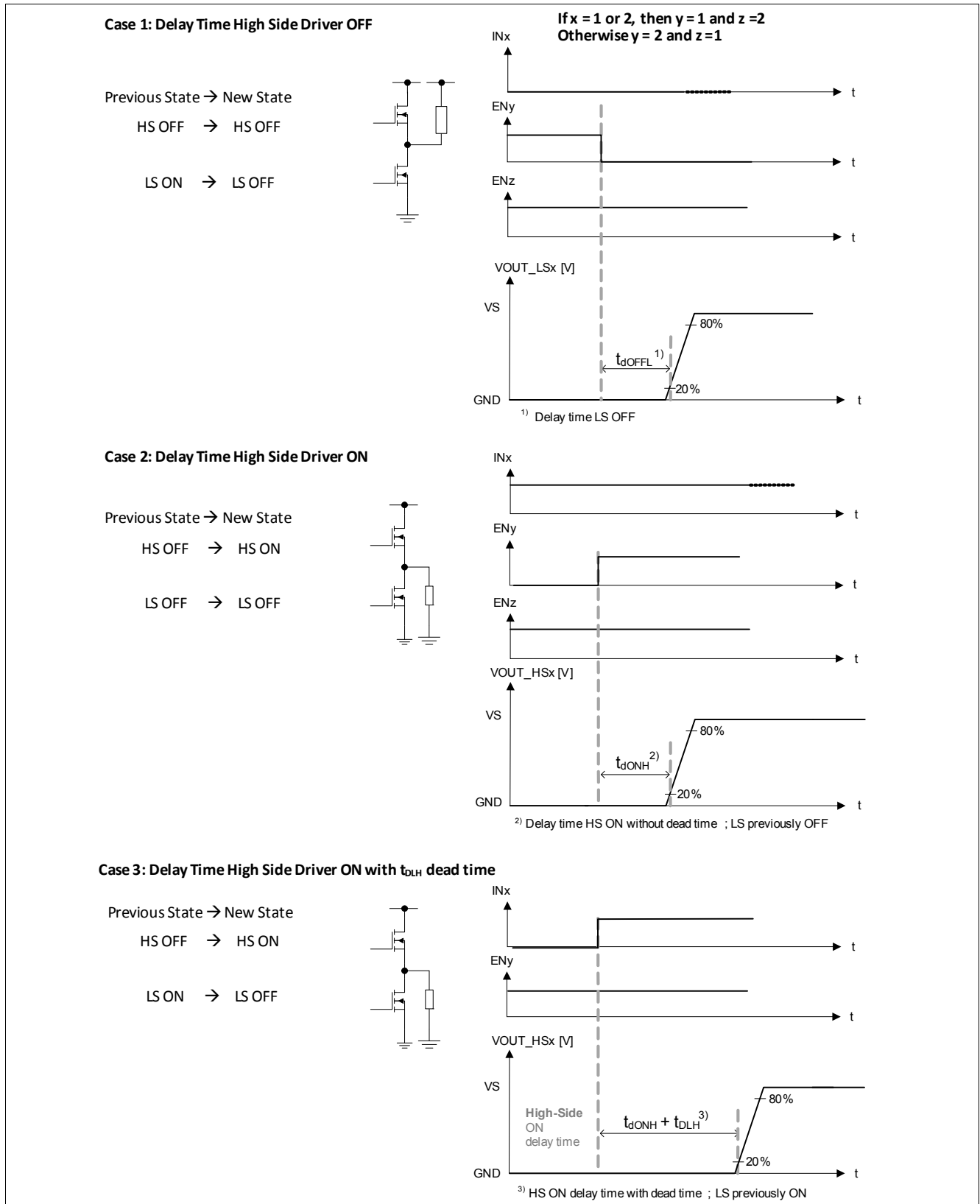

Figure 9 Half bridge outputs switching times- low-side to high-side transition

6.3.3 Temperature monitoring and shutdown

Temperature sensors are integrated in the power stages. The temperature monitoring circuit compares the measured temperature to the shutdown threshold.

## Half-Bridge Outputs

If one or more temperature sensors reach the shut-down temperature threshold, **all outputs are latched off**. All outputs remain deactivated as long as EN1 = 1 or EN2 = 1.

To resume normal functionality of the power switch (in the event the overtemperature condition disappears or to verify if the failure still exists) the microcontroller shall:

1. clear the error flag by setting EN1 and EN2 to 0 (see [Table 10](#))
2. set EN1 or EN2 to 1 in order to send the device from sleep mode back to normal mode

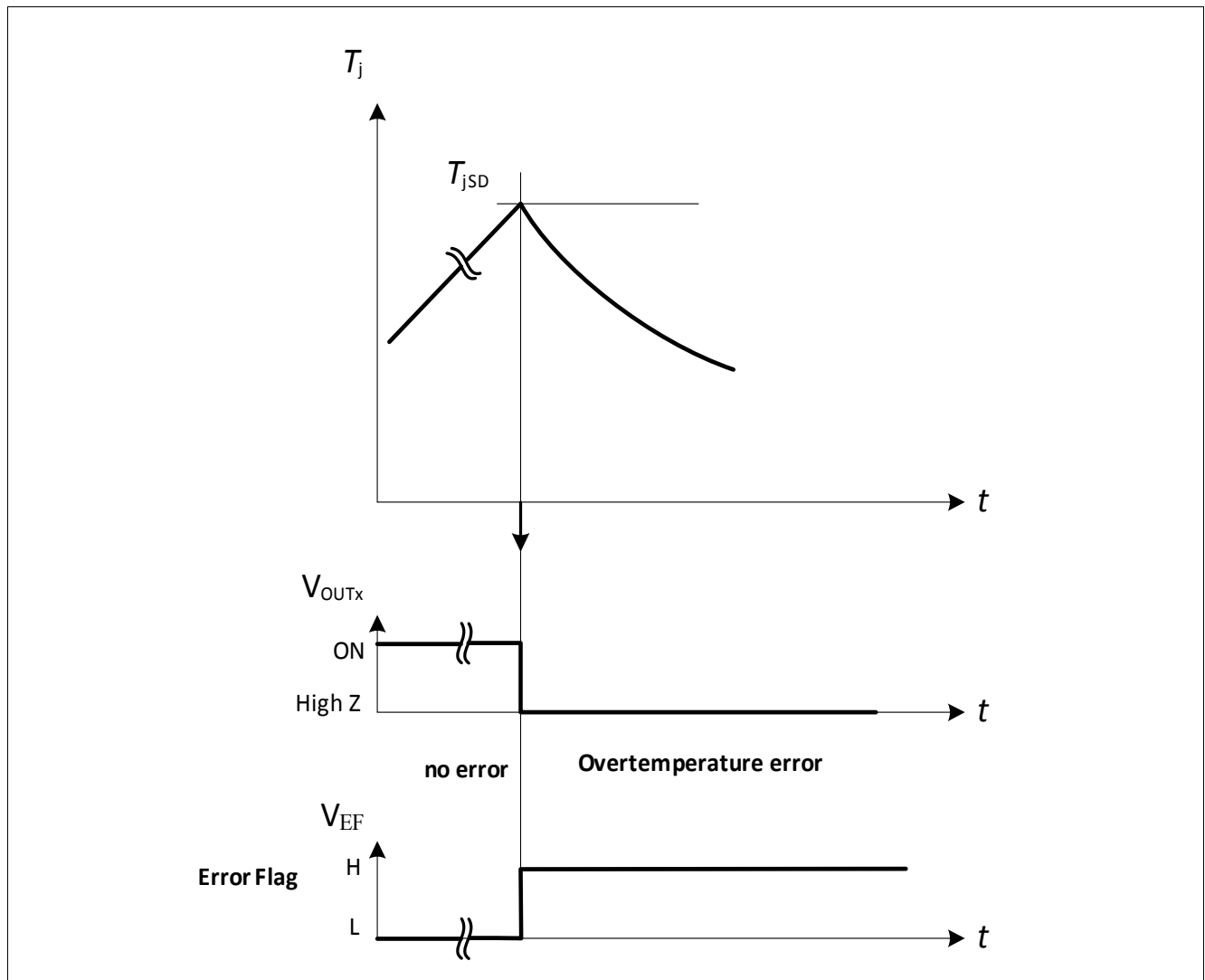

**Figure 10** Overtemperature Behaviour

Half-Bridge Outputs

6.3.4 VS Undervoltage Behaviour

If the supply voltage decreases to the undervoltage switch-off threshold,  $V_{UV\ OFF}$ , then all output switches are switched off, and the error flag EF is set to High (error detection). If  $V_S$  rises again and reaches the undervoltage switch-on threshold,  $V_{UV\ ON}$ , the power-stages are automatically reactivated according to ENx and INx. Refer to **Figure 11**

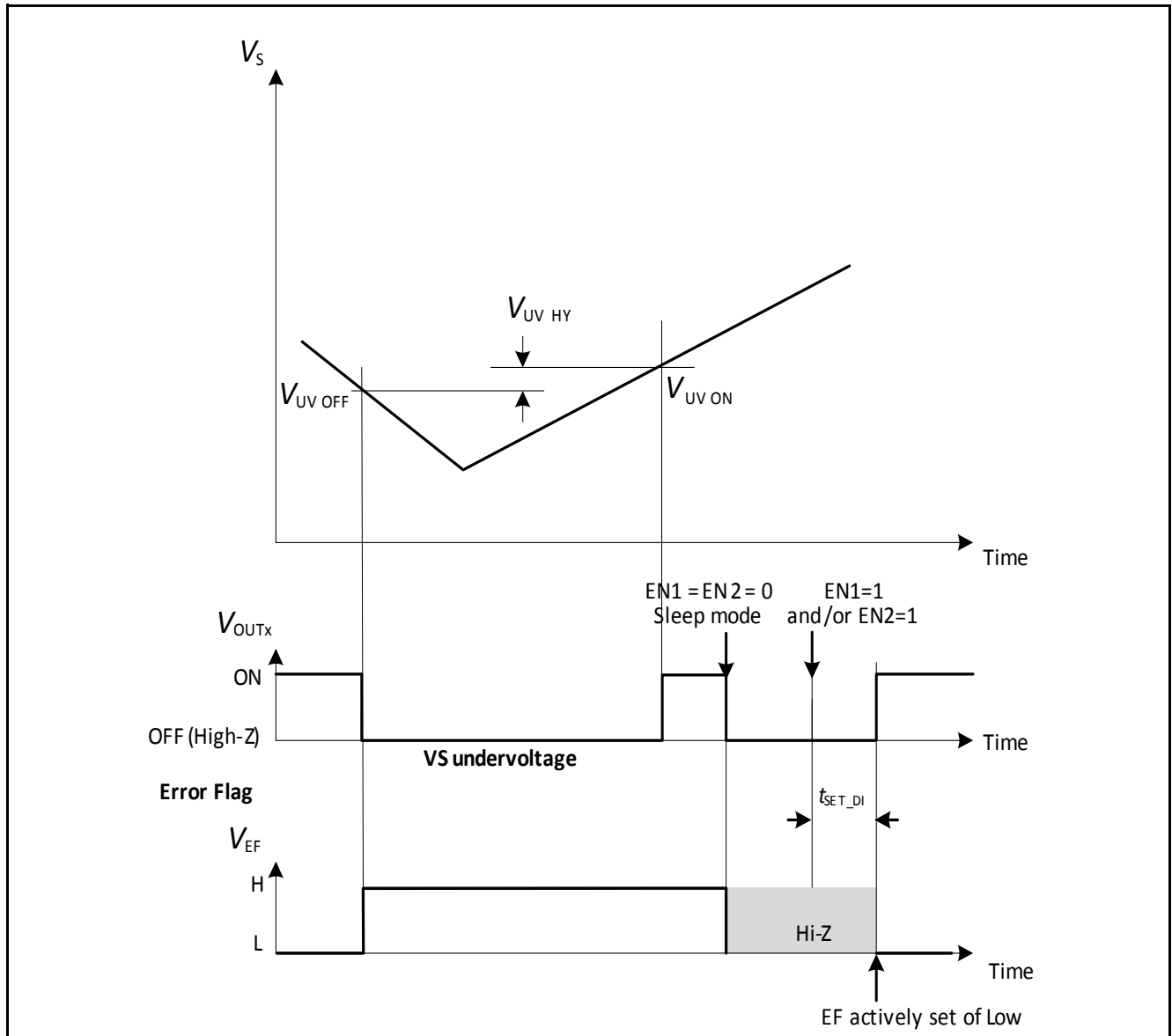

Figure 11 Undervoltage behaviour

Half-Bridge Outputs

6.3.5 VS Overvoltage Behaviour

If the supply voltage increases beyond the overvoltage switch threshold,  $V_{OV\ OFF}$ , then all output switches are switched off and EF is set High, indicating an overvoltage condition. If  $V_S$  decreases again and reaches the overvoltage switch-on threshold,  $V_{OV\ ON}$ , then the power-stages are automatically reactivated according to ENx and INx. Refer to **Figure 12**.

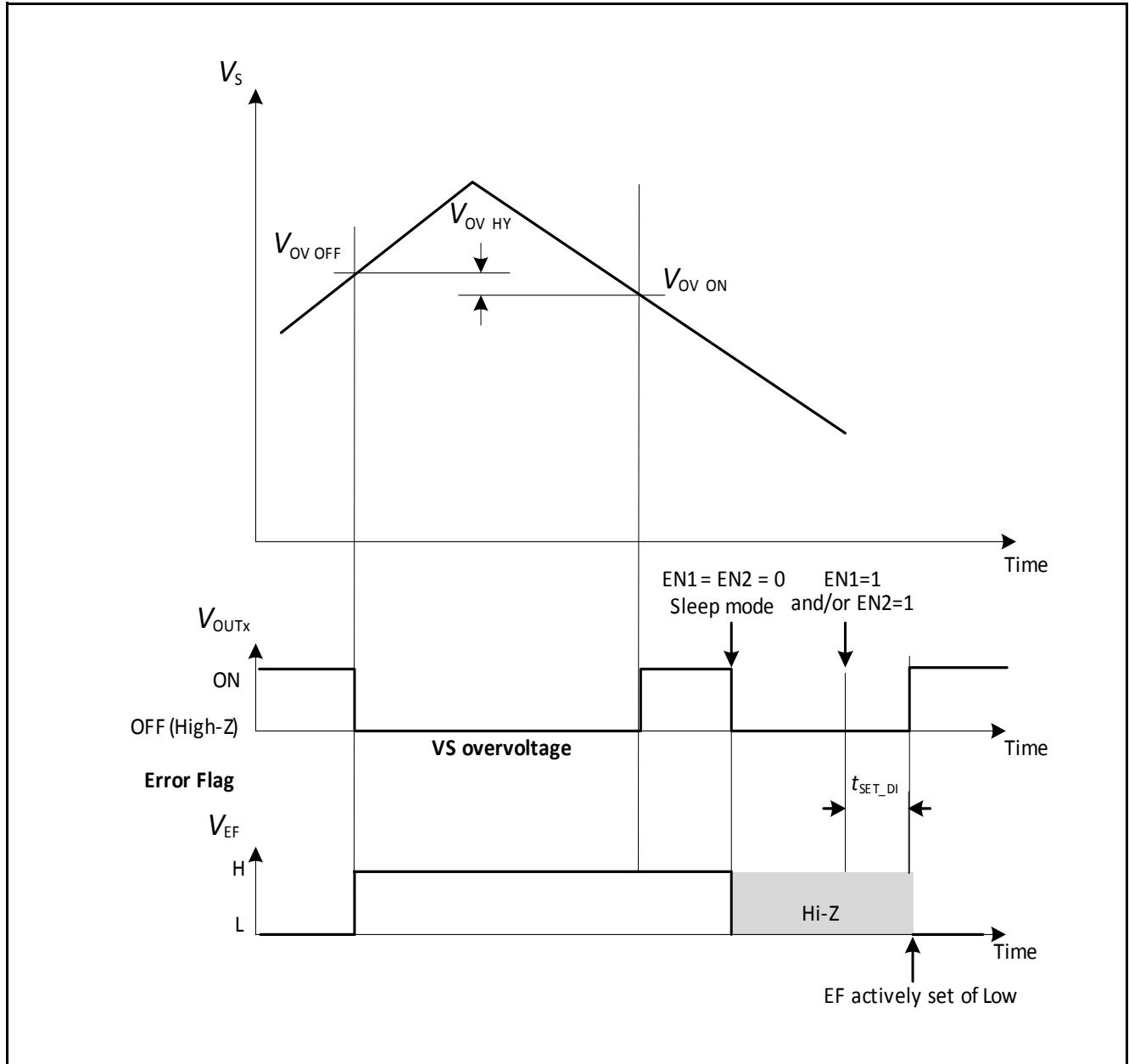

Figure 12 Overvoltage behaviour

6.3.6 V<sub>DD</sub> Undervoltage

In the event the  $V_{DD}$  logic supply decreases below the undervoltage threshold,  $V_{DD\_POFFR}$ , the TLE94004EP will enter reset. EF is set to high impedance during a  $V_{DD}$  undervoltage event.

The digital block will be initialized and the output stages are switched off to High impedance. The undervoltage reset is released once  $V_{DD}$  voltage levels are above the undervoltage threshold,  $V_{DD\ POR}$ .

Application Information

7 Application Information

Note: The following simplified application examples are given as a hint for the implementation of the device only and shall not be regarded as a description or warranty of a certain functionality, condition or quality of the device. The function of the described circuits must be verified in the real application.

7.1 Application Diagram

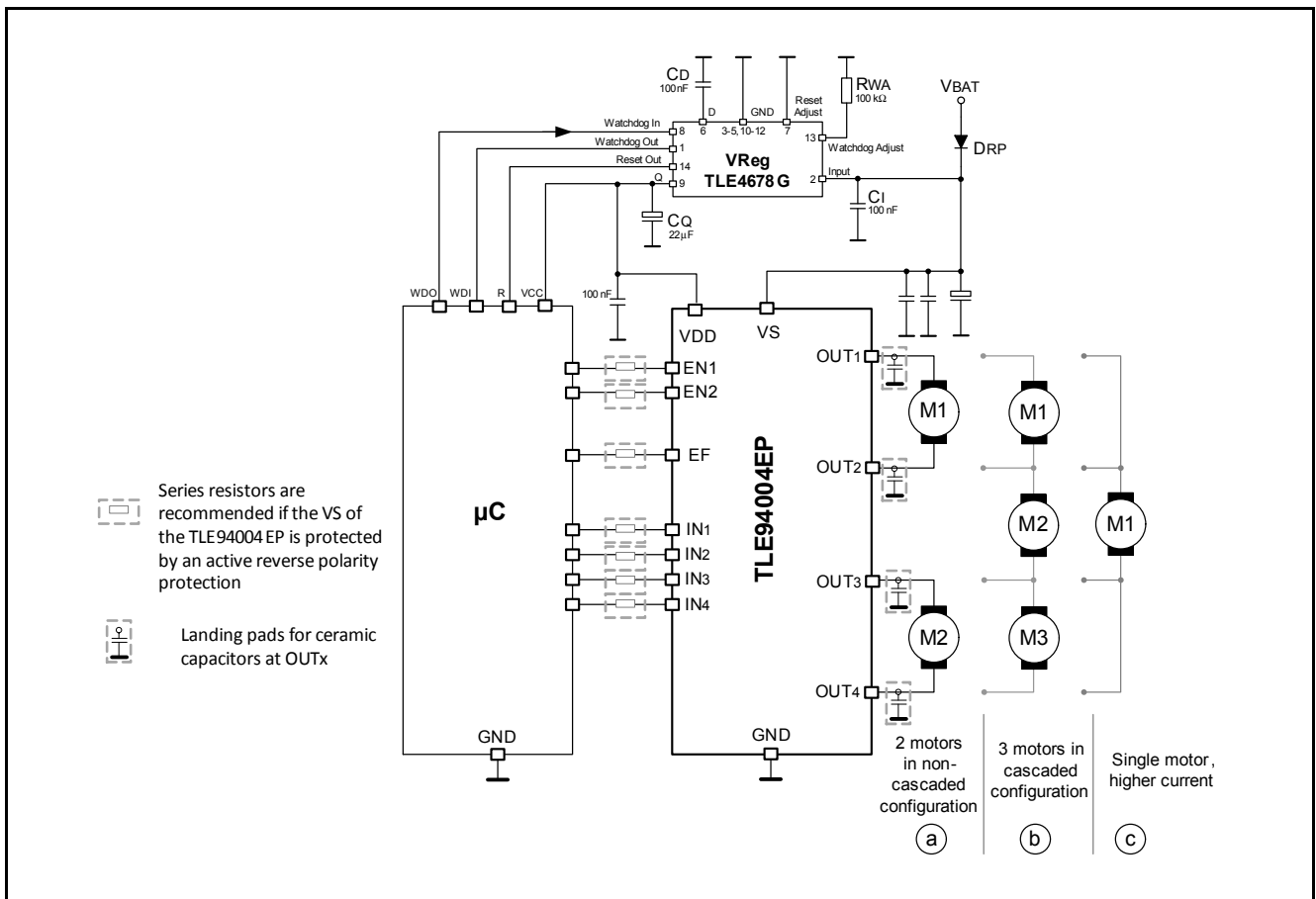

Figure 13 Application Example for DC-motor loads

Application Information

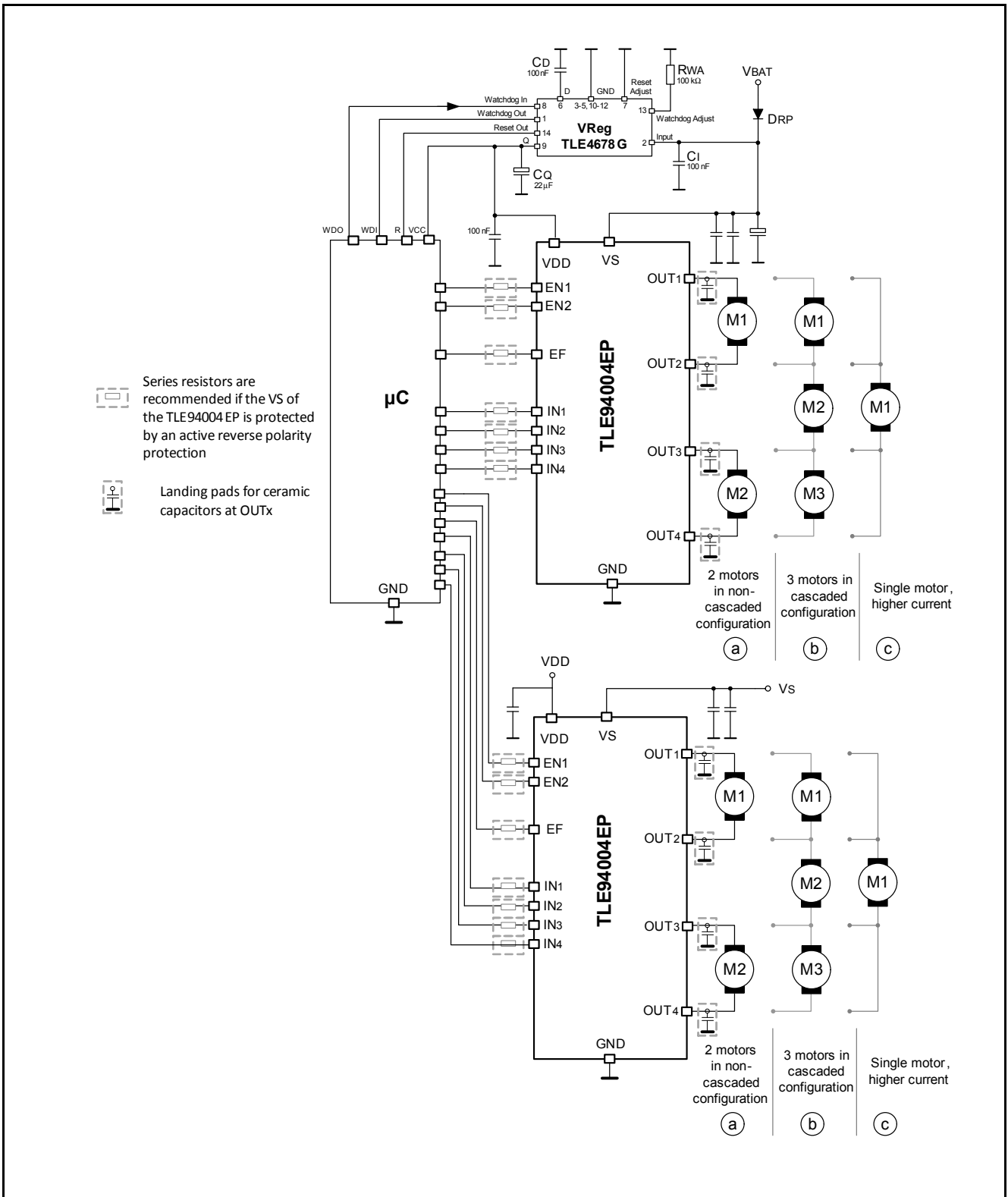

Figure 14 Application Example with two TLE94004EP



Application Information

7.2 Thermal application information

Ta = -40°C, Ch1 to Ch4 are dissipating a total of 0.8W (0.2W each).

Ta = 85°C, Ch1 to Ch4 are dissipating a total of 0.54W (0.135W each).

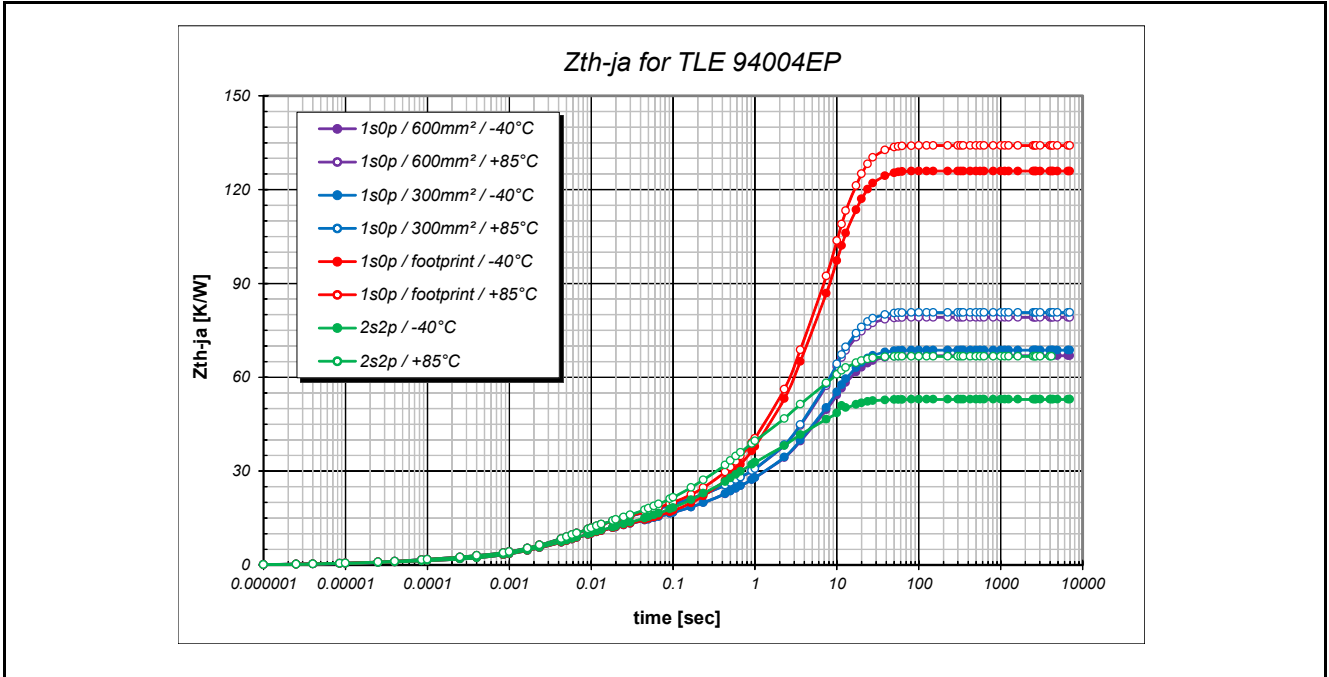

Figure 16 ZthJA Curve for different PCB setups

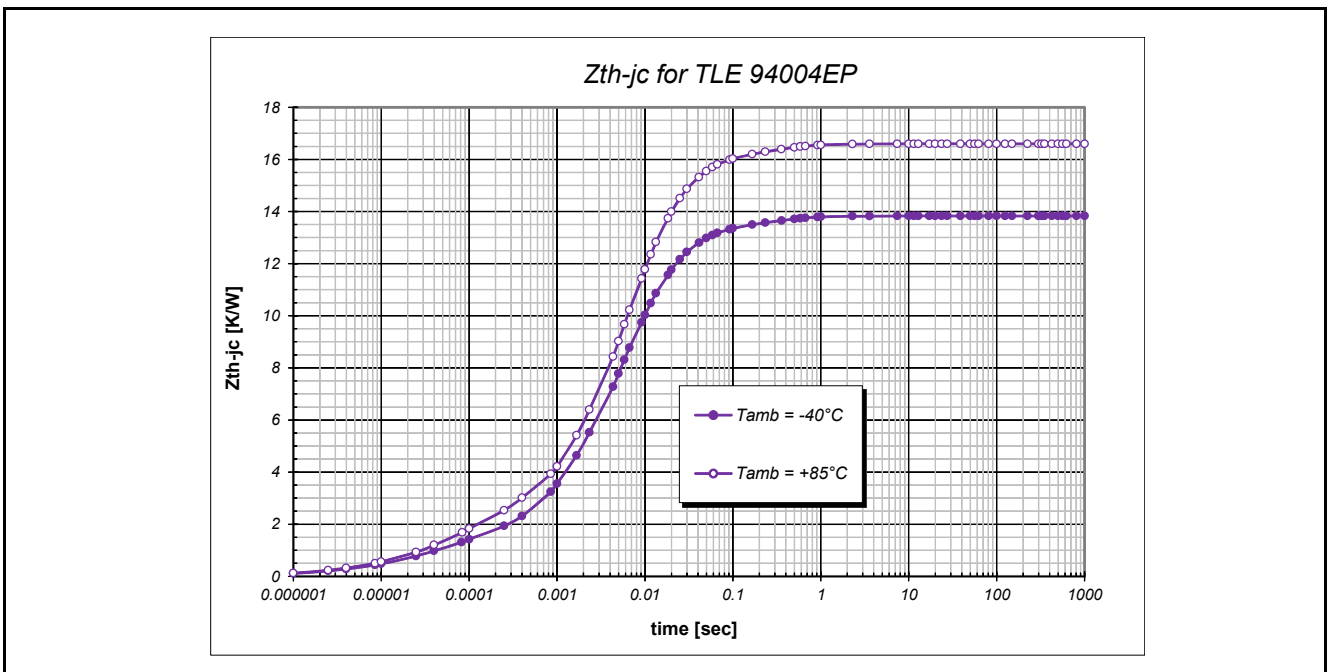

Figure 17 ZthJC Curve



Package Outlines

8 Package Outlines

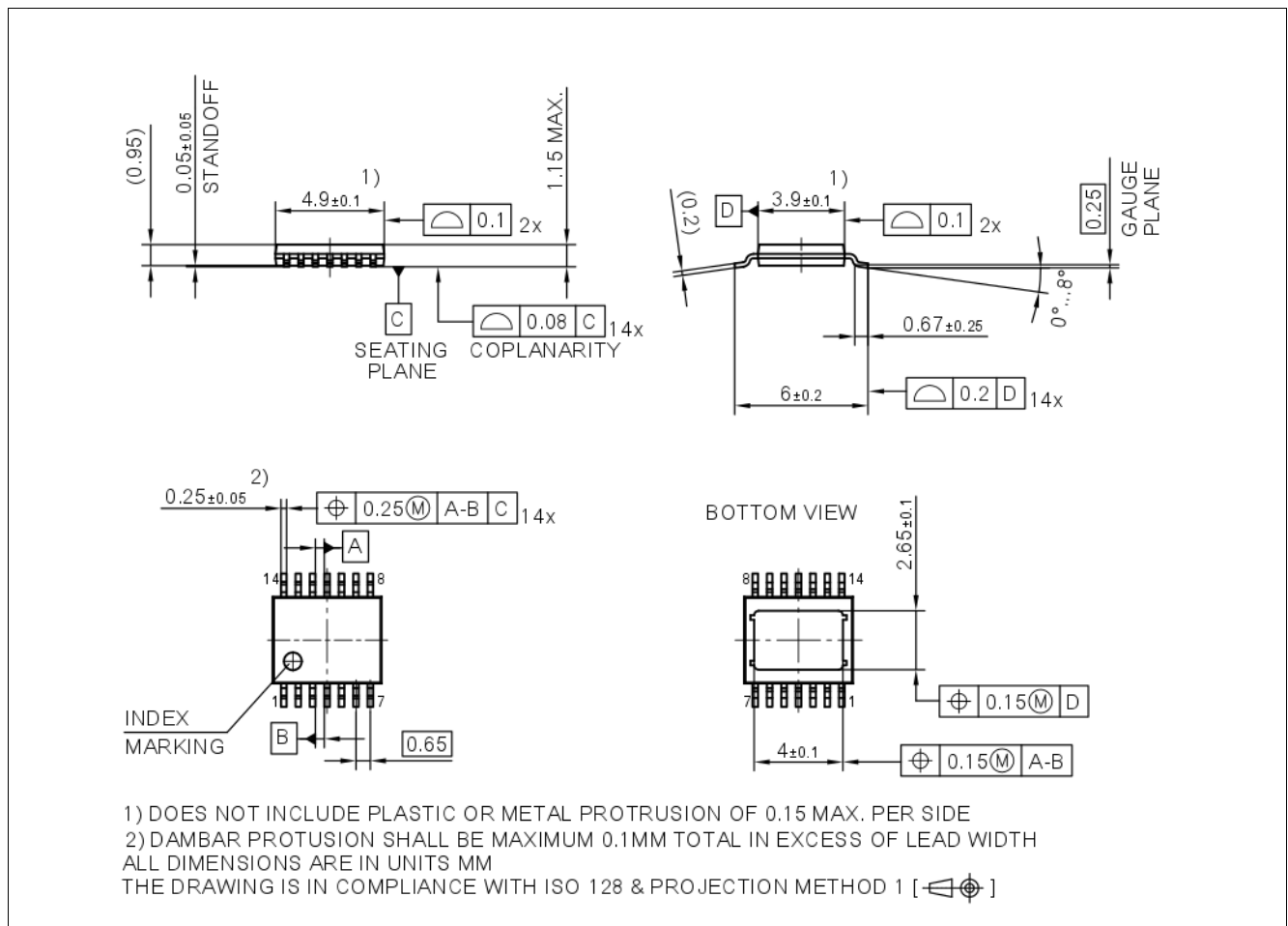

Figure 18 PG-TSDSO-14 (Plastic Green - Dual Small Outline Package)

Green Product (RoHS compliant)

To meet the world-wide customer requirements for environmentally friendly products and to be compliant with government regulations the device is available as a green product. Green products are RoHS-Compliant (i.e lead-free finish on leads and suitable for Pb-free soldering according to IPC/JEDEC J-STD-020).

For further information on alternative packages, please visit our website:  
<http://www.infineon.com/packages>.

Dimensions in mm

---

**Revision History****9 Revision History**

<b>Revision</b>	<b>Date</b>	<b>Changes</b>
1.0	2017-12-07	Initial release

## Trademarks

All referenced product or service names and trademarks are the property of their respective owners.

**Edition 2017-12-07**

**Published by**

**Infineon Technologies AG**

**81726 Munich, Germany**

**© 2017 Infineon Technologies AG.**

**All Rights Reserved.**

**Do you have a question about any aspect of this document?**

**Email: [erratum@infineon.com](mailto:erratum@infineon.com)**

**Document reference**

**Doc\_Number**

## IMPORTANT NOTICE

The information given in this document shall in no event be regarded as a guarantee of conditions or characteristics ("Beschaffheitsgarantie").

With respect to any examples, hints or any typical values stated herein and/or any information regarding the application of the product, Infineon Technologies hereby disclaims any and all warranties and liabilities of any kind, including without limitation warranties of non-infringement of intellectual property rights of any third party.

In addition, any information given in this document is subject to customer's compliance with its obligations stated in this document and any applicable legal requirements, norms and standards concerning customer's products and any use of the product of Infineon Technologies in customer's applications.

The data contained in this document is exclusively intended for technically trained staff. It is the responsibility of customer's technical departments to evaluate the suitability of the product for the intended application and the completeness of the product information given in this document with respect to such application.

For further information on technology, delivery terms and conditions and prices, please contact the nearest Infineon Technologies Office ([www.infineon.com](http://www.infineon.com)).

## WARNINGS

Due to technical requirements products may contain dangerous substances. For information on the types in question please contact your nearest Infineon Technologies office.

Except as otherwise explicitly approved by Infineon Technologies in a written document signed by authorized representatives of Infineon Technologies, Infineon Technologies' products may not be used in any applications where a failure of the product or any consequences of the use thereof can reasonably be expected to result in personal injury.