



# TSA50N20MK

## 200V N-Channel MOSFET

### General Description

This Power MOSFET is produced using Truesemi's advanced planar stripe DMOS technology. This advanced technology has been especially tailored to minimize on-state resistance, provide superior switching performance, and withstand high energy pulse in the avalanche and commutation mode. These devices are well suited for high efficiency switched mode power supplies, active power factor correction based on half bridge topology.

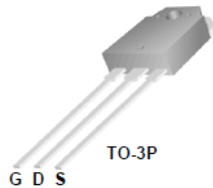

### Features

- 50A, 200V, Max.  $R_{DS(on)} = 0.038\Omega$  @  $V_{GS} = 10V$
- Low gate charge
- High ruggedness
- Fast switching
- 100% avalanche tested
- Improved dv/dt capability

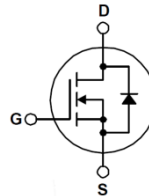

### Absolute Maximum Ratings $T_J = 25^\circ C$ unless otherwise specified

Absolute Maximum Ratings $T_C = 25^\circ C$ , unless otherwise noted			
Parameter	Symbol	Value	Unit
Drain-Source Voltage (note1)	$V_{DSS}$	200	V
Continuous Drain Current	$I_D$	50	A
Pulsed Drain Current (note2)	$I_{DM}$	200	
Gate-Source Voltage	$V_{GSS}$	$\pm 20$	V
Single Pulse Avalanche Energy (note2)	$E_{AS}$	400	mJ
Power Dissipation ( $T_C = 25^\circ C$ )	$P_D$	34	W/ $^\circ C$
Operating Junction and Storage Temperature Range	$T_J, T_{stg}$	-55~+150	

### Thermal Resistance Characteristics

Thermal Resistance			
Parameter	Symbol	Value	Unit
Thermal Resistance, Junction-to-Case	$R_{thJC}$	0.5	$^\circ C/W$
Thermal Resistance, Junction-to-Ambient	$R_{thJA}$	45	

## Electrical Characteristics $T_J=25^\circ\text{C}$ unless otherwise specified

Specifications $T_J = 25^\circ\text{C}$ , unless otherwise noted						
Parameter	Symbol	Test Conditions	Value			Unit
			Min.	Typ.	Max.	
<b>Static</b>						
Drain-Source Breakdown Voltage	$V_{(BR)DSS}$	$V_{GS} = 0V, I_D = 250\mu\text{A}$	200	--	--	V
Zero Gate Voltage Drain Current	$I_{DSS}$	$V_{DS} = 200V, V_{GS} = 0V, T_J = 25^\circ\text{C}$	--	--	1	$\mu\text{A}$
Gate-Source Leakage	$I_{GSS}$	$V_{GS} = \pm 20V, V_{DS} = 0V$	--	--	$\pm 100$	nA
Gate-Source Threshold Voltage	$V_{GS(th)}$	$V_{DS} = V_{GS}, I_D = 250\mu\text{A}$	2	--	4	V
Drain-Source On-Resistance (Note4)	$R_{DS(on)}$	$V_{GS} = 10V, I_D = 25A$	--	0.030	0.038	$\Omega$
<b>Dynamic</b>						
Input Capacitance	$C_{iss}$	$V_{GS} = 0V,$ $V_{DS} = 25V,$ $f = 1.0\text{MHz}$	--	3538	--	pF
Output Capacitance	$C_{oss}$		--	657	--	
Reverse Transfer Capacitance	$C_{rss}$		--	280	--	
Total Gate Charge	$Q_g$	$V_{DD} = 160V, I_D = 50A,$ $V_{GS} 0 \text{ to } 10V$	--	244	--	nC
Gate-Source Charge	$Q_{gs}$		--	16	--	
Gate-Drain Charge	$Q_{gd}$		--	144	--	
Turn-on Delay Time	$t_{d(on)}$	$V_{DD} = 100V, I_D = 50A,$ $V_{GS} = 10V, R_G = 25\Omega$	--	53	--	ns
Turn-on Rise Time	$t_r$		--	65	--	
Turn-off Delay Time	$t_{d(off)}$		--	689	--	
Turn-off Fall Time	$t_f$		--	230	--	
<b>Drain-Source Body Diode Characteristics</b>						
Continuous Source Current	$I_{SD}$	Integral PN-diode in MOSFET	--	--	50	A
Pulsed Source Current	$I_{SM}$		--	--	200	
Body Forward Voltage	$V_{SD}$	$I_S = 20A, V_{GS} = 0V$	--	--	1.5	V
Reverse Recovery Time	$t_{rr}$	$V_{GS} = 0V, I_F = 10A,$ $di_F/dt = 100A/\mu\text{s}$	--	208	--	ns
Reverse Recovery Charge	$Q_{rr}$		--	2.04	--	$\mu\text{C}$

### NOTES:

1. Repetitive Rating: Pulse width limited by maximum junction temperature
2.  $L = 10\text{mH}, V_{DD} = 50V, R_G = 25\Omega$ , Starting  $T_J = 25^\circ\text{C}$
3. Pulse Test: Pulse width  $\leq 300\mu\text{s}$ , Duty Cycle  $\leq 1\%$

**Typical Characteristics**  $T_J = 25^\circ\text{C}$ , unless otherwise noted

**Figure 1. Output Characteristics ( $T_J = 25^\circ\text{C}$ )**

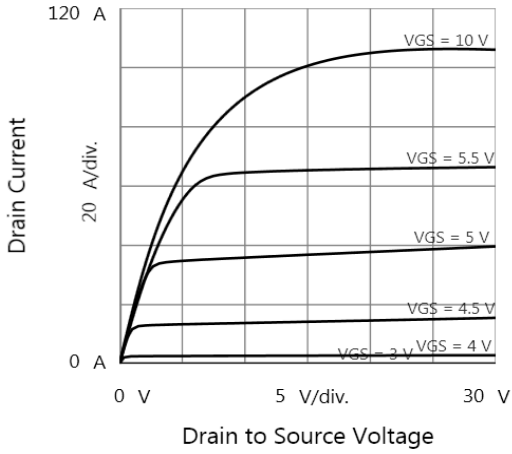

**Figure 2. Transfer Characteristics**

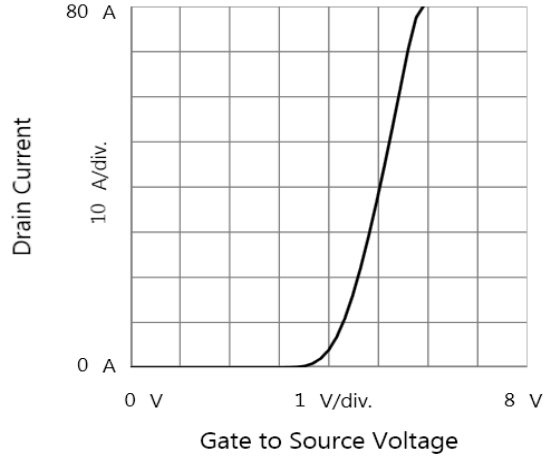

**Figure 3. Drain to Source Resistance vs. Drain Current**

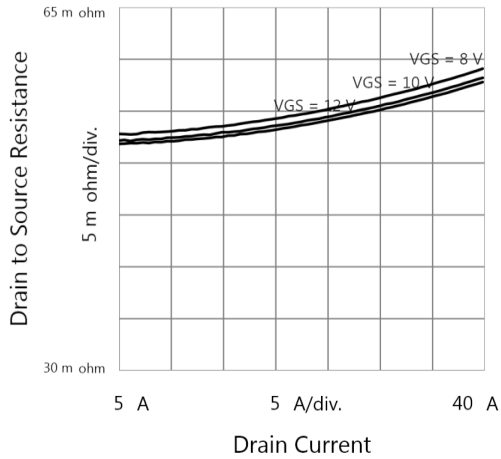

**Figure 4. Drain to Source Resistance vs. Gate to Source Voltage**

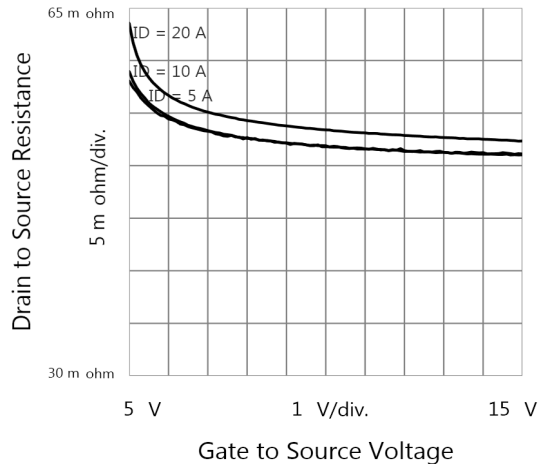

**Figure 5. Drain to Source Voltage vs. Gate to Source Voltage**

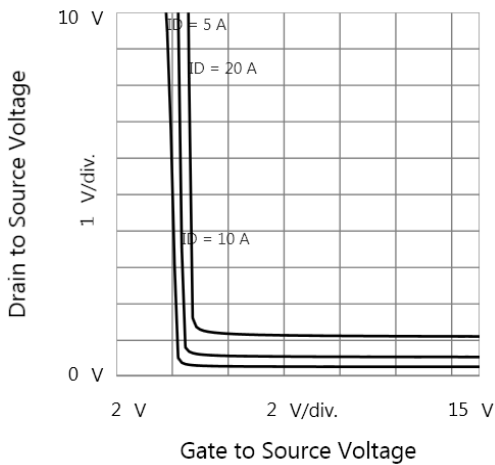

**Figure 6. Body Diode Forward Characteristics**

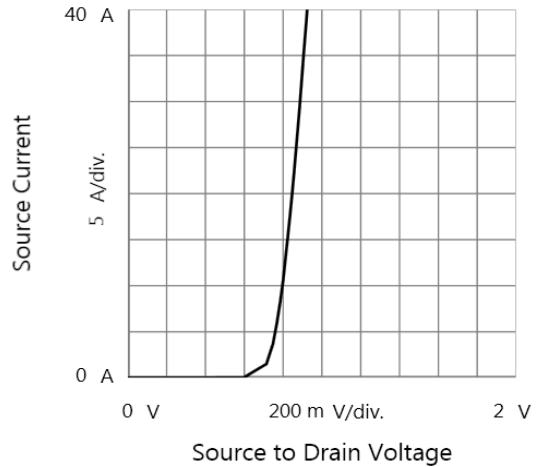

Typical Characteristics  $T_J = 25^\circ\text{C}$ , unless otherwise noted

Figure 7. Capacitance

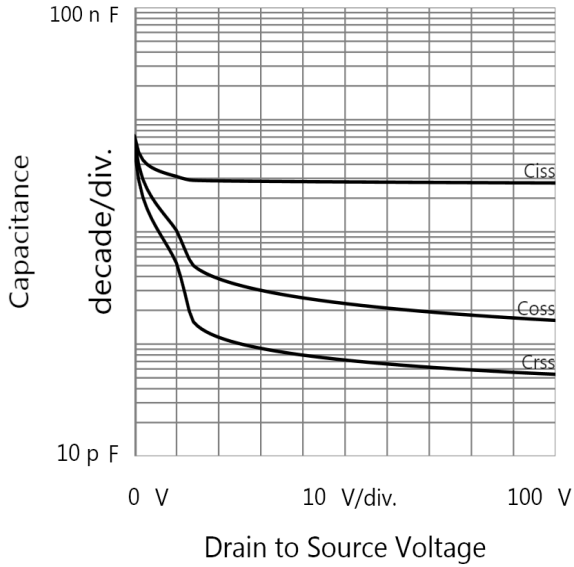

Figure 8. Gate Charge

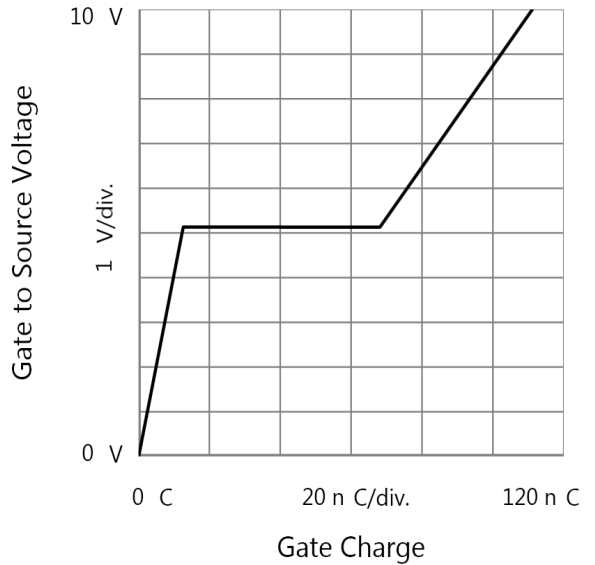

Figure 9. Transient Thermal Impedance TO-220F

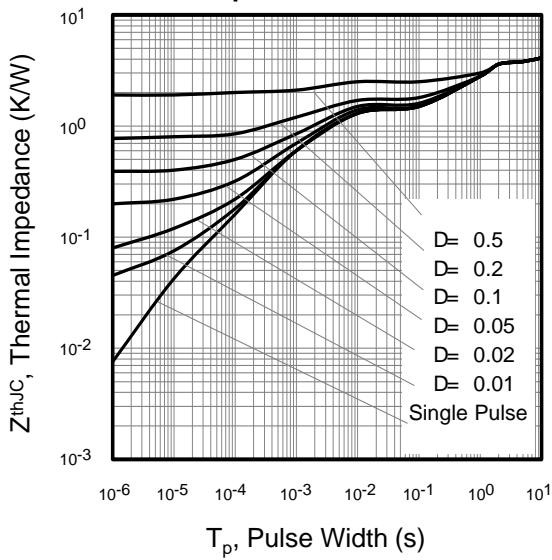
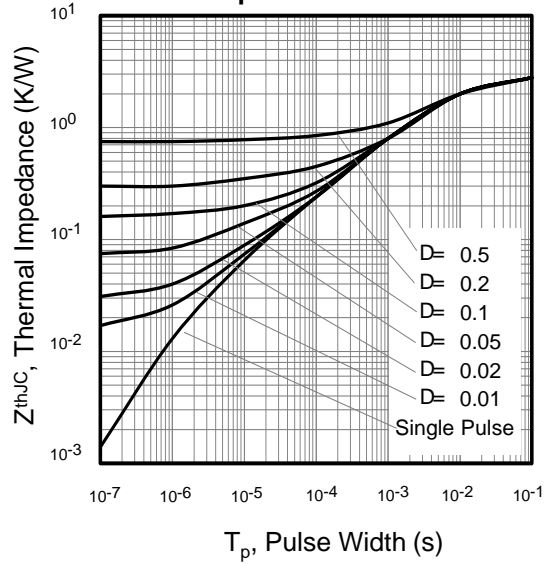

Figure 10. Transient Thermal Impedance TO-220



Typical Characteristics  $T_J = 25^\circ\text{C}$ , unless otherwise noted

Figure 1. Maximum Effective Thermal Impedance, Junction-to-Case

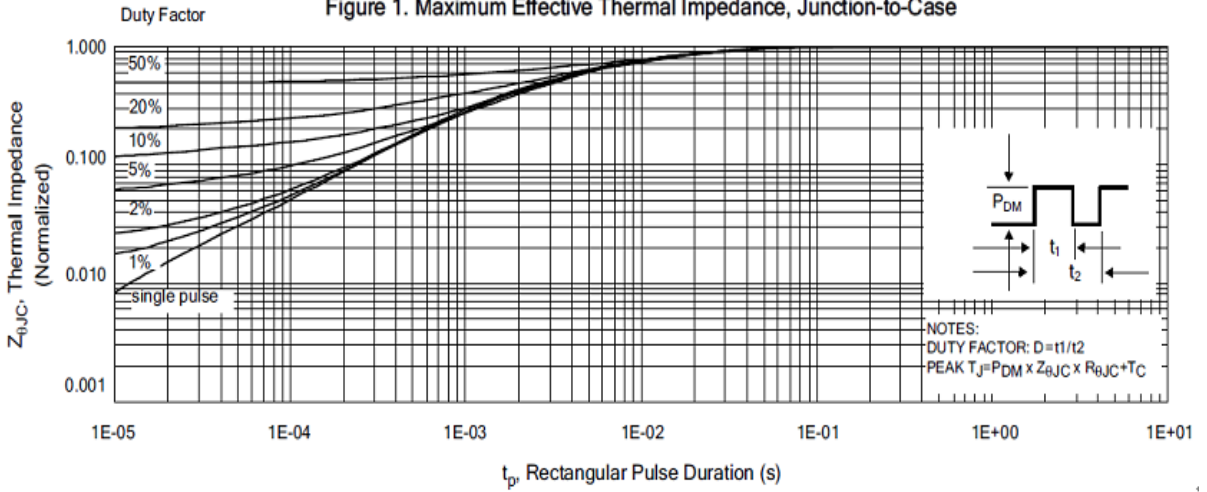

Figure 2. Maximum Power Dissipation vs Case Temperature

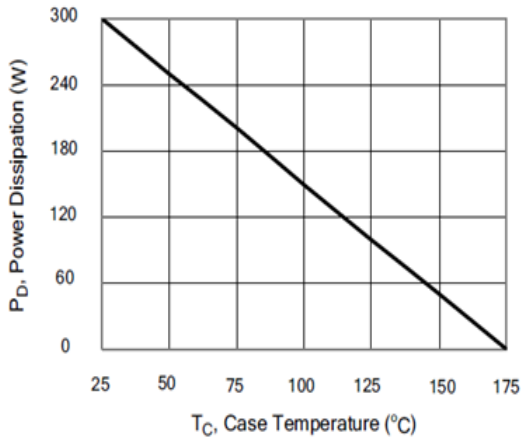

Figure 3. Maximum Continuous Drain Current vs Case Temperature

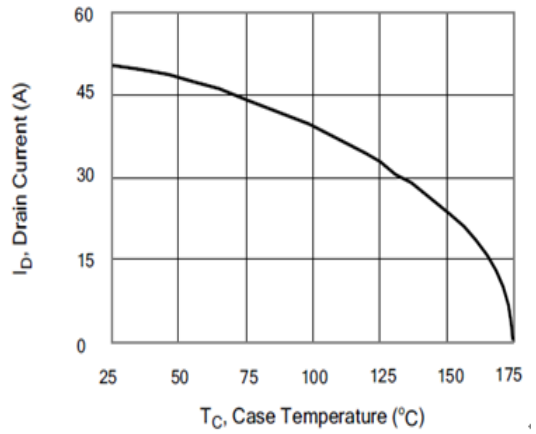

Figure 4. Typical Output Characteristics

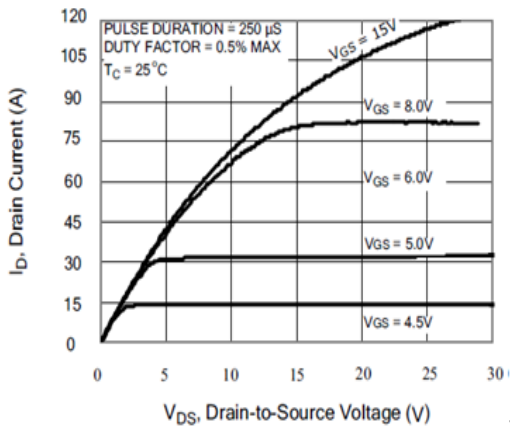
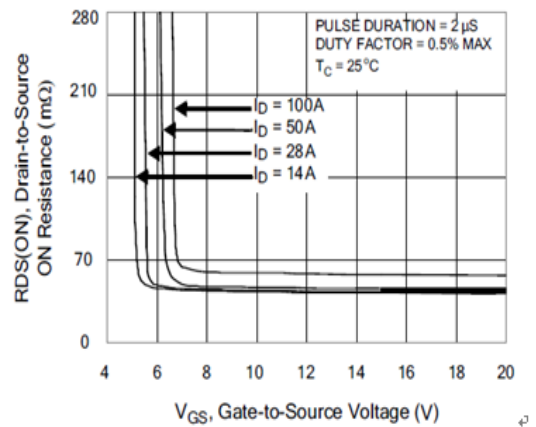

Figure 5. Typical Drain-to-Source ON Resistance vs Gate Voltage and Drain Current



Typical Characteristics  $T_J = 25^\circ\text{C}$ , unless

Figure 6. Maximum Peak Current Capability

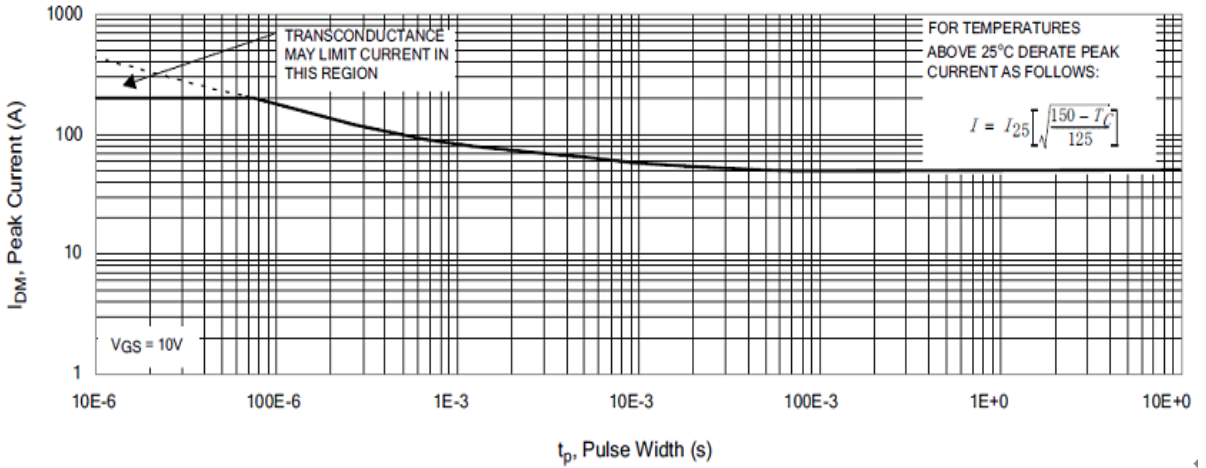

Figure 7. Typical Transfer Characteristics

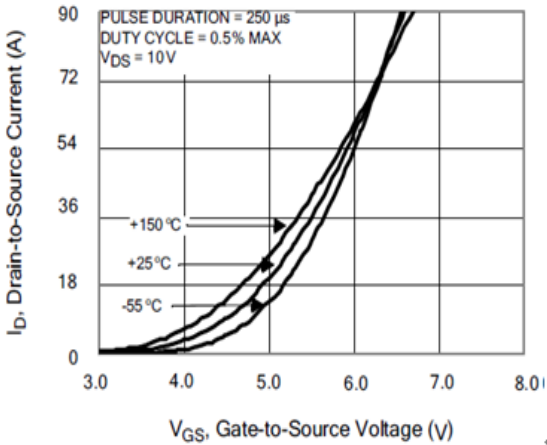

Figure 8. Unclamped Inductive Switching Capability

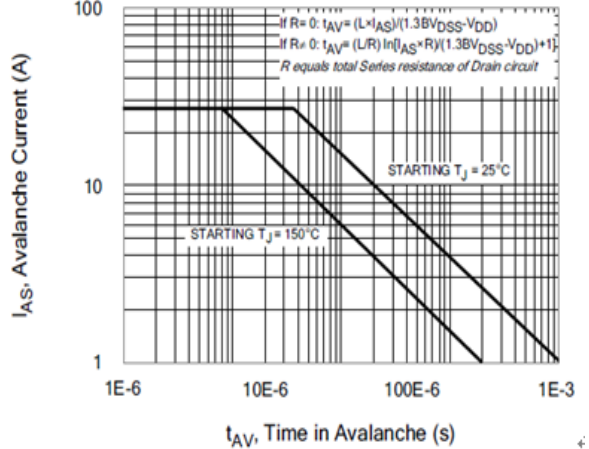

Figure 9. Typical Drain-to-Source ON Resistance vs Drain Current

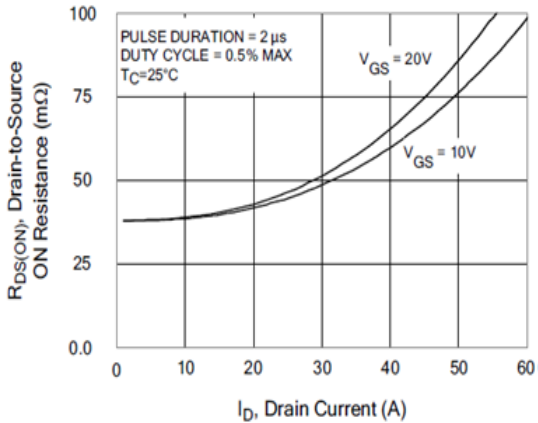

Figure 10. Typical Drain-to-Source ON Resistance vs Junction Temperature

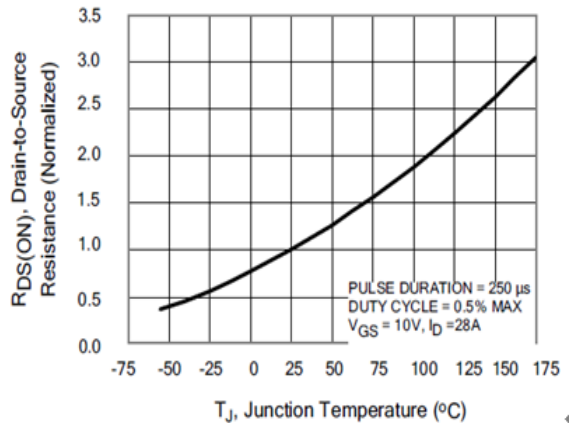

Figure 11. Typical Breakdown Voltage vs Junction Temperature

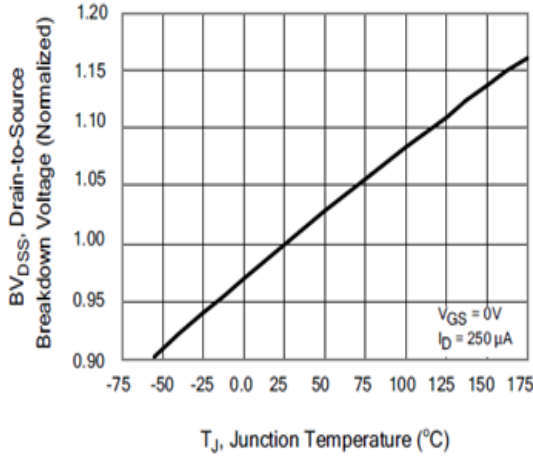

Figure 12. Typical Threshold Voltage vs Junction Temperature

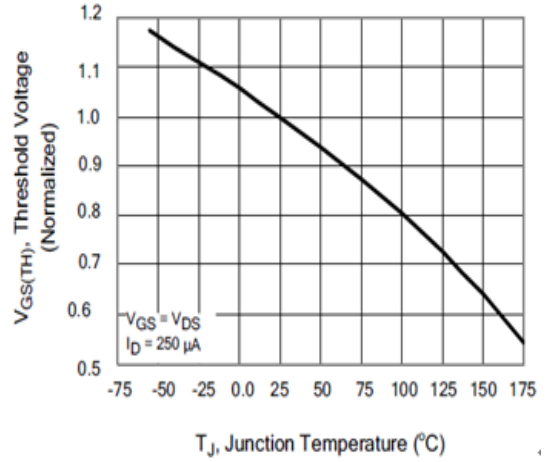

Figure 13. Maximum Forward Bias Safe Operating Area

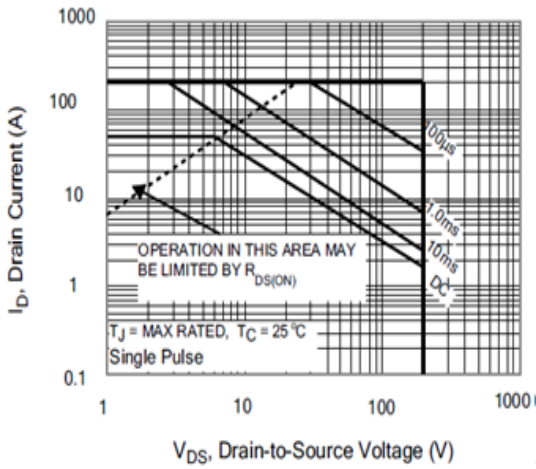

Figure 14. Capacitance vs Vds

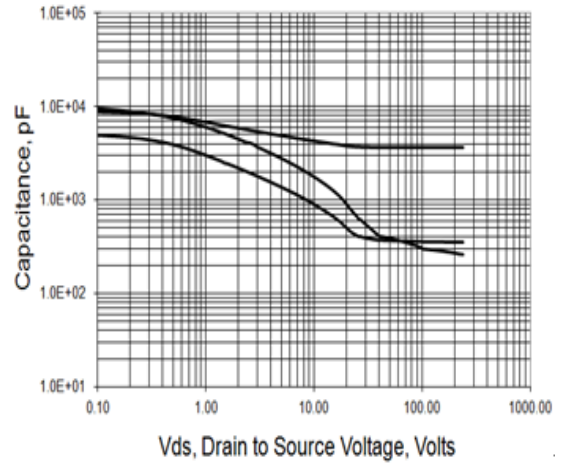

Figure 15. Typical Gate Charge

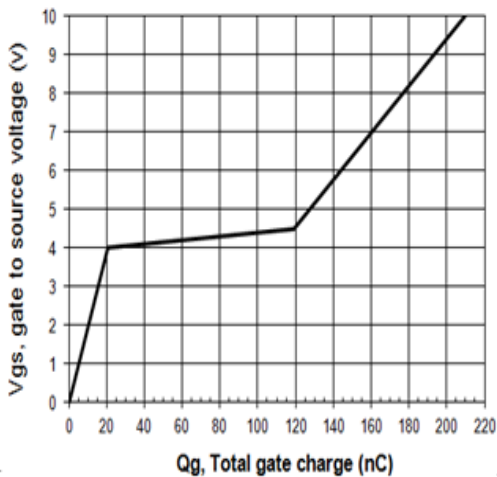
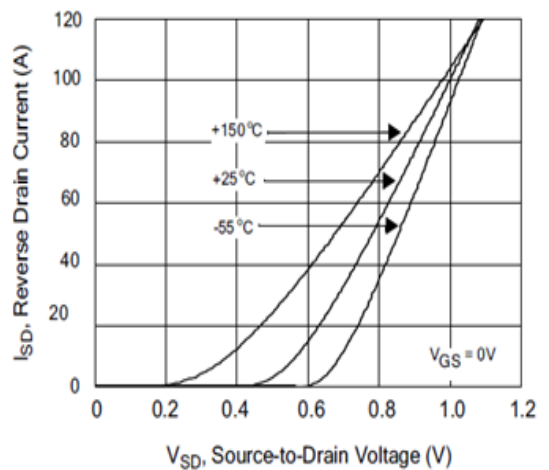
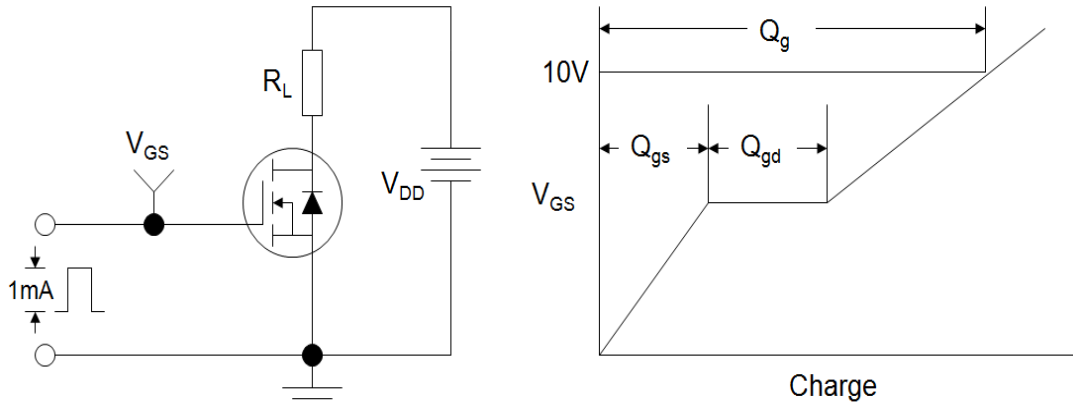

Figure 16. Typical Body Diode Transfer Characteristics



**Figure A: Gate Charge Test Circuit and**



**Figure B: Resistive Switching Test Circuit and Waveform**

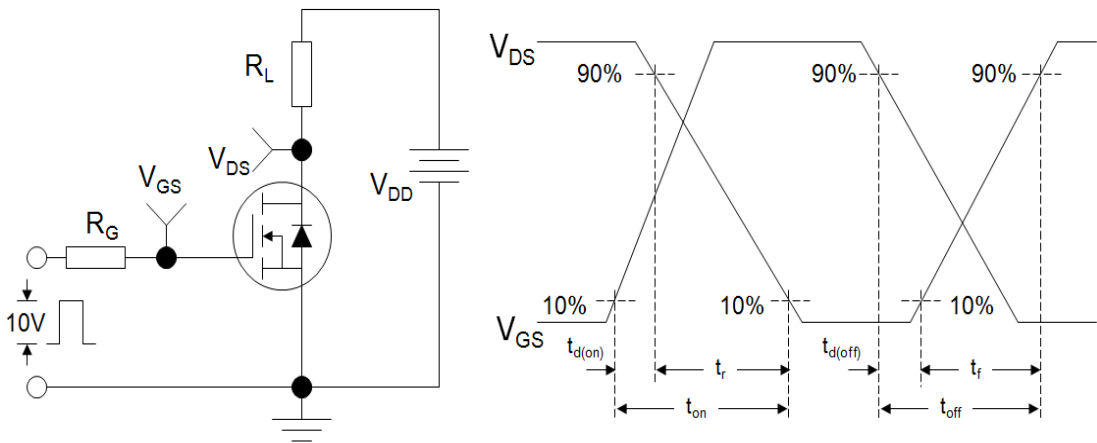

**Figure C: Unclamped Inductive Switching Test Circuit and Waveform**

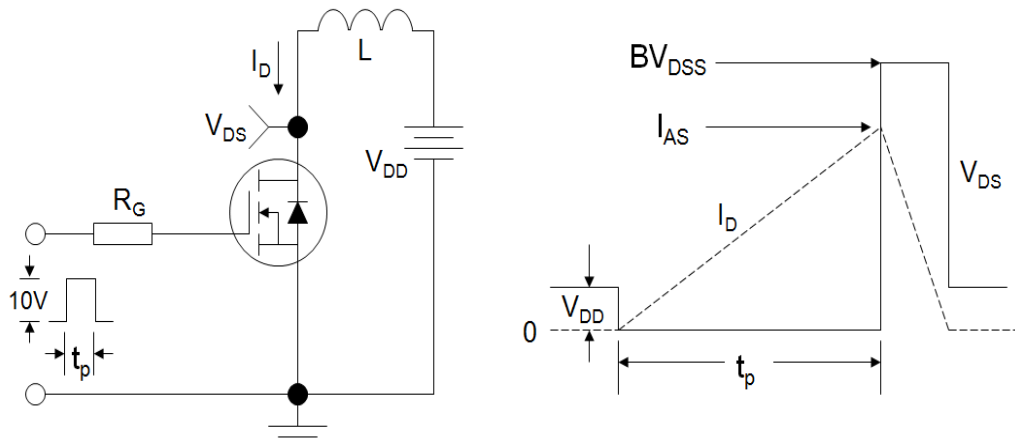



## Disclaimer

All product specifications and data are subject to change without notice.

For documents and material available from this datasheet, Truesemi Semiconductor does not warrant or assume any legal liability or responsibility for the accuracy, completeness of any product or technology disclosed hereunder.

No license, express or implied, by estoppels or otherwise, to any intellectual property rights is granted by this document or by any conduct of Truesemi Semiconductor.

The products shown herein are not designed for use in medical, life-saving, or life-sustaining applications unless. Customers using or selling Truesemi Semiconductor products not expressly indicated for use in such applications do so entirely at their own risk and agree to fully indemnify Truesemi Semiconductor for any damages arising or resulting from such use or sale.

Truesemi Semiconductor disclaims any and all liability arising out of the use or application of any product described herein or of any information provided herein to the maximum extent permitted by law. The product specifications do not expand or otherwise modify Truesemi Semiconductor terms and conditions of purchase, including but not limited to the warranty expressed therein, which apply to these products.

Truesemi Semiconductor strives to supply high-quality high-reliability products. However, any and all semiconductor products fail with some probability. It is possible that these probabilistic failures could give rise to accidents or events that could endanger human lives that could give rise to smoke or fire, or that could cause damage to other property. When designing equipment, adopt safety measures so that these kinds of accidents or events cannot occur. Such measures include but are not limited to protective circuits and error prevention circuits for safe design, redundant design, and structural design.

In the event that any or all Truesemi Semiconductor products(including technical data, services) described or contained herein are controlled under any of applicable local export control laws and regulations, such products must not be exported without obtaining the export license from the authorities concerned in accordance with the above law.

Information (including circuit diagrams and circuit parameters) herein is for example only; it is not guaranteed for volume production. Truesemi Semiconductor believes information herein is accurate and reliable, but no guarantees are made or implied regarding its use or any infringements of intellectual property rights or other rights of third parties.