

**45V N-Channel SGT MOSFET**

<p><b>General Description</b></p> <ul style="list-style-type: none"> <li>● Trench Power SGT technology</li> <li>● Very low on-resistance <math>R_{DS(ON)}</math></li> <li>● Low Gate Charge</li> <li>● Excellent Gate Charge x <math>R_{DS(ON)}</math> Product</li> </ul> <p><b>Applications</b></p> <ul style="list-style-type: none"> <li>● High Frequency Switching and Synchronous Rectification</li> </ul>	<p><b>Product Summary</b></p> <table> <tr> <td><math>V_{DS}</math></td> <td>45V</td> </tr> <tr> <td><math>I_D</math> (at <math>V_{GS}=10V</math>)</td> <td>100A</td> </tr> <tr> <td><math>R_{DS(ON)}</math> (at <math>V_{GS}=10V</math>)</td> <td>&lt; 1.7m<math>\Omega</math></td> </tr> <tr> <td><math>R_{DS(ON)}</math> (at <math>V_{GS}=4.5V</math>)</td> <td>&lt; 2.4m<math>\Omega</math></td> </tr> </table> <p>100% DVDS Tested 100% UIS Tested 100% Rg Tested</p> 	$V_{DS}$	45V	$I_D$ (at $V_{GS}=10V$ )	100A	$R_{DS(ON)}$ (at $V_{GS}=10V$ )	< 1.7m $\Omega$	$R_{DS(ON)}$ (at $V_{GS}=4.5V$ )	< 2.4m $\Omega$
$V_{DS}$	45V								
$I_D$ (at $V_{GS}=10V$ )	100A								
$R_{DS(ON)}$ (at $V_{GS}=10V$ )	< 1.7m $\Omega$								
$R_{DS(ON)}$ (at $V_{GS}=4.5V$ )	< 2.4m $\Omega$								

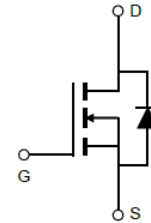
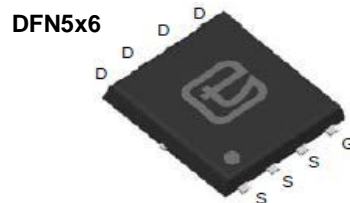

Part Number	Package Type	Form	Marking
TSG017N045AT	DFN5x6	Tape & Reel	TSG017N045AT

**Absolute Maximum Ratings ( $T_A = 25^\circ\text{C}$  unless otherwise noted)**

Parameter	Symbol	Maximum	Units
Drain-Source Voltage	$V_{DS}$	45	V
Gate-Source Voltage	$V_{GS}$	$\pm 20$	V
Continuous Drain Current <sup>B</sup>	$I_D$	$T_C = 25^\circ\text{C}$	100 (package limited)
		$T_C = 100^\circ\text{C}$	100 (package limited)
Pulsed Drain Current <sup>A</sup>	$I_{DM}$	400	A
Avalanche Current <sup>A</sup>	$I_{AS}$	58	A
Single Pulse Avalanche Energy	$E_{AS}$	504.6	mJ
Power Dissipation <sup>C</sup>	$P_D$	$T_C = 25^\circ\text{C}$	125
		$T_C = 100^\circ\text{C}$	50
Junction and Storage Temperature Range	$T_J, T_{STG}$	-55 to 150	$^\circ\text{C}$

**Thermal Characteristics**

Parameter	Symbol	Maximum	Units
Maximum Junction-to-Case	$R_{\theta JC}$	1.0	$^\circ\text{C}/\text{W}$
Maximum Junction-to-Ambient	$R_{\theta JA}$	50	



Electrical Characteristics( $T_J = 25^\circ\text{C}$ unless otherwise noted)						
Symbol	Parameter	Conditions	Value			Units
			Min	Typ	Max	
<b>STATIC PARAMETERS</b>						
$BV_{DSS}$	Drain-Source Breakdown Voltage	$I_D = 250\mu\text{A}, V_{GS} = 0\text{V}$	45			V
$I_{DSS}$	Zero Gate Voltage Drain Current	$V_{DS} = 45\text{V}, V_{GS} = 0\text{V}$	$T_J = 25^\circ\text{C}$		1	$\mu\text{A}$
			$T_J = 125^\circ\text{C}$		100	
$I_{GSS}$	Gate-Body Leakage Current	$V_{DS} = 0\text{V}, V_{GS} = \pm 20\text{V}$			$\pm 100$	nA
$V_{GS(th)}$	Gate Threshold Voltage	$V_{DS} = V_{GS}, I_D = 250\mu\text{A}$	1	1.6	2.4	V
$R_{DS(on)}$	Static Drain-Source On-Resistance	$V_{GS} = 10\text{V}, I_D = 30\text{A}$		1.5	1.7	$\text{m}\Omega$
		$V_{GS} = 4.5\text{V}, I_D = 30\text{A}$		2	2.4	$\text{m}\Omega$
$g_{FS}$	Forward Transconductance	$V_{DS} = 5\text{V}, I_D = 20\text{A}$		56.8		S
$V_{SD}$	Diode Forward Voltage	$I_S = 30\text{A}, V_{GS} = 0\text{V}$			1	V
$I_S$	Maximum Body-Diode Continuous Current <sup>B</sup>				100	A
<b>DYNAMIC PARAMETERS</b>						
$C_{iss}$	Input Capacitance	$V_{GS} = 0\text{V}, V_{DS} = 25\text{V}, f = 1\text{MHz}$		5096		$\text{pF}$
$C_{oss}$	Output Capacitance			1213		
$C_{rss}$	Reverse Transfer Capacitance			140		
$R_g$	Gate Resistance	$f = 1\text{MHz}$		3.4		$\Omega$
<b>SWITCHING PARAMETERS</b>						
$Q_g(10\text{V})$	Total Gate Charge	$V_{GS} = 10\text{V}, V_{DS} = 20\text{V}, I_D = 20\text{A}$		82		nC
$Q_g(4.5\text{V})$	Total Gate Charge			38		
$Q_{gs}$	Gate Source Charge			16		
$Q_{gd}$	Gate Drain Charge			12		
$Q_{oss}$	Output Charge	$V_{GS} = 0\text{V}, V_{DS} = 20\text{V}$		49.6		
$t_{D(on)}$	Turn-On Delay Time	$V_{GS} = 10\text{V}, V_{DS} = 20\text{V}, I_D = 20\text{A}, R_G = 1.6\Omega$		26		ns
$t_r$	Turn-On Rise Time			5		
$T_{D(off)}$	Turn-Off Delay Time			47		
$t_f$	Turn-Off Fall Time			10.5		
$t_{rr}$	Body Diode Reverse Recovery Time	$I_F = 20\text{A}, di/dt = 100\text{A}/\mu\text{s}$		35		ns
$Q_{rr}$	Body Diode Reverse Recovery Charge			78		nC

A. Single pulse width limited by maximum junction temperature.

B. The maximum current rating is package limited.

C. The power dissipation  $P_D$  is based on  $T_{J(MAX)} = 150^\circ\text{C}$ , using junction-to-case thermal resistance, and is more useful in setting the upper dissipation limit for cases where additional heatsinking is used.



### TYPICAL ELECTRICAL AND THERMAL CHARACTERISTICS

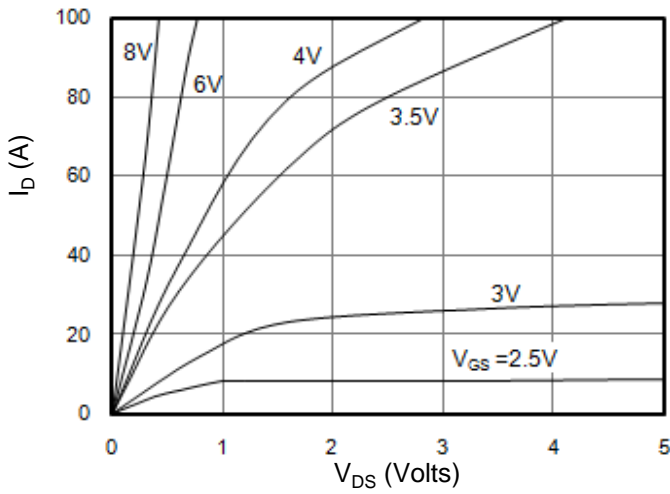

Figure 1: On-Region Characteristics

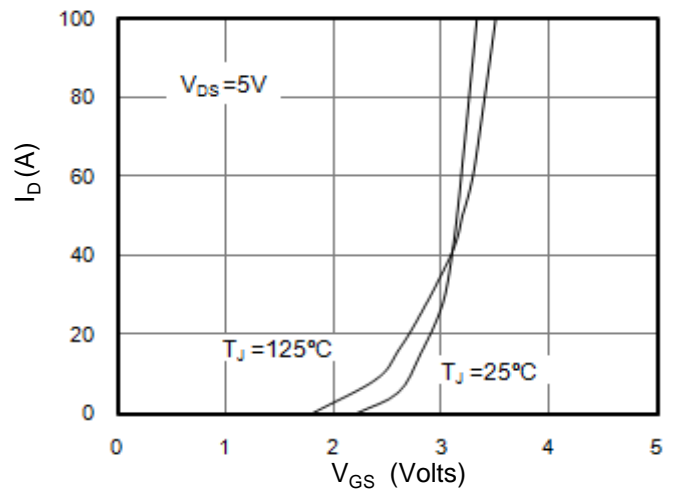

Figure 2: Transfer Characteristics

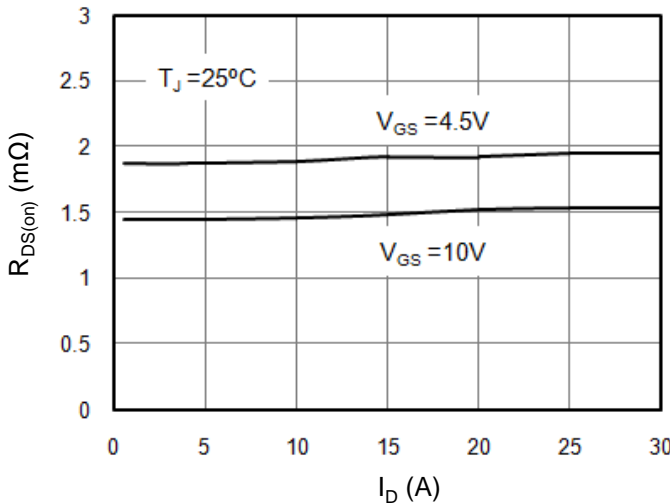

Figure 3: On-Resistance vs. Drain Current

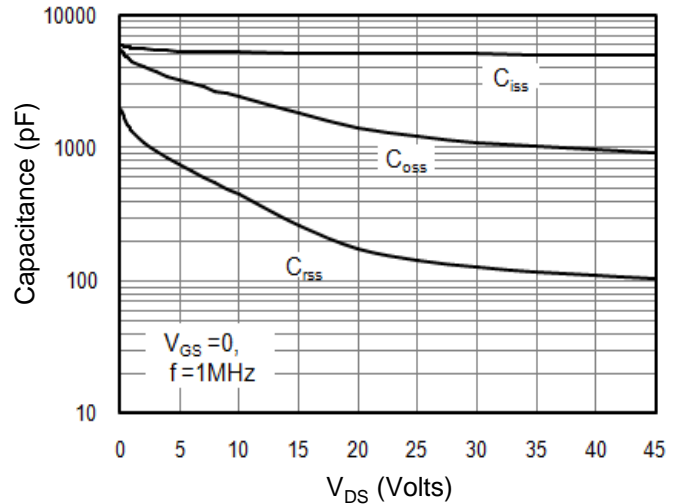

Figure 4: Capacitance Characteristics

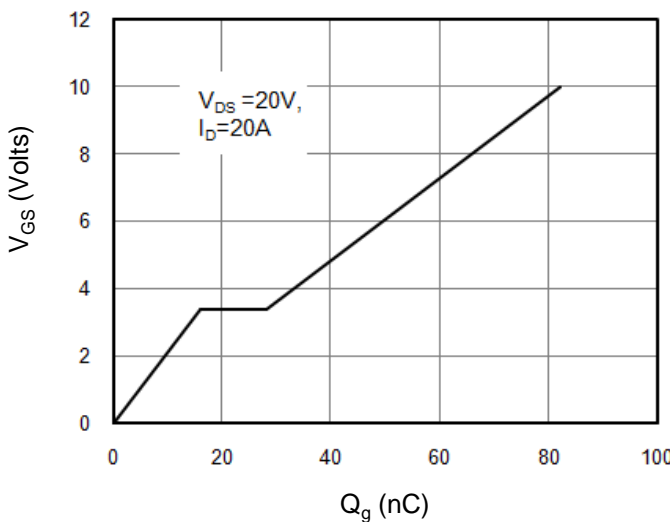

Figure 5: Gate Charge Characteristics

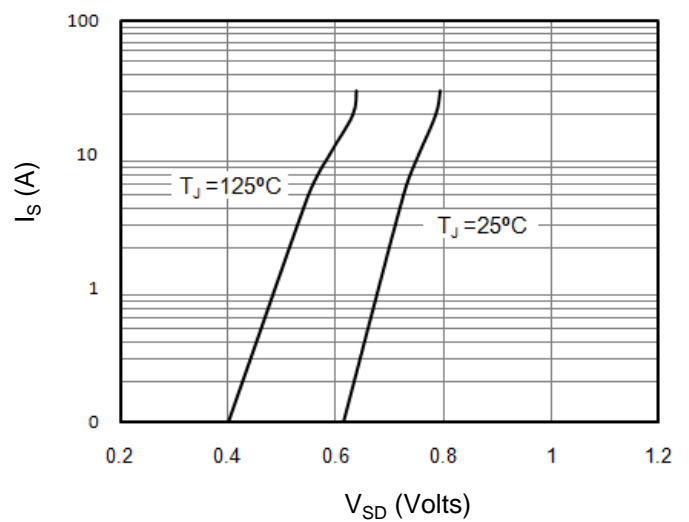

Figure 6: Body Diode Forward Voltage



### TYPICAL ELECTRICAL AND THERMAL CHARACTERISTICS

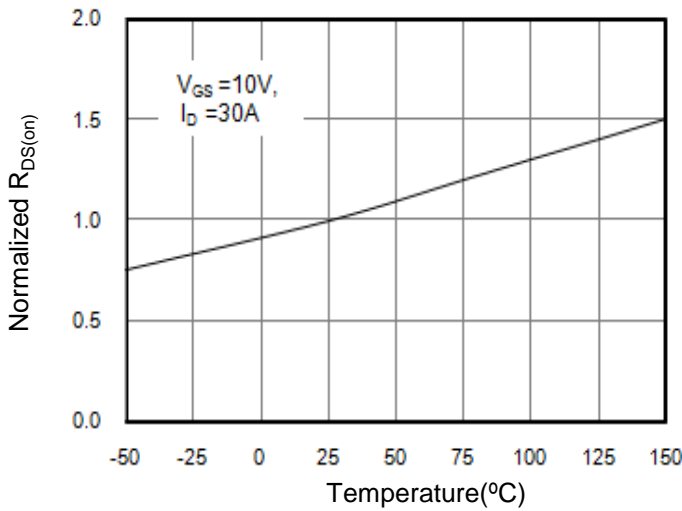

Figure 7: On-Resistance vs. Junction Temperature

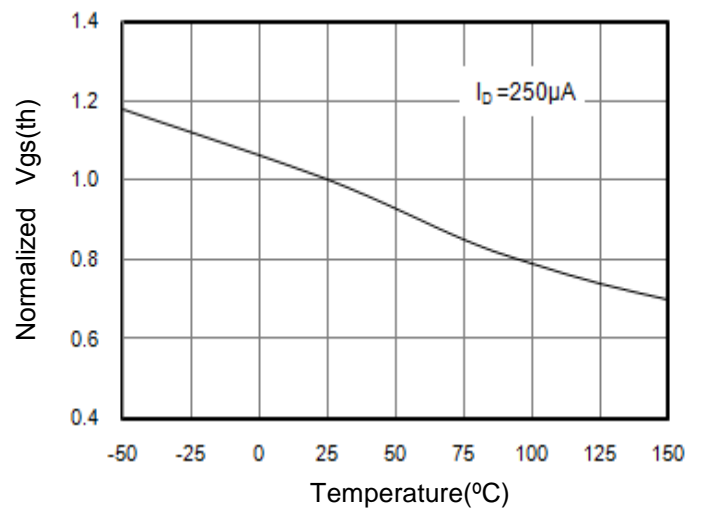

Figure 8: V\_GS(th) vs. Junction Temperature

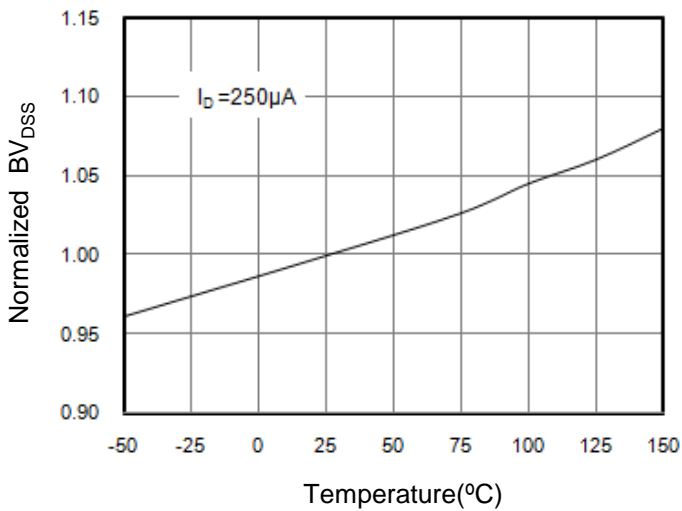

Figure 9: BV\_DSS vs. Junction Temperature

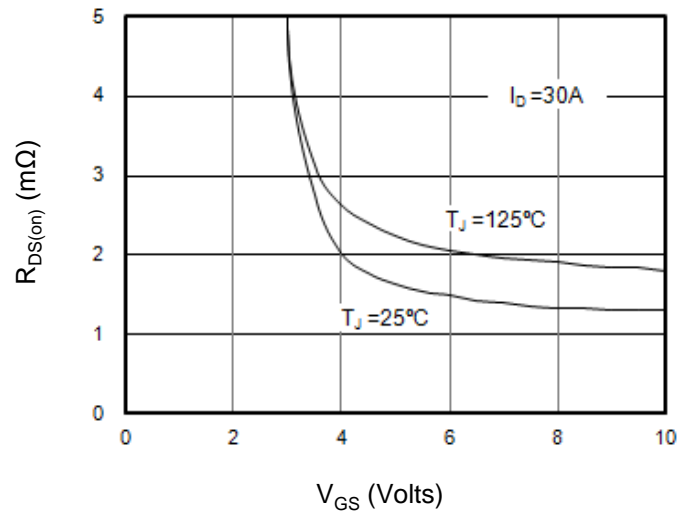

Figure 10: On-Resistance vs. Gate-Source Voltage

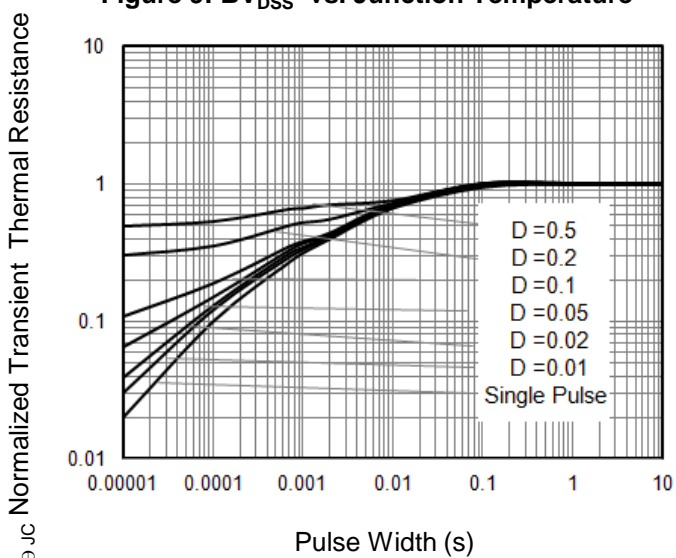

Figure 11: Normalized Transient Thermal Resistance

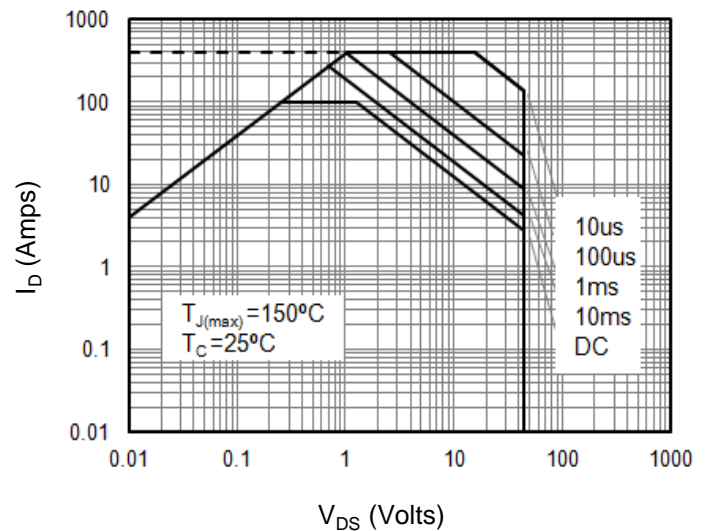

Figure 12: Safe Operating Area



Figure A: Gate Charge Test Circuit and Waveforms

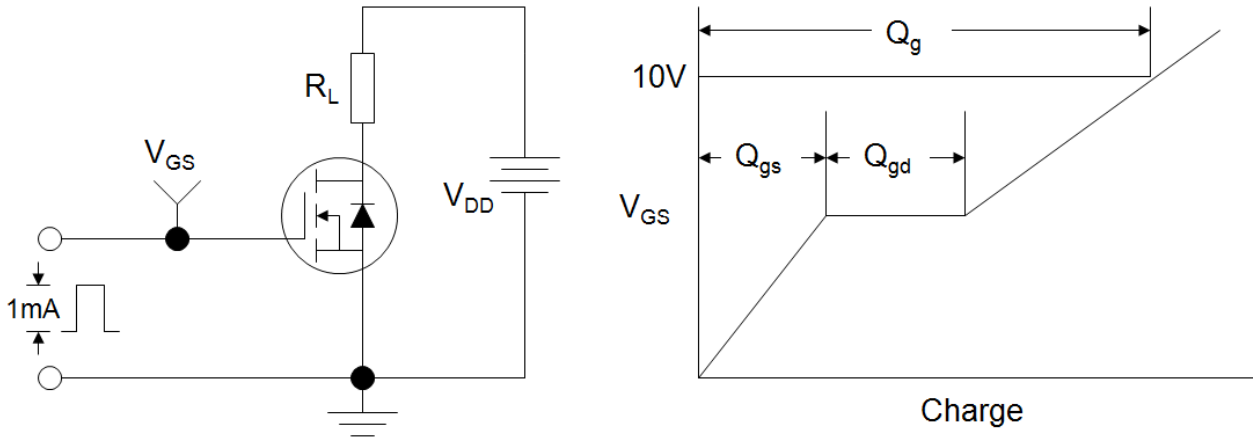

Figure B: Resistive Switching Test Circuit and Waveforms

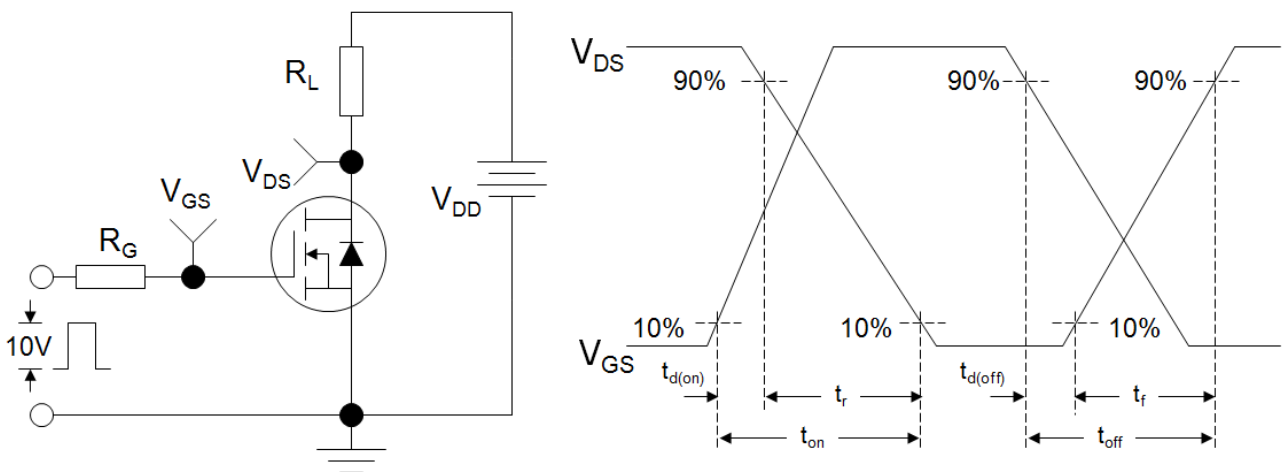
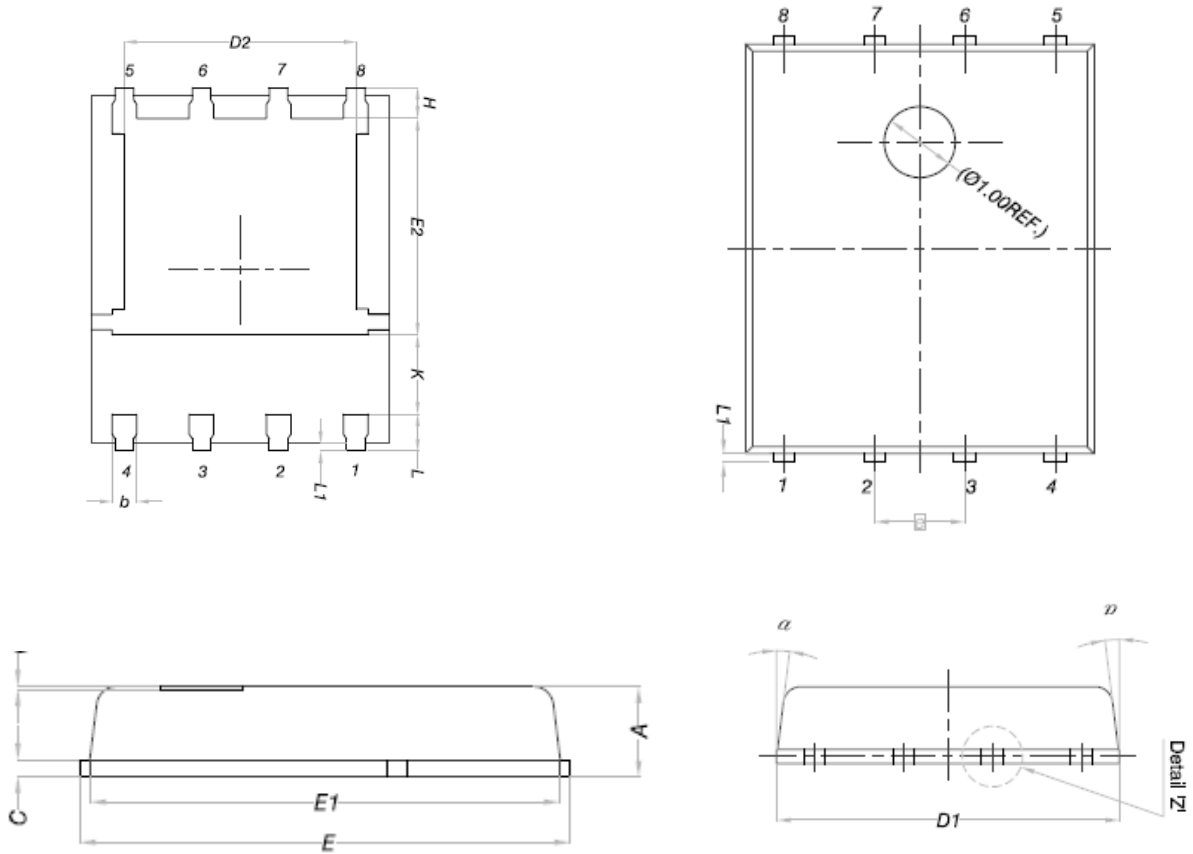

Figure C: Unclamped Inductive Switching (UIS) Test Circuit and Waveforms





## DFN5x6



DIM.	MILLIMETERS			DIM.	MILLIMETERS		
	MIN.	NOM.	MAX.		MIN.	NOM.	MAX.
A	0.90	1.00	1.10	E	5.90	6.00	6.10
A1	0	-	0.05	E1	5.70	5.75	5.80
b	0.33	0.41	0.51	E2	3.38	3.58	3.78
C	0.20	0.25	0.30	e	1.27 BSC		
D1	4.80	4.90	5.00	H	0.41	0.51	0.61
D2	3.61	3.81	3.96	K	1.10	-	-
				L	0.51	0.61	0.71
				L1	0.06	0.13	0.20
				α	0°	-	12°



## Disclaimer

All product specifications and data are subject to change without notice.

For documents and material available from this datasheet, Wuxi Unigroup does not warrant or assume any legal liability or responsibility for the accuracy, completeness of any product or technology disclosed hereunder.

No license, express or implied, by estoppels or otherwise, to any intellectual property rights is granted by this document or by any conduct of Wuxi Unigroup.

The products shown herein are not designed for use in medical, life-saving, or life-sustaining applications. Customers using or selling Wuxi Unigroup products not expressly indicated for use in such applications do so entirely at their own risk and agree to fully indemnify Wuxi Unigroup for any damages arising or resulting from such use or sale.

Wuxi Unigroup disclaims any and all liability arising out of the use or application of any product described herein or of any information provided herein to the maximum extent permitted by law. The product specifications do not expand or otherwise modify Wuxi Unigroup's terms and conditions of purchase, including but not limited to the warranty expressed therein, which apply to these products.

Wuxi Unigroup Microelectronics CO., LTD. strives to supply high-quality high-reliability products. However, any and all semiconductor products fail with some probability. It is possible that these probabilistic failures could give rise to accidents or events that could endanger human lives that could give rise to smoke or fire, or that could cause damage to other property. When designing equipment, adopt safety measures so that these kinds of accidents or events cannot occur. Such measures include but are not limited to protective circuits and error prevention circuits for safe design, redundant design, and structural design.

In the event that any or all Wuxi Unigroup products (including technical data, services) described or contained herein are controlled under any of applicable local export control laws and regulations, such products must not be exported without obtaining the export license from the authorities concerned in accordance with the above law.

Information (including circuit diagrams and circuit parameters) herein is for example only. It is not guaranteed for volume production. Wuxi Unigroup believes information herein is accurate and reliable, but no guarantees are made or implied regarding its use or any infringements of intellectual property rights or other rights of third parties.