

CBB28

Metallized Polypropylene Film Capacitors

金属化聚丙烯膜电容器

CBB28



产品特点.Characteristics

- 金属化聚丙烯膜内串式结构;
- 具有自愈性;
- 能承受较高的电压;
- 阻燃环氧树脂粉末包封。
- Metallized polypropylene inner series structure
- Self-healing
- It can be bear high voltage
- Flame retardant epoxy resin wrapping

产品应用.Application

- 广泛应用于高频、直流和脉冲电路中;
- Widely used in high frequency, direct current and pulse circuits

性能参数.Technical Data

● 引用标准Reference Standard	GB/T 10190(IEC 60384-16)	
● 气候类别 Climatic Category	40/085/21	
● 工作温度范围Operating temperature range	-40°C~85°C Tmax 105°C	
● 额定电压Rated voltage	100VDC、250VDC、400VDC、630VDC	
● 电容量范围Capacitance range	0.001 μF~0.68 μF	
● 电容量偏差Capacitance tolerance	±5%(J); ±10%(K); ±20%(M)	
● 耐电压Withstand voltage	2UN 5S (at20±5°C)	
● 损耗角正切Dissipation factor	tgδ≤0.0010 (20°C, 1KHz)	
● 绝缘电阻Insulation resistance	≥30000MΩ(at 20°C 100VDC 1Min)	
● 最大脉冲爬升速度Maximum Pulse Rise Time(dv/dt)	Un(VDC)	dv/dt(V/μS)
	630	300
	1000	350
	1250	400

结构图.Construction Diagram

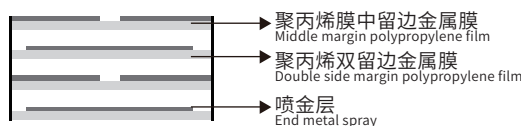

CBB28

Metallized Polypropylene Film Capacitors

产品外形.Product Shape

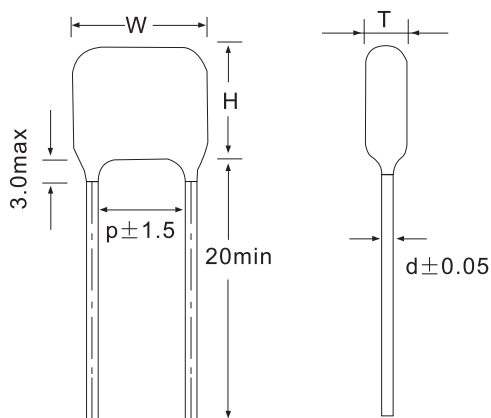

频率特性.Temperature Characteristics

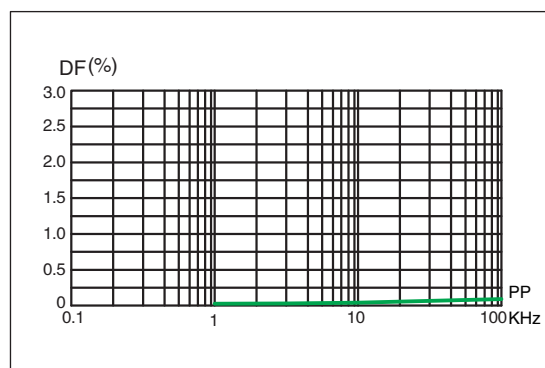
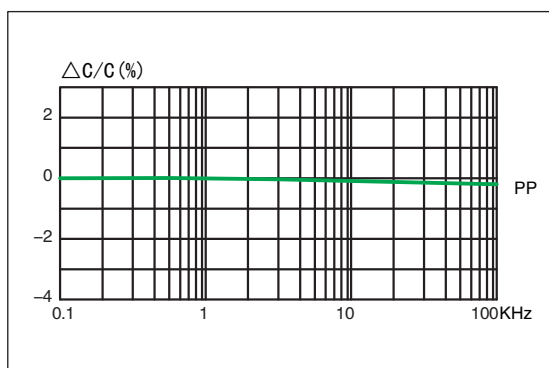

温度特性.Frequency Characteristics

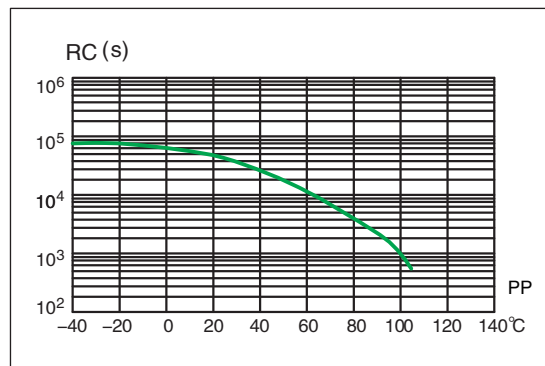
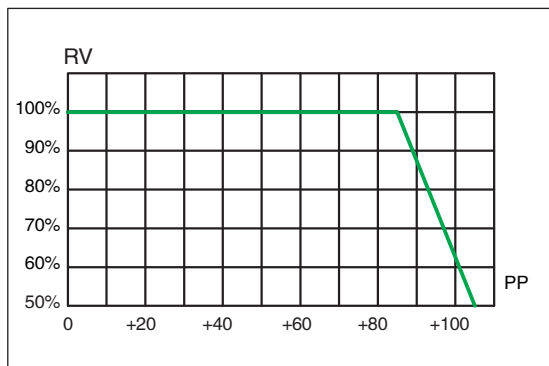
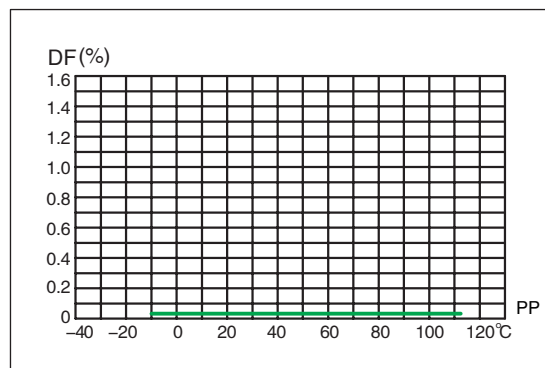
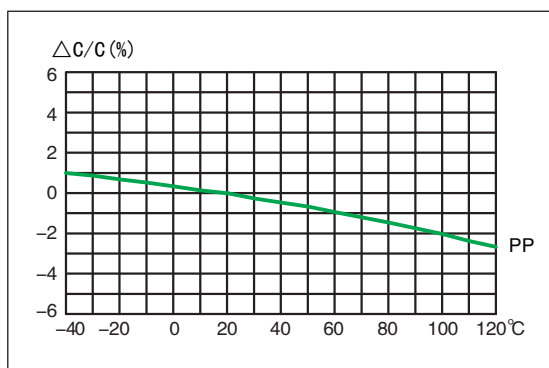

CBB28

Metallized Polypropylene Film Capacitors

参数表.Article Table

R 系列尺寸图

Capacity (μ F)	尺寸标注 Size mark	630V					1000V					1250V				
		Wmax	Hmax	Tmax	P	d	Wmax	Hmax	Tmax	P	d	Wmax	Hmax	Tmax	P	d
0.0010	R	13.0	5.5	10.0	10.0	0.6	13.0	5.0	9.0	10.0	0.6	13.0	5.0	9.0	10.0	0.6
0.0015	R	13.0	6.0	10.0	10.0	0.6	13.0	6.0	10.0	10.0	0.6	13.0	6.0	10.0	10.0	0.6
0.0022	R	13.0	6.0	10.0	10.0	0.6	13.0	6.0	10.0	10.0	0.6	13.0	6.0	10.0	10.0	0.6
0.0033	R	13.0	5.5	10.0	10.0	0.6	13.0	5.5	9.5	10.0	0.6	13.0	5.5	9.5	10.0	0.6
0.0047	R	13.0	6.0	10.5	10.0	0.6	13.0	6.0	10.0	10.0	0.6	13.0	6.0	10.0	10.0	0.6
0.0068	R	13.0	6.5	10.5	10.0	0.6	13.0	6.5	10.5	10.0	0.6	13.0	6.5	10.5	10.0	0.6
0.0082	R	13.0	7.0	11.5	10.0	0.6	13.0	7.0	11.5	10.0	0.6	13.0	7.0	11.5	10.0	0.6

U 系列尺寸图

Capacity (μ F)	尺寸标注 Size mark	630V					1000V					1250V				
		Wmax	Hmax	Tmax	P	d	Wmax	Hmax	Tmax	P	d	Wmax	Hmax	Tmax	P	d
0.0010	U	13.0	5.0	9.5	10.0	0.6	13.0	5.0	9.0	10.0	0.6	13.0	5.0	9.0	10.0	0.6
0.0015	U	13.0	5.0	9.5	10.0	0.6	13.0	5.0	9.5	10.0	0.6	13.0	5.0	9.5	10.0	0.6
0.0022	U	13.0	5.0	9.5	10.0	0.6	13.0	5.5	9.5	10.0	0.6	13.0	5.5	9.5	10.0	0.6
0.0033	U	13.0	5.0	9.5	10.0	0.6	13.0	5.0	9.0	10.0	0.6	13.0	5.0	9.0	10.0	0.6
0.0047	U	13.0	5.5	10.0	10.0	0.6	13.0	5.5	10.0	10.0	0.6	13.0	5.5	10.0	10.0	0.6
0.0068	U	13.0	6.0	10.0	10.0	0.6	13.0	6.0	10.0	10.0	0.6	13.0	6.0	10.0	10.0	0.6
0.0082	U	13.0	6.5	11.0	10.0	0.6	13.0	6.5	11.0	10.0	0.6	13.0	6.5	11.0	10.0	0.6

以上表格/图形仅供参考,以实物为准。

The above table / graphics are for reference only, subject to the actual product (unit: mm)

特别说明:

R:出厂测试电压为耐压的2倍,体积较U产品略大

U:出厂测试电压为耐压的1.6倍,体积较R产品略小
(产品体积详细参考以上表格内容)

Remark:

The R: factory test voltage is 2 times the withstand voltage, and the volume is slightly larger than that of the U product.

The U: factory test voltage is 1.6 times the withstand voltage, and the volume is slightly smaller than that of the R product.
(volume of products refer to the above table).