



TAI-SAW TECHNOLOGY CO., LTD.

No. 3, Industrial 2nd Rd., Ping-Chen Industrial District,
Taoyuan, 324, Taiwan, R.O.C.

TEL: 886-3-4690038 FAX: 886-3-4697532

E-mail: tstsales@mail.taisaw.com Web: www.taisaw.com

Approval Sheet For Product Specification

Issued Date:

Product Name: SAW Filter 748 MHz SMD 3.8x3.8 mm

TST Parts No.:TA1005A

Customer Parts No.: _____

Company: _____
Division: _____
Approved by : _____
Date: _____

Checked by: _____ David Chang 張閔智

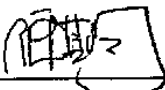
Approval by: _____ Francis Chen 

Date: _____ 2009/03/13



TAI-SAW TECHNOLOGY CO., LTD.

No. 3, Industrial 2nd Rd., Ping-Chen Industrial District,
Taoyuan, 324, Taiwan, R.O.C.

TEL: 886-3-4690038 FAX: 886-3-4697532

E-mail: tstsales@mail.taisaw.com Web: www.taisaw.com

SAW Filter 748MHz

MODEL NO.:TA1005A

REV. NO.:1

A. MAXIMUM RATING:

1. Input Power Level: 10 dBm
2. DC Voltage : 3V
3. Operating Temperature: -20°C to +75°C
4. Storage Temperature: -40°C to +85°C

RoHS Compliant
Lead free
Lead-free soldering

B. ELECTRICAL CHARACTERISTICS:

Item	Unit	Min.	Type.	Max.
Center frequency F_c	MHz	-	748	-
Insertion loss (732~764 MHz) IL	dB	-	3.0	4.5
Amplitude Ripple (732~764 MHz)	dB	-	1.3	3.0
Attenuation (Reference level from 0 dB)				
0 ~ 700 MHz	dB	45	53	-
700 ~ 708 MHz	dB	40	54	-
708 ~ 720 MHz	dB	20	31	-
790 ~ 820 MHz	dB	20	39	-
820 ~ 1000 MHz	dB	45	52	-
Temperature Coefficient of Frequency	Ppm/°C	-	-35	-

C. MEASUREMENT CIRCUIT:

HP Network analyzer

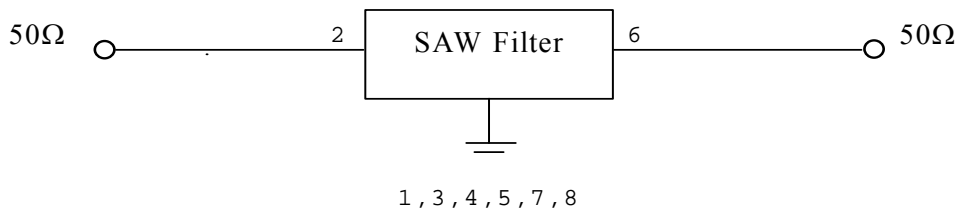

D.OUTLINE DRAWING:

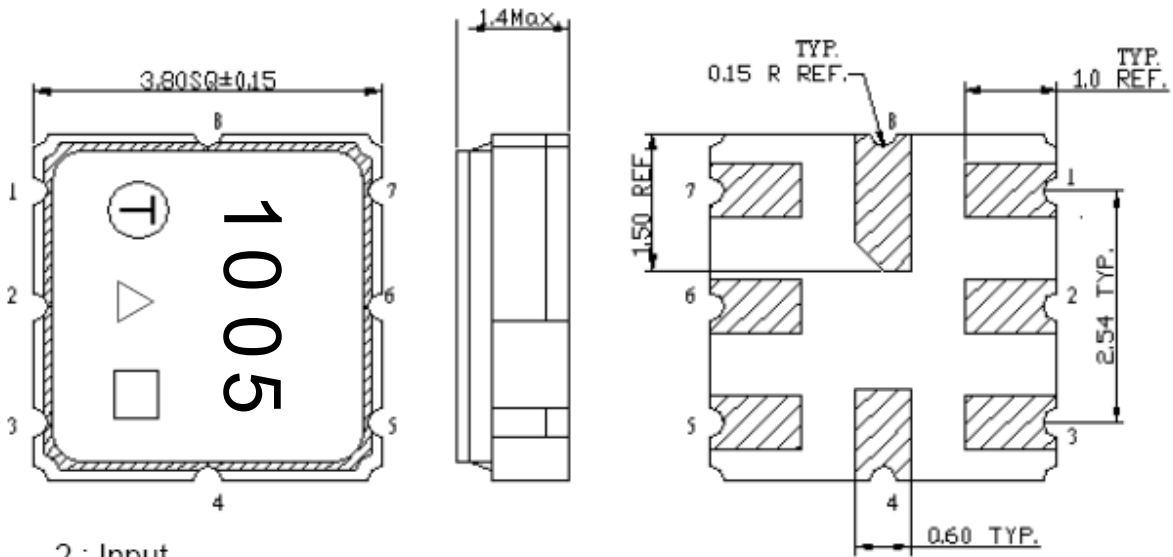

- 2 : Input
- 6: Output
- 1,3,4,5,7,8: Ground
- △ : Year Code
- : Date Code (W01->A, W02->B,...,W52->z)

△ Product Year Code

Year	2007	2008
	2009	2010
	2011	2012
Product Code	A	a

E. PCB Footprint:

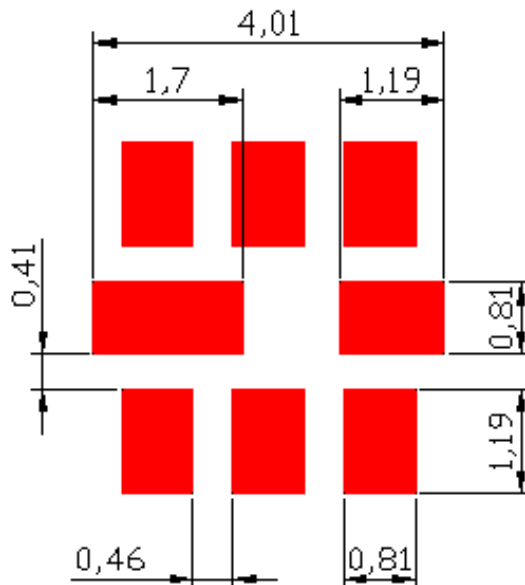

F. Frequency Characteristics :

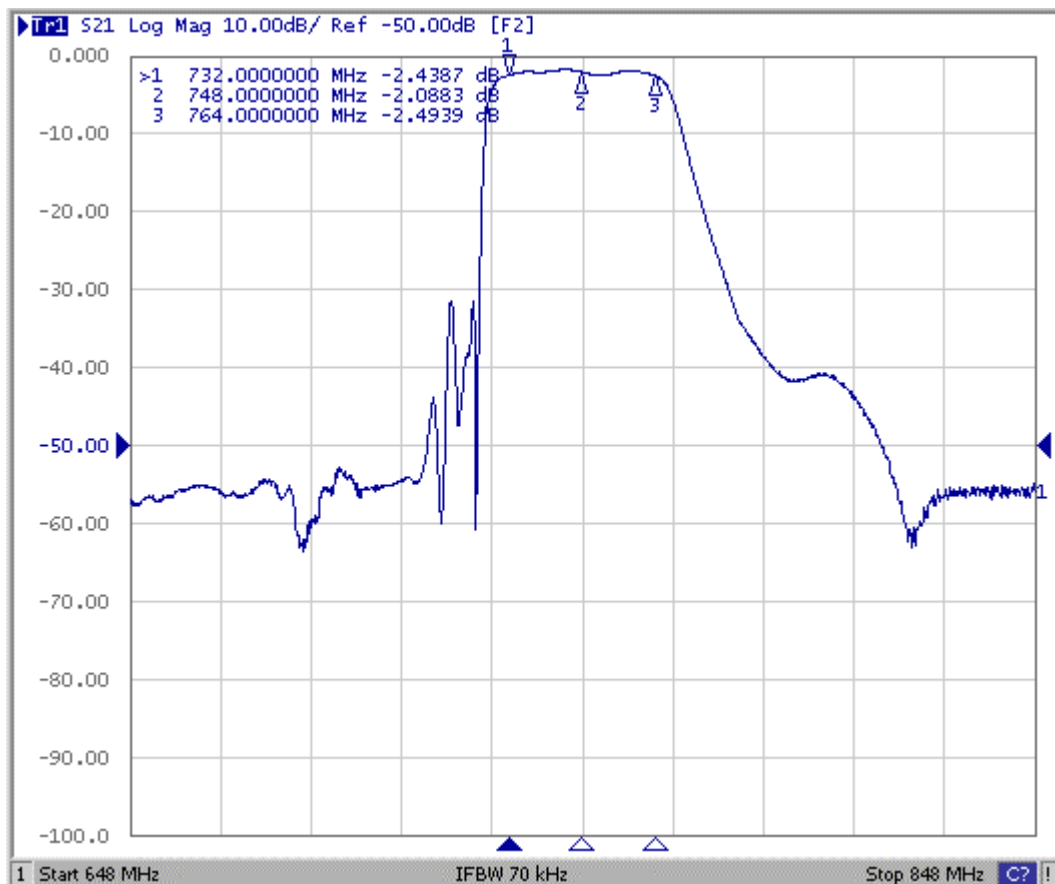
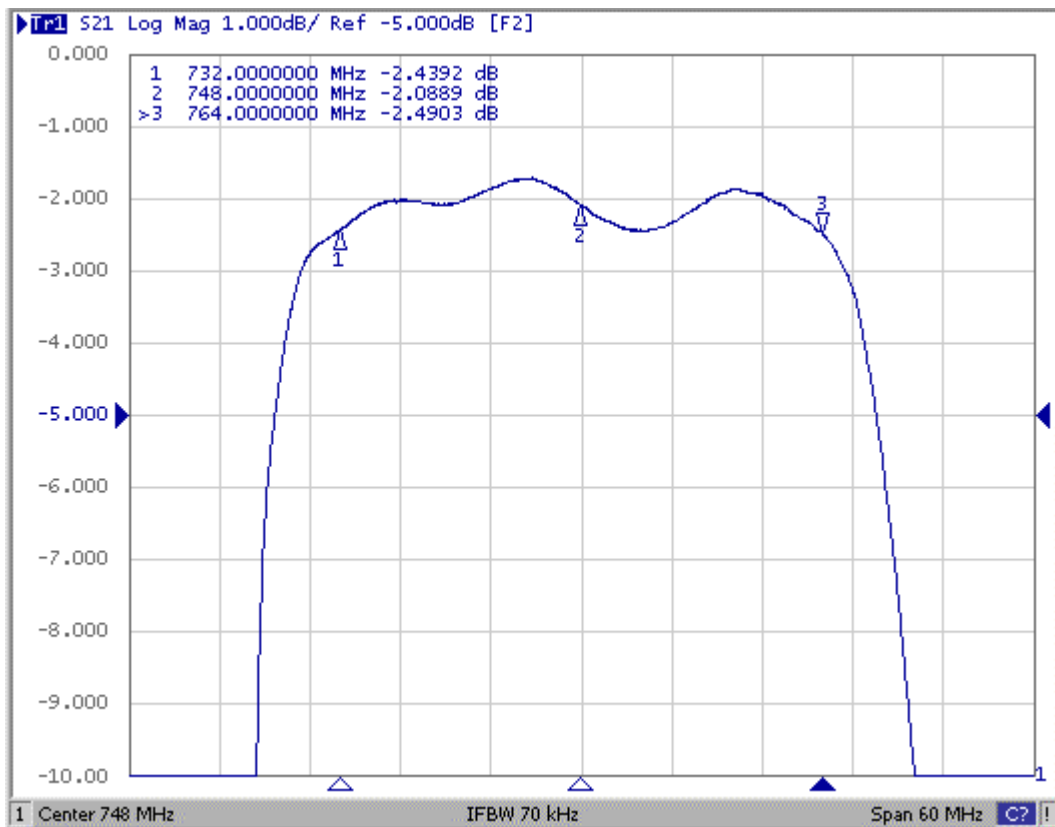

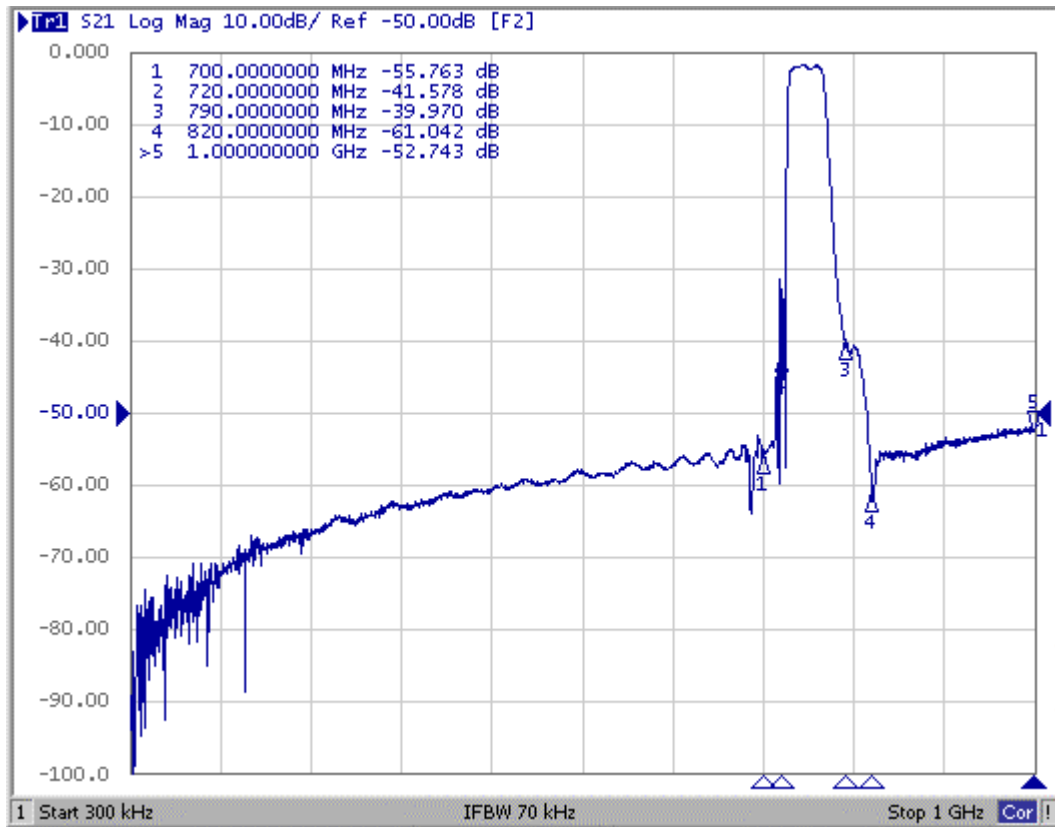

G. PACKING:

1. REEL DIMENSION

