

**P-Channel 30V (D-S) MOSFET**

**GENERAL DESCRIPTION**

The ME9435 is the P-Channel logic enhancement mode power field effect transistors, using high cell density, DMOS trench technology.

This high density process is especially tailored to minimize on-state resistance. These devices are particularly suited for low voltage application such as cellular phone, notebook computer power management and other battery powered circuits, and in-line power loss that are needed in a very small outline surface mount package.

**PIN CONFIGURATION**

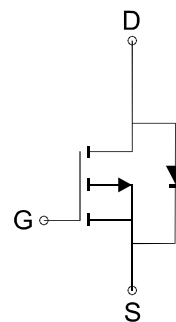
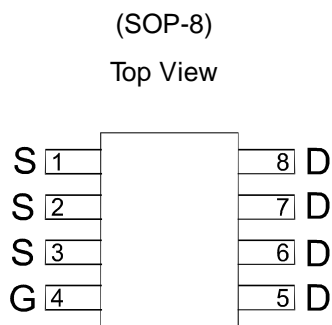

P-Channel MOSFET

**FEATURES**

- $R_{DS(ON)} \leq 60m\Omega @ V_{GS} = -10V$
- $R_{DS(ON)} \leq 90m\Omega @ V_{GS} = -4.5V$
- Super high density cell design for extremely low  $R_{DS(ON)}$
- Exceptional on-resistance and maximum DC current capability

**APPLICATIONS**

- Power Management in Note book
- Portable Equipment
- Battery Powered System
- DC/DC Converter
- Load Switch
- DSC
- LCD Display inverter

Ordering Information: ME9435 (Pb-free)

ME9435-G (Green product-Halogen free)

**Absolute Maximum Ratings (TA=25°C Unless Otherwise Noted)**

Parameter	Symbol	Maximun Rating	Unit
Drain-Source Voltage	$V_{DS}$	-30	V
Gate-Source Voltage	$V_{GS}$	$\pm 20$	V
Continuous Drain Current	$I_D$	$T_A = 25^\circ C$	-5.1
		$T_A = 70^\circ C$	-4.1
Pulsed Drain Current	$I_{DM}$	-20	A
Maximum Power Dissipation	$P_D$	$T_A = 25^\circ C$	2.5
		$T_A = 70^\circ C$	1.6
Operating Junction Temperature	$T_J$	-55 to 150	°C
Junction-to-Ambient Thermal Resistance	$R_{\theta JA}$	50	°C/W

\*The device mounted on 1in<sup>2</sup> FR4 board with 2 oz copper

DCC  
正式發行

## P-Channel 30V (D-S) MOSFET

Electrical Characteristics (TA=25°C Unless Otherwise Specified)

Symbol	Parameter	Limit	Min	Typ	Max	Unit
<b>STATIC</b>						
BV <sub>DSS</sub>	Drain-Source Breakdown Voltage	V <sub>GS</sub> =0, I <sub>D</sub> =-250 μA	-30			V
V <sub>GS(th)</sub>	Gate Threshold Voltage	V <sub>DS</sub> =V <sub>GS</sub> , I <sub>D</sub> =-250 μA	-1		-3	V
I <sub>GSS</sub>	Gate Body Leakage	V <sub>DS</sub> =0V, V <sub>GS</sub> =±20V			±100	nA
I <sub>DSS</sub>	Zero Gate Voltage Drain Current	V <sub>DS</sub> =-30V, V <sub>GS</sub> =0V			-1	μA
R <sub>DS(ON)</sub>	Drain-Source On-Resistance	V <sub>GS</sub> =-10V, I <sub>D</sub> = -5.3A		50	60	mΩ
		V <sub>GS</sub> =-4.5V, I <sub>D</sub> = -4.2A		70	90	
V <sub>SD</sub>	Diode Forward Voltage	I <sub>S</sub> =-5.3A, V <sub>GS</sub> =0V		-0.9	-1.2	V
<b>DYNAMIC</b>						
Q <sub>g</sub>	Total Gate Charge	V <sub>DS</sub> =-15V, V <sub>GS</sub> =-10V, I <sub>D</sub> =-5.3A		13		pF
Q <sub>g</sub>	Total Gate Charge	V <sub>DS</sub> =-15V, V <sub>GS</sub> =-4.5V, I <sub>D</sub> =-5.3A		6.2		
Q <sub>gs</sub>	Gate-Source Charge			3.5		
Q <sub>gd</sub>	Gate-Drain Charge			2		
C <sub>iss</sub>	Input capacitance	V <sub>DS</sub> =-15V, V <sub>GS</sub> =0V, f=1MHz		446		nC
C <sub>oss</sub>	Output Capacitance			55		
C <sub>rss</sub>	Reverse Transfer Capacitance			50		
t <sub>d(on)</sub>	Turn-On Delay Time	V <sub>DD</sub> =-15V, R <sub>L</sub> =15Ω I <sub>D</sub> =-1A, V <sub>GEN</sub> =-10V R <sub>G</sub> =6Ω		29		ns
t <sub>r</sub>	Turn-On Rise Time			13		
t <sub>d(off)</sub>	Turn-Off Delay Time			39		
t <sub>f</sub>	Turn-Off Fall Time			5.5		

Notes: a. Pulse test; pulse width ≤ 300us, duty cycle ≤ 2%

b. Matsuki Electric/ Force mos reserves the right to improve product design, functions and reliability without notice.

DCC  
正式發行

**P-Channel 30V (D-S) MOSFET**

**Typical Characteristics (T<sub>J</sub> = 25°C Noted)**

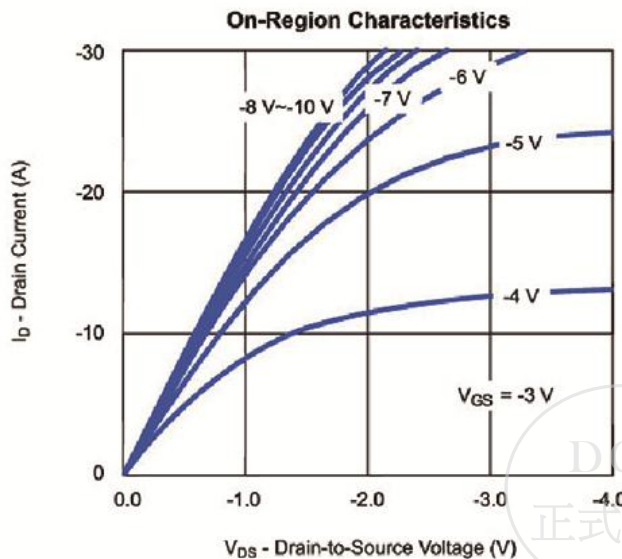
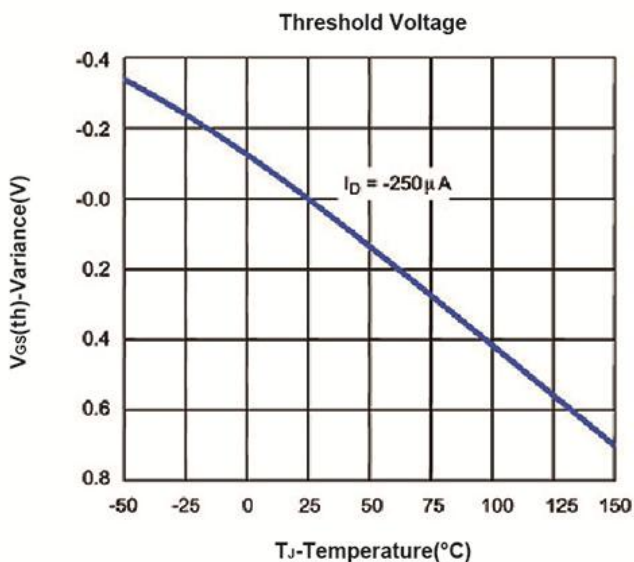
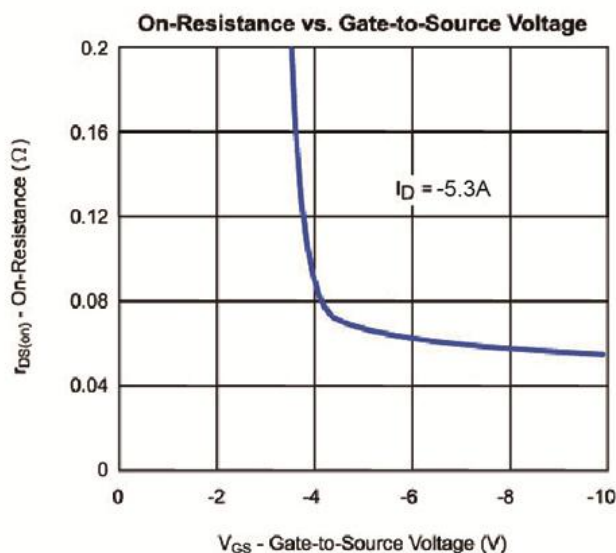
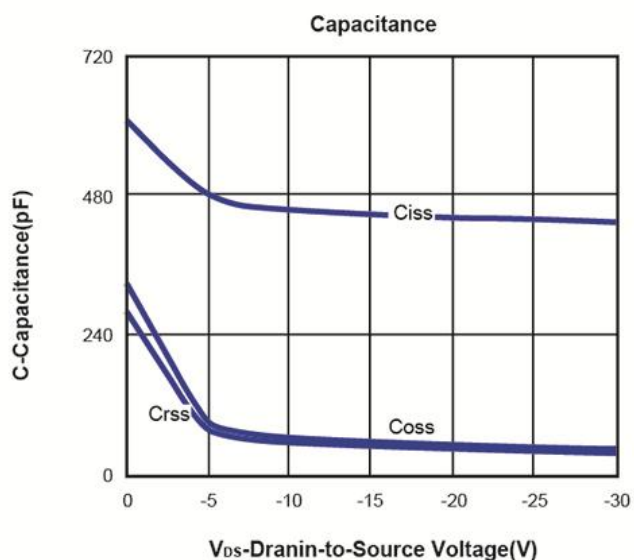
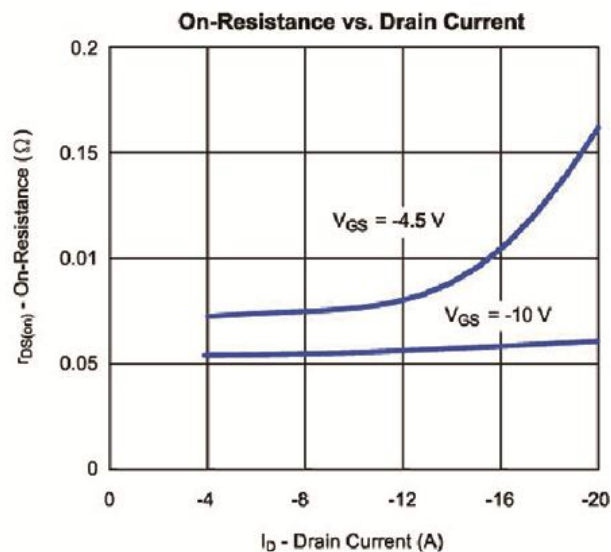
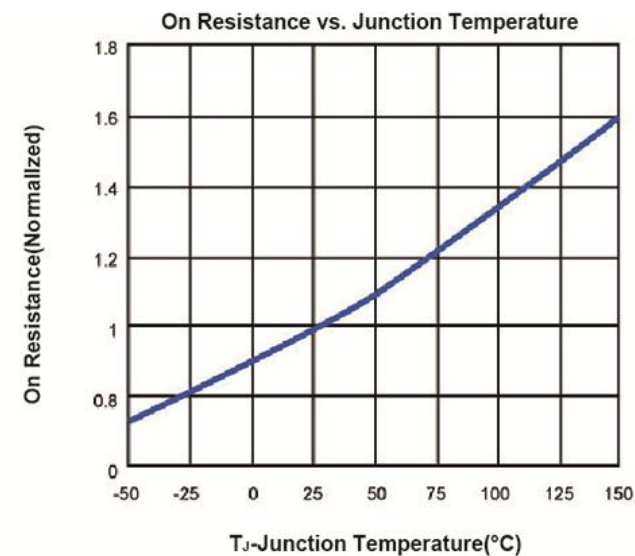

DCC  
正式發行

**P-Channel 30V (D-S) MOSFET**

**Typical Characteristics (T<sub>J</sub> = 25°C Noted)**

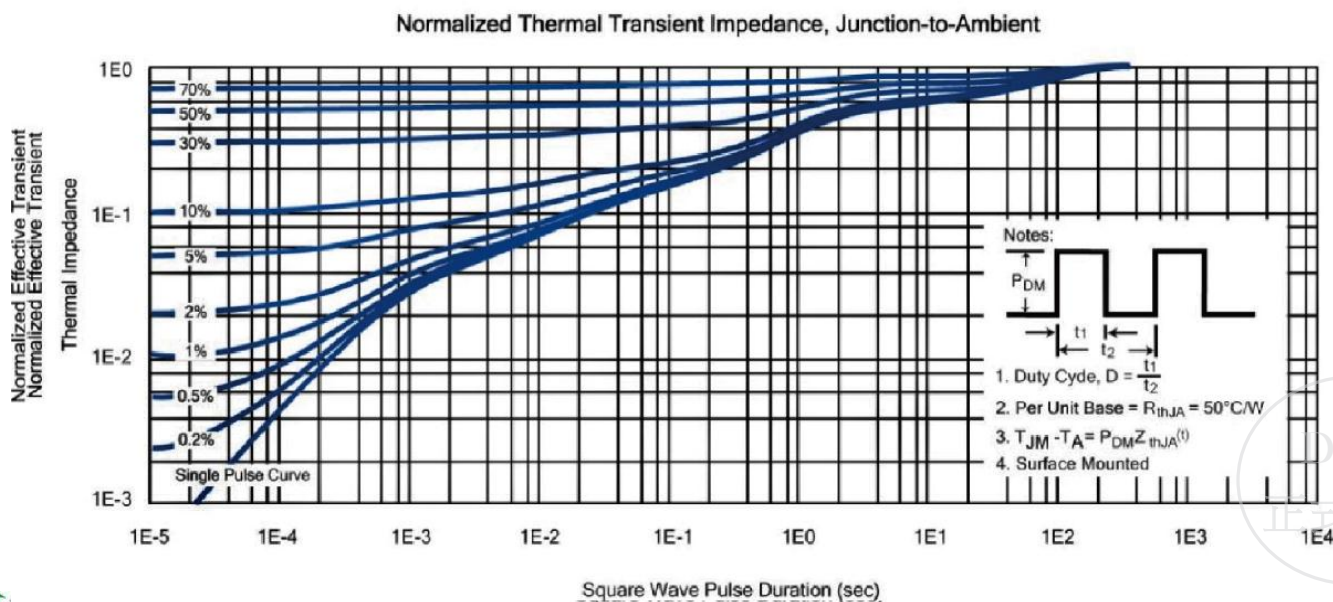
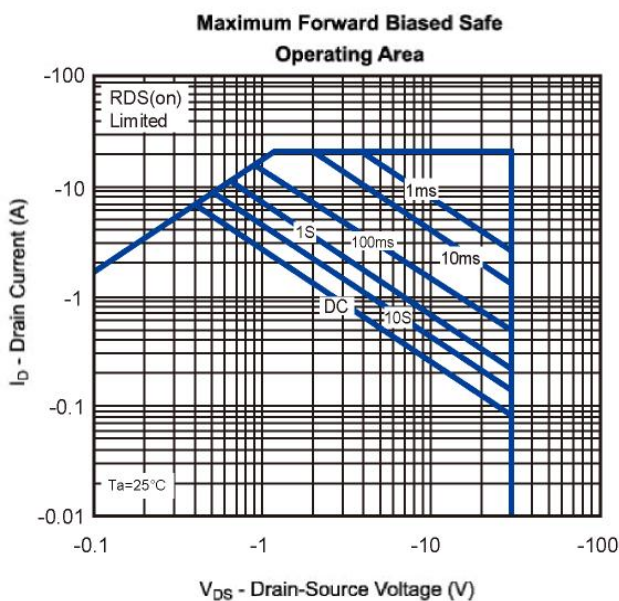
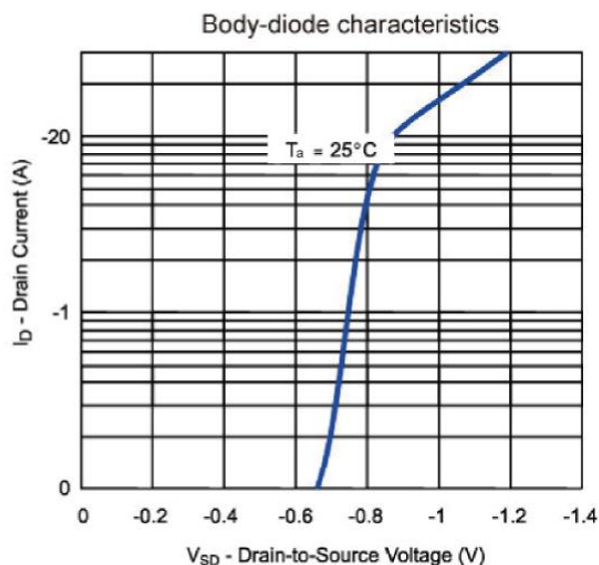
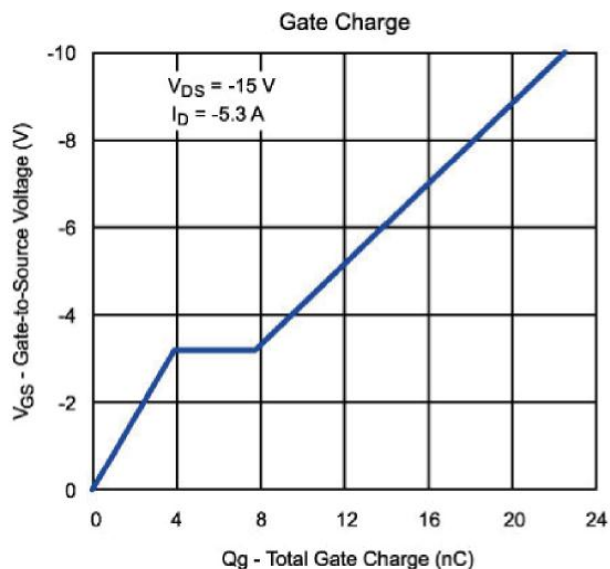

**SOP-8 Package Outline**

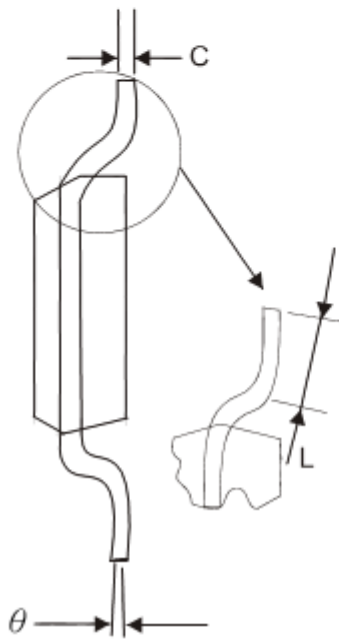
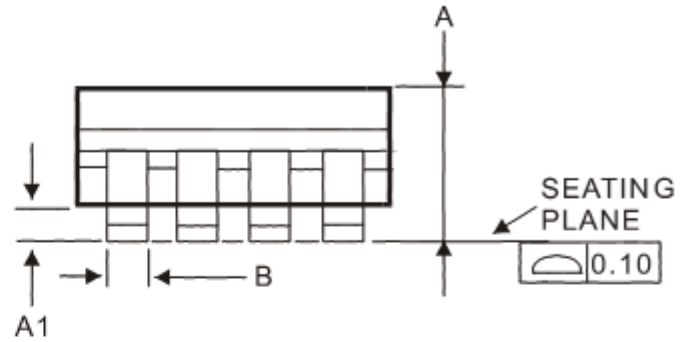
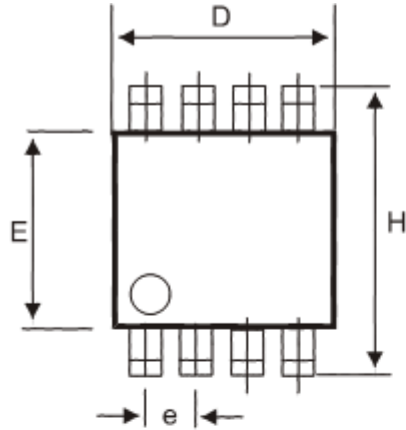

DIM	MILLIMETERS (mm)	
	MIN	MAX
A	1.35	1.75
A1	0.10	0.25
B	0.35	0.49
C	0.18	0.25
D	4.80	5.00
E	3.80	4.00
e	1.27 BSC	
H	5.80	6.20
L	0.40	1.25
$\theta$	0°	7°

DCC  
 正式發行