

P-Channel 30V (D-S) MOSFET

GENERAL DESCRIPTION

The ME4411-G is the P-Channel logic enhancement mode power field effect transistors are produced using high cell density , DMOS trench technology. This high density process is especially tailored to minimize on-state resistance. These devices are particularly suited for low voltage application such as cellular phone and notebook computer power management and other battery powered circuits where high-side switching and low in-line power loss are needed in a very small outline surface mount package.

PIN CONFIGURATION

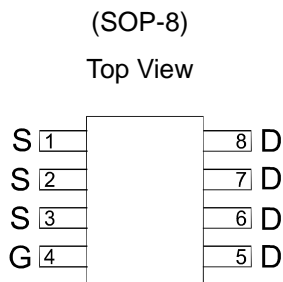

FEATURES

- $R_{DS(ON)} \leq 10m\Omega @ V_{GS} = -10V$
- $R_{DS(ON)} \leq 13m\Omega @ V_{GS} = -4.5V$
- Super high density cell design for extremely low $R_{DS(ON)}$
- Exceptional on-resistance and maximum DC current capability

APPLICATIONS

- Power Management in Note book
- Portable Equipment
- Battery Powered System
- DC/DC Converter
- Load Switch
- DSC
- LCD Display inverter

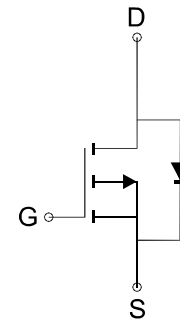

P-Channel MOSFET

Ordering Information: ME4411 (Pb-free)

ME4411-G (Green product-Halogen free)

Absolute Maximum Ratings (TA=25°C Unless Otherwise Noted)

Parameter	Symbol	Maximum Ratings	Unit
Drain-Source Voltage	V_{DS}	-30	V
Gate-Source Voltage	V_{GS}	± 20	V
Continuous DrainCurrent*	I_D	$T_A = 25^\circ C$	-12.5
		$T_A = 70^\circ C$	-10
Pulsed Drain Current	I_{DM}	-50	A
Avalanche Current	I_{AR}	-42	A
Avalanche Energy with Single Pulse(L=0.1mH)	E_{AS}	88.2	mJ
Maximum Power Dissipation*	P_D	$T_A = 25^\circ C$	2.5
		$T_A = 70^\circ C$	1.6
Operating Junction Temperature	T_J	-55 to 150	$^\circ C$
Thermal Resistance-Junction to Ambient*	$R_{\theta JA}$	50	$^\circ C/W$

*The device mounted on 1in² FR4 board with 2 oz copper

正式發行

P-Channel 30V (D-S) MOSFET

Electrical Characteristics (T_A=25°C Unless Otherwise Specified)

Symbol	Parameter	Limit	Min	Typ	Max	Unit
STATIC						
V _{(BR)DSS}	Drain-Source Breakdown Voltage	V _{GS} =0V, I _D =-250 μA	-30			V
V _{GS(th)}	Gate Threshold Voltage	V _{DS} =V _{GS} , I _D =-250 μA	-1		-3	V
I _{GSS}	Gate Leakage Current	V _{DS} =0V, V _{GS} =±20V			±100	nA
I _{DSS}	Zero Gate Voltage Drain Current	V _{DS} =-30V, V _{GS} =0V			-1	μA
R _{DS(ON)}	Drain-Source On-State Resistance ^a	V _{GS} =-10V, I _D = -13A		8.3	10	mΩ
		V _{GS} =-4.5V, I _D = -10A		10	13	
V _{SD}	Diode Forward Voltage	I _S =-2.7A, V _{GS} =0V		-0.74	1.2	V
DYNAMIC						
Q _g	Total Gate Charge	V _{DS} =-15V, V _{GS} =-10V, I _D =-13A		83.2		nC
Q _g	Total Gate Charge	V _{DS} =-15V, V _{GS} =-4.5V, I _D =-13A		41		
Q _{gs}	Gate-Source Charge			12		
Q _{gd}	Gate-Drain Charge			17.7		
R _g	Gate Resistance	V _{GS} =0V, V _{DS} =0V, f=1MHz		5.6		Ω
C _{iss}	Input capacitance	V _{DS} =-15V, V _{GS} =0V, f=1MHz		3790		pF
C _{oss}	Output Capacitance			468		
C _{rss}	Reverse Transfer Capacitance			381		
t _{d(on)}	Turn-On Delay Time	V _{DD} =-15V, R _L =15Ω I _D =-1A, V _{GEN} =-10V R _G =6Ω		48		ns
t _r	Turn-On Rise Time			20.9		
t _{d(off)}	Turn-Off Delay Time			274		
t _f	Turn-Off Fall Time			80.2		

Notes: a. Pulse test: pulse width ≤ 300us, duty cycle ≤ 2%, Guaranteed by design, not subject to production testing.

b. Matsuki Electric/ Force mos reserves the right to improve product design, functions and reliability without notice.



P-Channel 30V (D-S) MOSFET

Typical Characteristics (T_J = 25°C Noted)

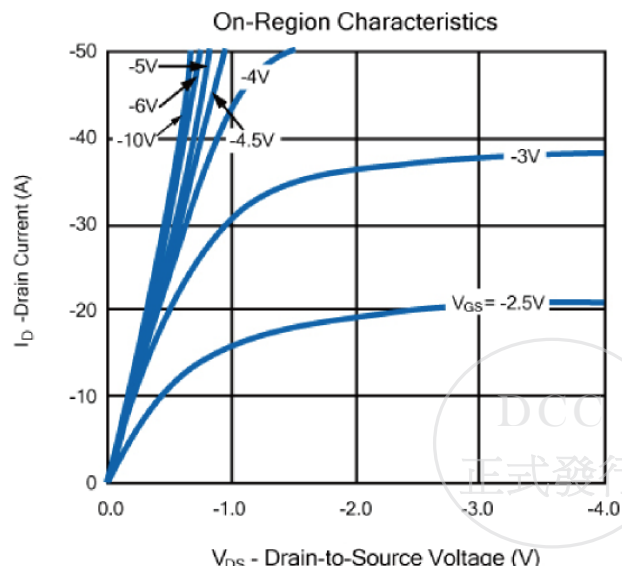
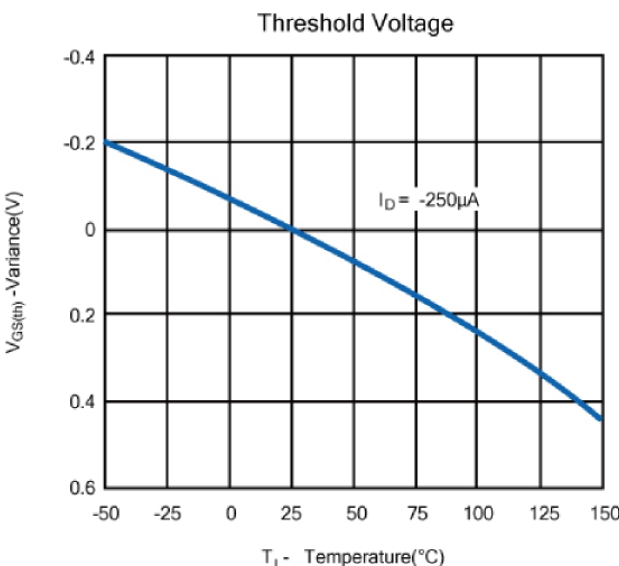
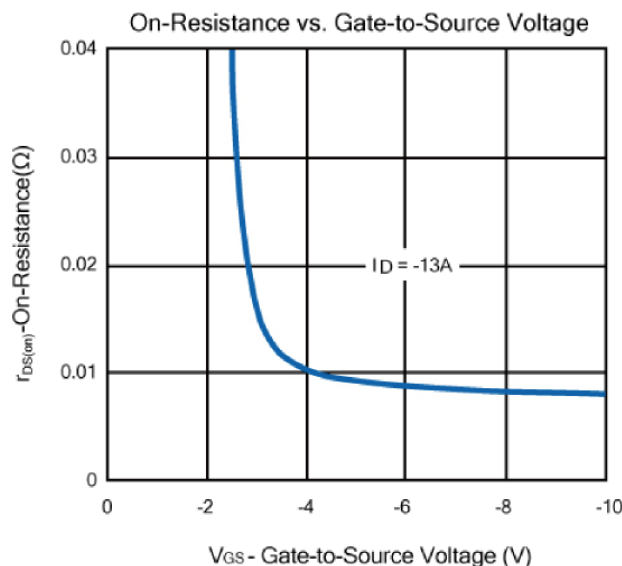
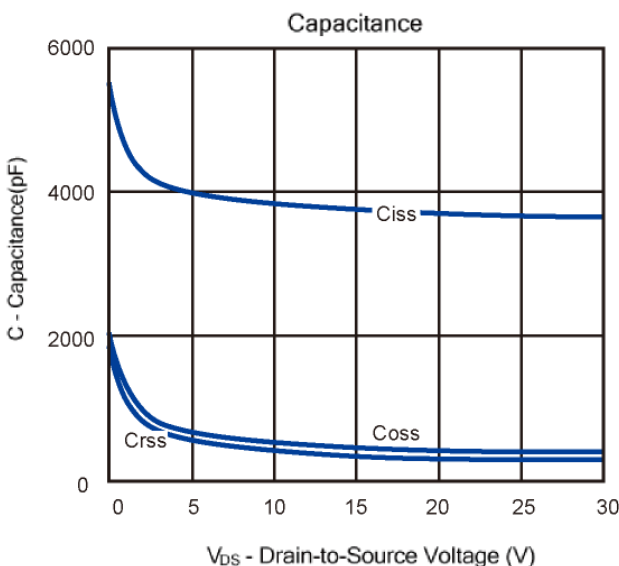
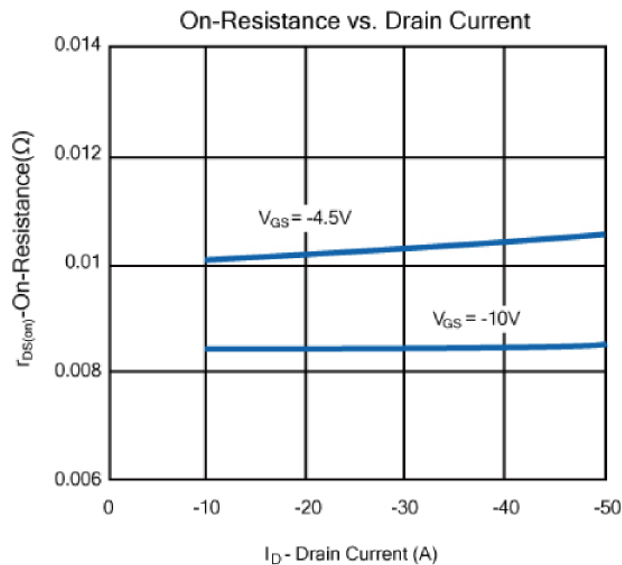
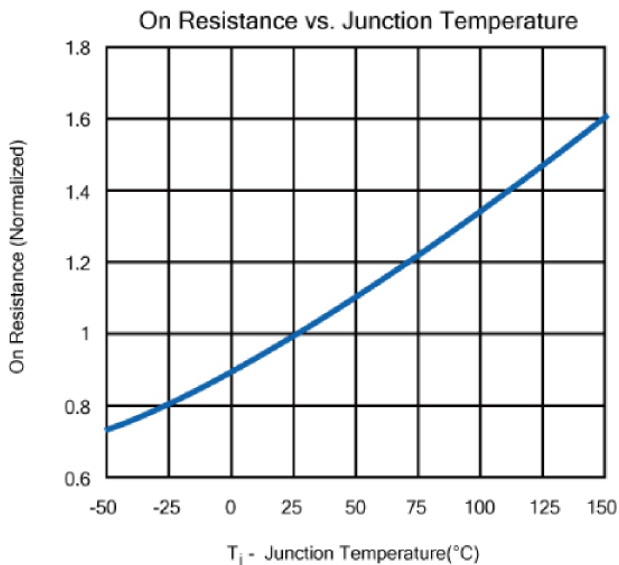

P-Channel 30V (D-S) MOSFET

Typical Characteristics (T_J =25°C Noted)

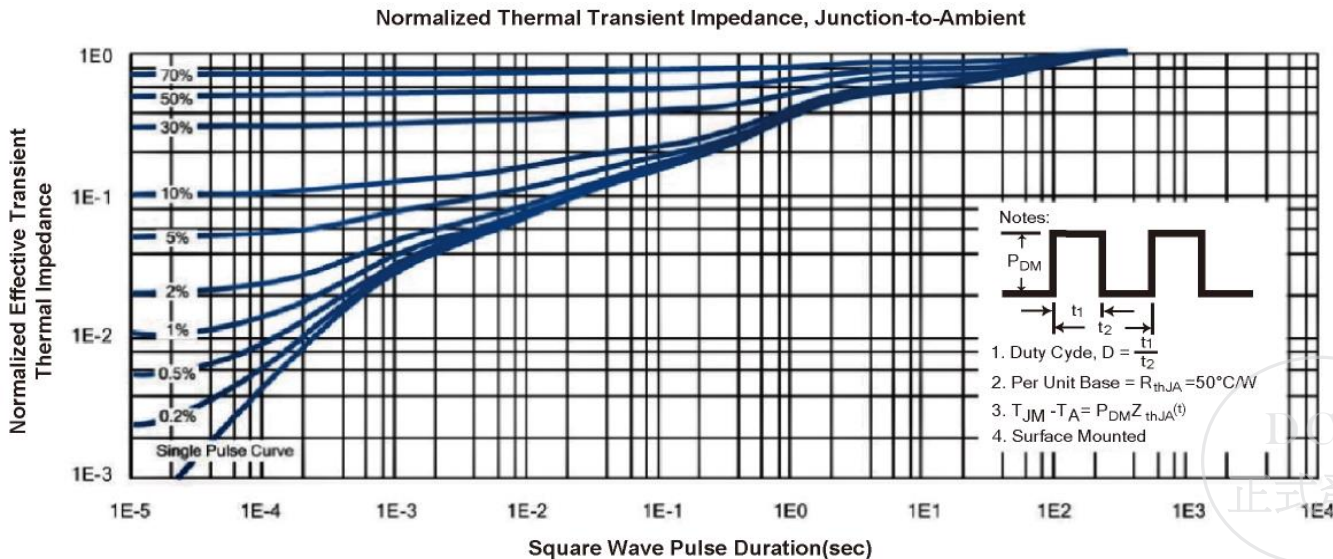
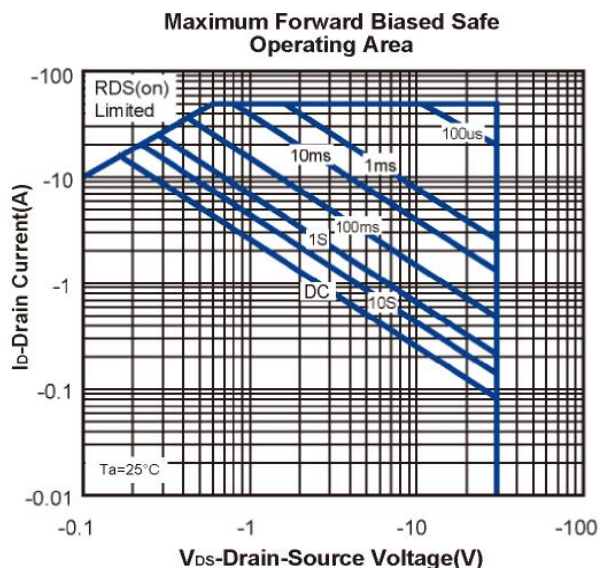
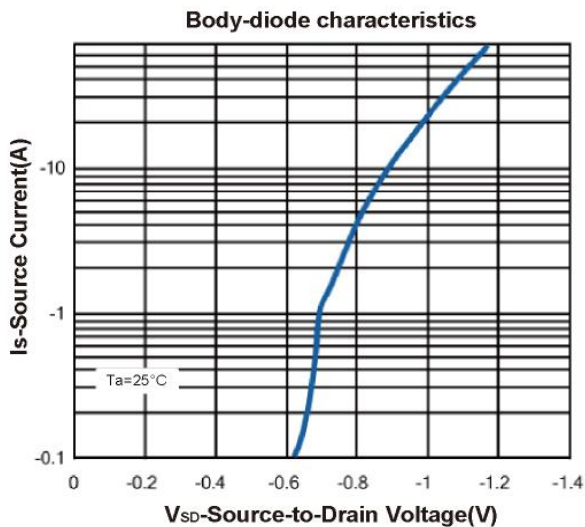
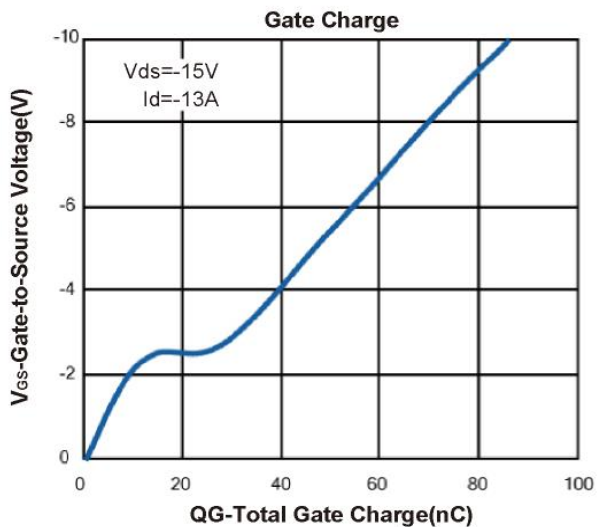

SOP-8 Package Outline

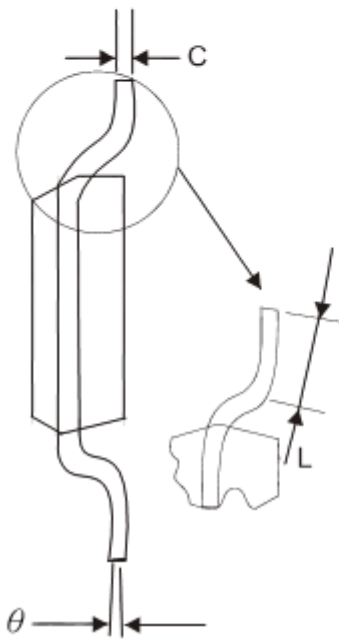
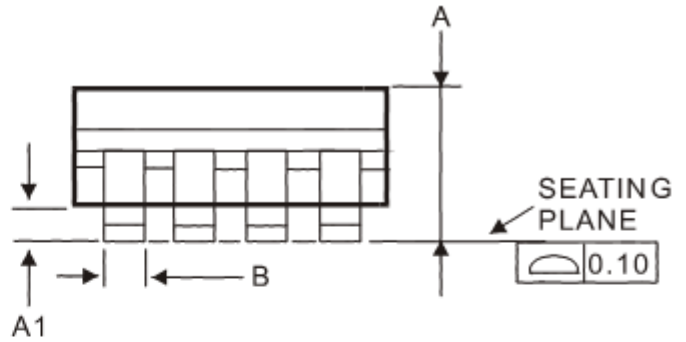
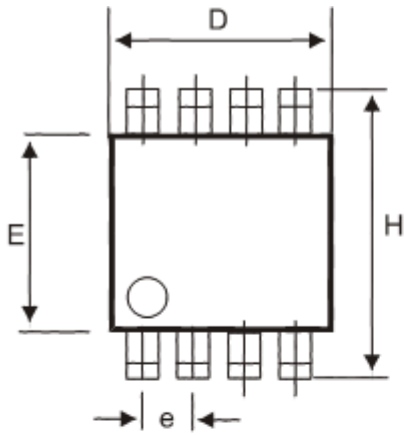

DIM	MILLIMETERS (mm)	
	MIN	MAX
A	1.35	1.75
A1	0.10	0.25
B	0.35	0.49
C	0.18	0.25
D	4.80	5.00
E	3.80	4.00
e	1.27 BSC	
H	5.80	6.20
L	0.40	1.25
θ	0°	7°

Note: 1. Refer to JEDEC MS-012AA.

2. Dimension "D" does not include mold flash, protrusions or gate burrs . Mold flash, protrusions or gate burrs shall not exceed 0.15 mm per side.

