

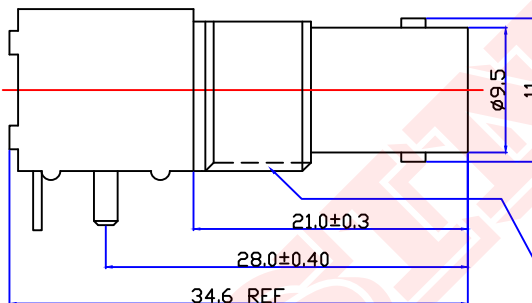

Product NO.		DOSIN-801-0038		
REV	DESCRIPTION	DWN	DATE	APPROVEN
A	First issue	CHEN	2012/11/02	John kine

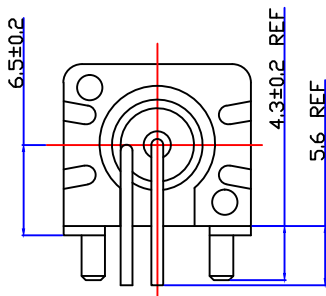

1/2-28UNEF-2A

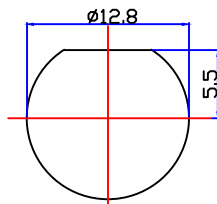
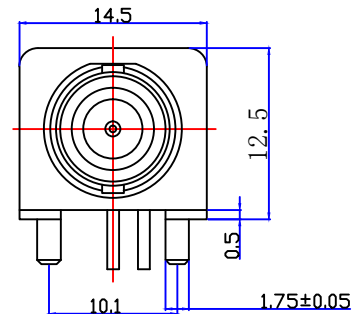

Specifications

Impedance:50 Ohms
 Frequency Range:DC~3G
 VSWR:1.3MAX
 Working Voltage:500V rms @ sea level
 Insulation Resistance:5000 Ohms min
 Temperature Range:-55°C TO +155°C
 Relative Temperature:≤95%(40° C±2° C)
 Drawings products are in line with ROHS standards

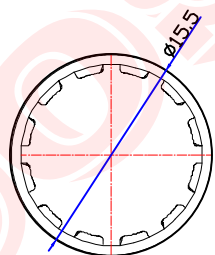
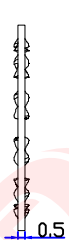

WASHER

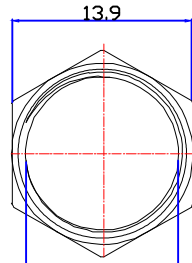

NUT

1/4-28UNEF-2B

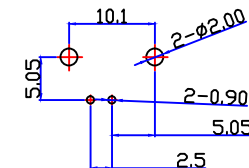

PCB

1	Body	Zinc	NI:80-120u"
2	Center contact	Brass	AU:1u"
3	Lead	Iron	AU:1u"
4	Fixed footrest	Iron	NI:80-120u"
5	Insulator	POM	White
6	Fixed mount	ABS	White
7	Washer	Iron	NI:80-120u"
8	Hex nut	Brass	NI:80-120u"
9			
10			
NO	Component Number	Material	Finish

NOTE:		Tolerance	0-6 ±0.20 6-30 ±0.30 30-120 ±0.5 Angular ±2°
DRAWN	2012/11/10	View	
Zelin. Zhang	10	UNIT	MM
CHECKED		SCALE	1:1
APPROVALS	12/04.2012		
John			

Dosin Industrial(H.K)Co.Ltd 东莞市德索五金电子制品有限公司 Dosin Hardware Electronics Co.,Ltd		E-mail:dosin2005@163.com dosin2005@dosing-china.com Web:http://www.dosinconn.com TEL:(0086)769-81153906 FAX:(0086)769-81875836	
Name: BNC WHITE JACK CONNECTOR (12.5MM)			
SIZE	Product NO.	REV	
A	DOSIN-801-0038	A	
Date	CAD FILE	SHEET: 1 OF 1	
Time	D/company drawings/BD		
2012/11/02			