

**N-Channel 40-V (D-S) MOSFET**

**GENERAL DESCRIPTION**

The ME12N04 is the N-Channel logic enhancement mode power field effect transistors are produced using high cell density, DMOS trench technology. This high density process is especially tailored to minimize on-state resistance. These devices are particularly suited for low voltage application such as cellular phone and notebook computer power management and other battery powered circuits where high-side switching, and low in-line power loss are needed in a very small outline surface mount package.

**PIN CONFIGURATION**

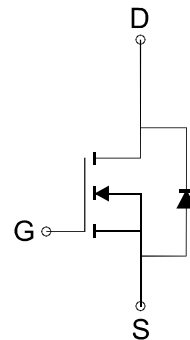
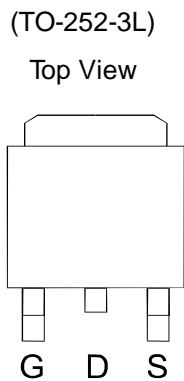

**FEATURES**

- $R_{DS(ON)}=28m\Omega@V_{GS}=10V$  (N-Ch)
- $R_{DS(ON)}=52m\Omega@V_{GS}=4.5V$  (N-Ch)
- Super high density cell design for extremely low  $R_{DS(ON)}$
- Exceptional on-resistance and maximum DC current capability

**APPLICATIONS**

- Power Management in Note book
- Portable Equipment
- Battery Powered System
- DC/DC Converter
- Load Switch
- LCD Display inverter

Ordering Information: ME12N04 (Pb-free)

ME12N04-G (Green product-Halogen free)

**Absolute Maximum Ratings (Tc=25°C Unless Otherwise Noted)**

Parameter	Symbol	Maximum Ratings	Unit
Drain-Source Voltage	$V_{DS}$	40	V
Gate-Source Voltage	$V_{GS}$	$\pm 20$	V
Continuous Drain Current	$I_D$	Tc=25°C	22
		Tc=70°C	18
Pulsed Drain Current	$I_{DM}$	80	A
Maximum Power Dissipation	$P_D$	Tc=25°C	25
		Tc=70°C	16
Operating Junction Temperature	$T_J$	-55 to 150	°C
Thermal Resistance-Junction to Ambient*	$R_{\theta JA}$	42	°C/W
Thermal Resistance-Junction to Case*	$R_{\theta JC}$	5	°C/W

\*The device mounted on 1in<sup>2</sup> FR4 board with 2 oz copper



## N-Channel 40-V (D-S) MOSFET

Electrical Characteristics (T<sub>c</sub> =25°C Unless Otherwise Specified)

Symbol	Parameter	Limit	Min	Typ	Max	Unit
<b>STATIC</b>						
V <sub>(BR)DSS</sub>	Drain-Source Breakdown Voltage	V <sub>GS</sub> =0V, I <sub>D</sub> =250 μA	40			V
V <sub>GS(th)</sub>	Gate Threshold Voltage	V <sub>DS</sub> =V <sub>GS</sub> , I <sub>D</sub> =250 μA	1		3	V
I <sub>GSS</sub>	Gate Leakage Current	V <sub>DS</sub> =0V, V <sub>GS</sub> =±20V			±100	nA
I <sub>DSS</sub>	Zero Gate Voltage Drain Current	V <sub>DS</sub> =40V, V <sub>GS</sub> =0V			1	μA
R <sub>DS(ON)</sub>	Drain-Source On-State Resistance <sup>a</sup>	V <sub>GS</sub> =10V, I <sub>D</sub> = 12A		22	28	mΩ
		V <sub>GS</sub> =4.5V, I <sub>D</sub> = 6A		40	52	
V <sub>SD</sub>	Diode Forward Voltage	I <sub>S</sub> =1.7A, V <sub>GS</sub> =0V		0.8	1.2	V
<b>DYNAMIC</b>						
Q <sub>g</sub>	Total Gate Charge	V <sub>DS</sub> =20V, V <sub>GS</sub> =10V, I <sub>D</sub> =12A		15		nC
Q <sub>g</sub>	Total Gate Charge	V <sub>DS</sub> =20V, V <sub>GS</sub> =4.5V, I <sub>D</sub> =12A		7		
Q <sub>gs</sub>	Gate-Source Charge			4		
Q <sub>gd</sub>	Gate-Drain Charge			3.5		
C <sub>iss</sub>	Input capacitance	V <sub>DS</sub> =20V, V <sub>GS</sub> =0V, f=1MHz		539		pF
C <sub>oss</sub>	Output Capacitance			75		
C <sub>rss</sub>	Reverse Transfer Capacitance			23		
td(on)	Turn-On Delay Time	V <sub>DS</sub> =15V, R <sub>L</sub> =15Ω I <sub>D</sub> =1A, V <sub>GS</sub> =10V, R <sub>G</sub> =6Ω		13		ns
t <sub>r</sub>	Turn-On Rise Time			11		
td(off)	Turn-Off Delay Time			37		
t <sub>f</sub>	Turn-Off Fall Time			4		

Notes:a. Pulse test; pulse width ≤ 300us, duty cycle ≤ 2%

b. Matsuki Electric/ Force mos reserves the right to improve product design, functions and reliability without notice.



**N-Channel 40-V (D-S) MOSFET**

**Typical Characteristics (T<sub>J</sub> = 25°C Noted)**

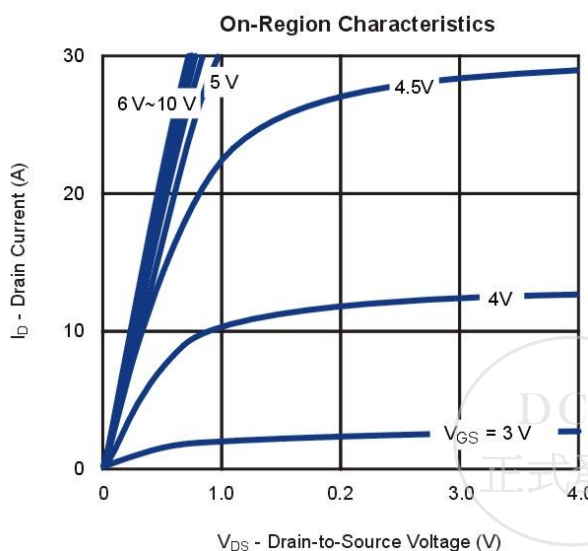
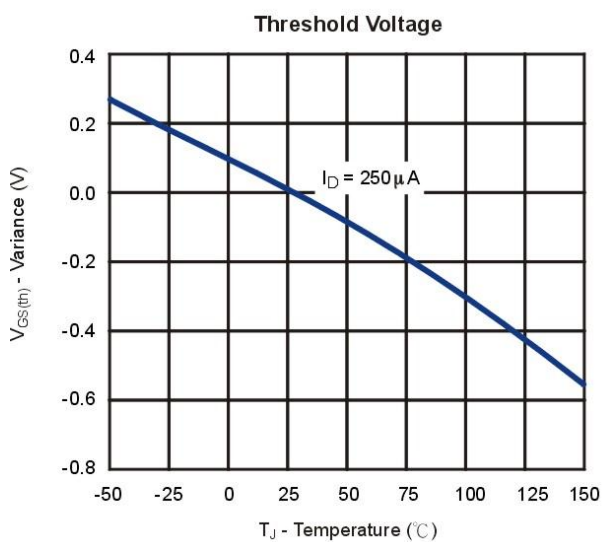
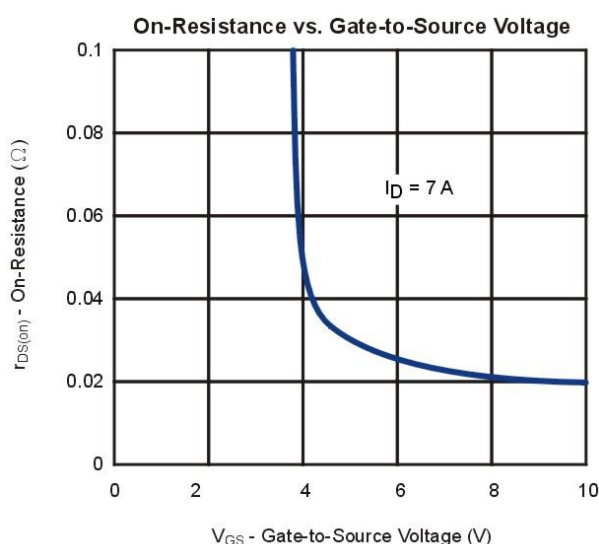
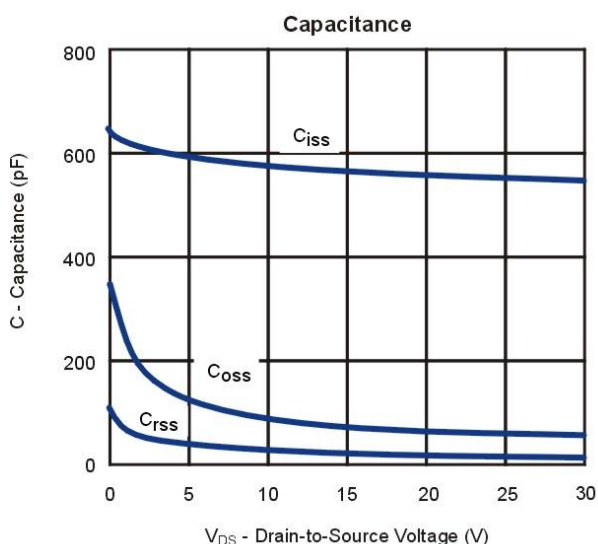
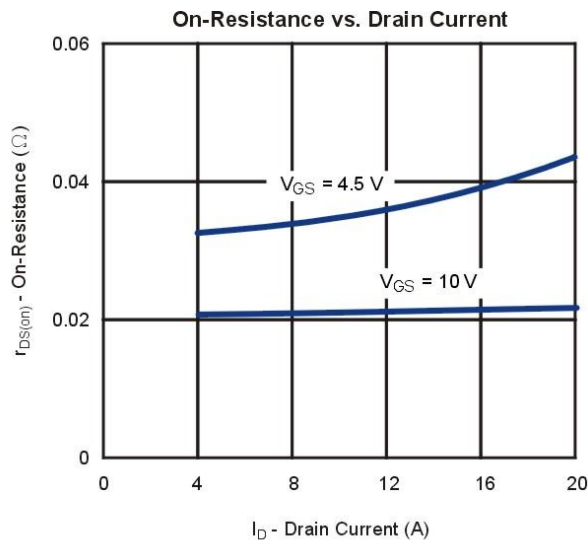
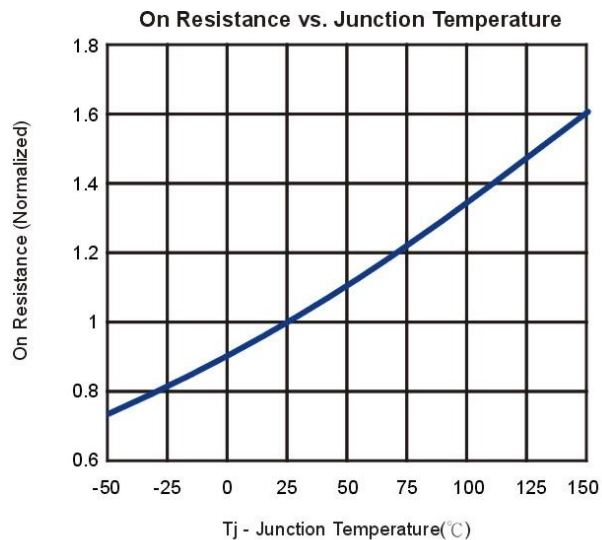

**N- Channel 40-V (D-S) MOSFET**

**Typical Characteristics (T<sub>J</sub> = 25°C Noted)**

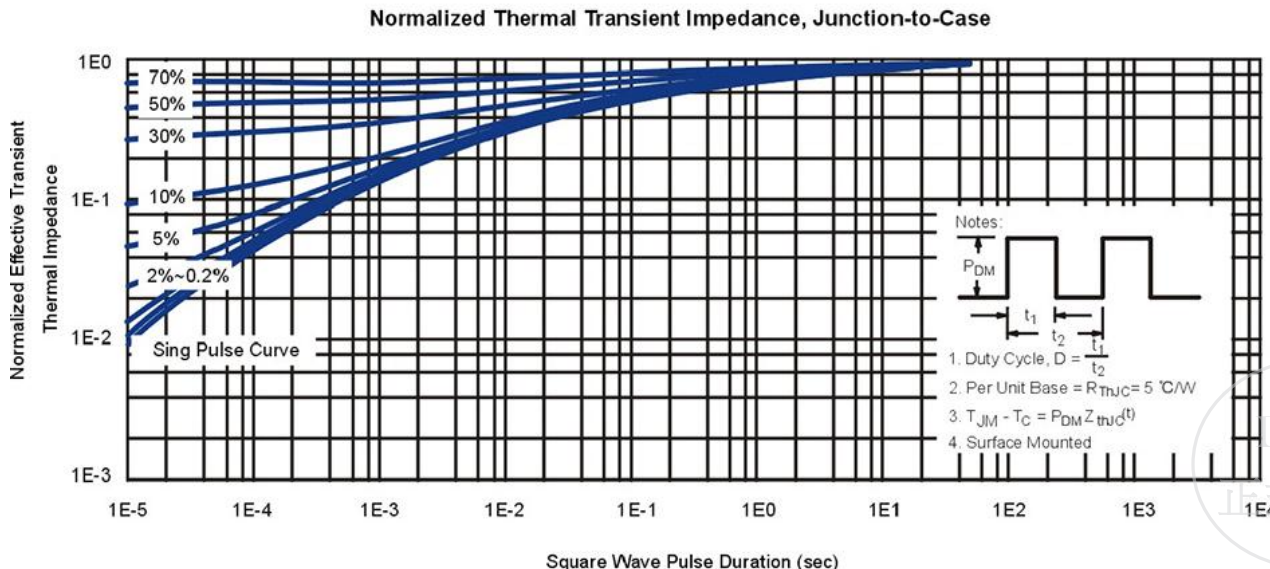
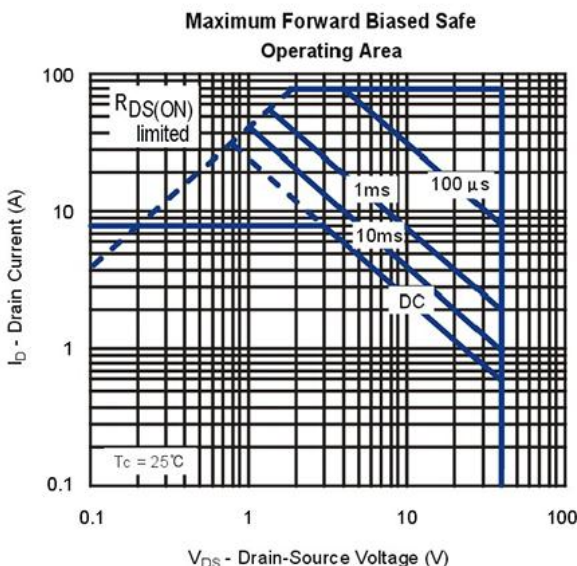
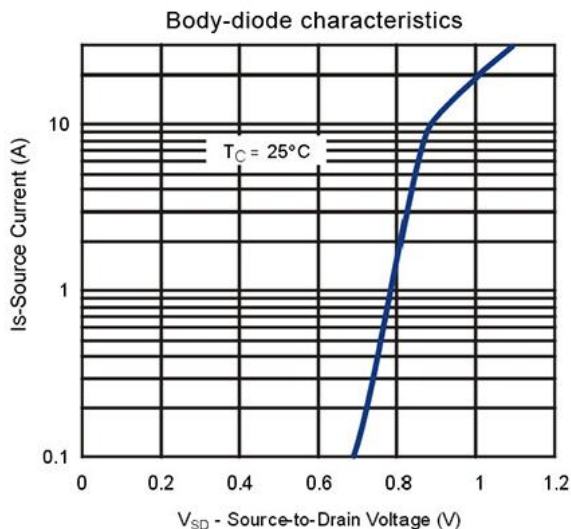
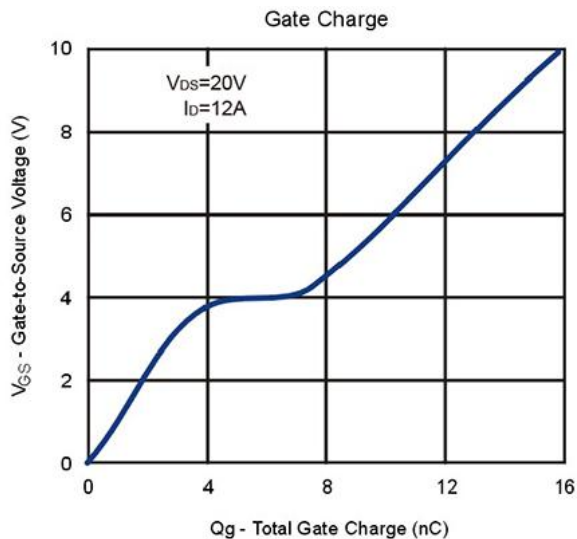

## TO-252-3L Package Outline

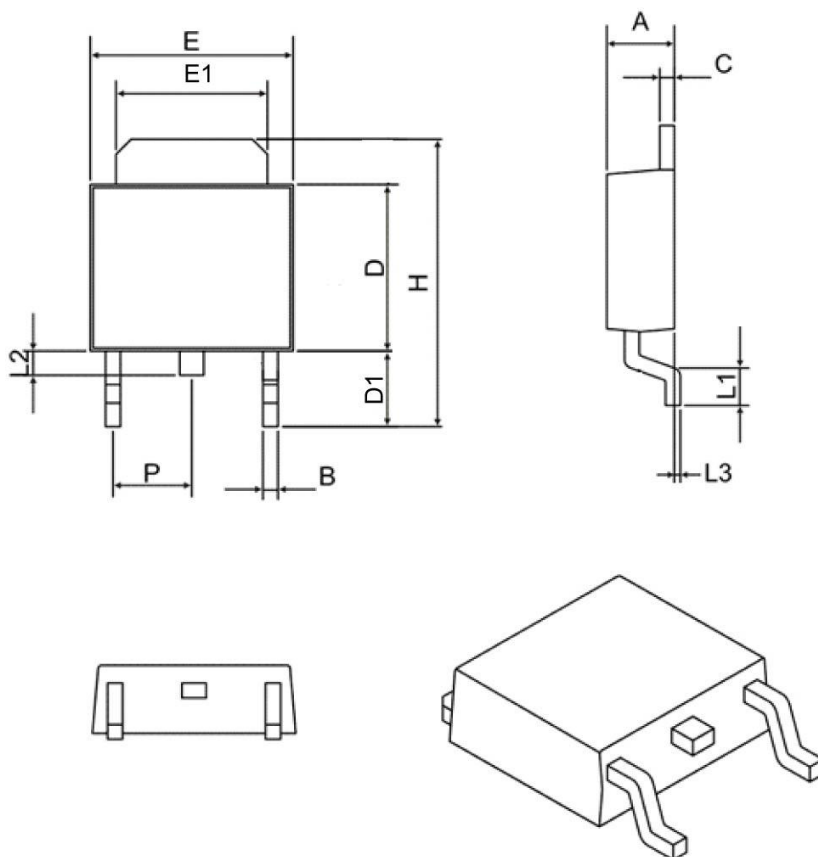

SYMBOL	MIN	MAX
A	2.10	2.50
B	0.40	0.90
C	0.40	0.90
D	5.30	6.30
D1	2.20	2.90
E	6.30	6.75
E1	4.80	5.50
L1	0.90	1.80
L2	0.50	1.10
L3	0.00	0.20
H	8.90	10.40
P	2.30 BSC	

DCC  
 正式發行