

承認書

SPECIFICATION FOR APPROVA

<i>CUSTOMER:</i>		
<i>CUSTOMER P/N:</i>		
<i>CUSTOMER PART NO:</i>		
<i>DESCRIPTION:</i>	<i>SMD INDUCTOR</i>	
<i>PRODUCTS NO:</i>	<i>BCIH11740HC-R15M</i>	
<i>FIRST DATE:</i>	<i>2019-10-23</i>	<i>BC REV: X1</i>
<i>DATE:</i>	<i>2019-10-23</i>	

<i>PURCHASER CONFIRMED</i>		
<i>APPROVAL BY</i>	<i>CHECK BY</i>	<i>DRAWN BY</i>

<i>REMARK</i>

<i>PROVIDER ENGINEER DEPT.</i>		
<i>APPROVAL BY</i>	<i>CHECK BY</i>	<i>DRAWN BY</i>
Ouyang weijun	Xuqiuyue	chenlinli

CHENG

誠陽實業有限公司

TAIPEI OFF ICE TAIWAN CHENG YANG COMPONENT CORP

2F-1, NO. 176, Chine-Yi Road., Zhonghe District, New Taipei City, TAIWAN(R.O.C)

新北市中和區建一路176號2樓之一

POSTAL CODE: 23500

TEL NO.:+886-2- 8228-0930 FAX NO.:+886-2-8228-0929 E-mail:h21803@ms29.hinet.net



寶誠電子有限公司

CHINA FACTORY ZHUHAI BAO CHENG ELECTRONICSCO.,LTD

Guan Tang Industrial Park, Tang Jia Wan Town, Zhuhai City, Guangdong Province, CHINA

中國廣東省珠海市塘家灣鎮官塘工業區

POSTAL CODE: 519085

TEL NO:86-756-3383187 FAX NO:86-756-3380704 E-mail: baocheng@baocheng.biz

CHENG

昆山誠陽電子有限公司

CHINA FACTORY KUNSHAN CHENG YANG ELECTRONICSCO.,LTDP

江蘇省昆山市高科技工業園區強安路35號

POSTAL CODE: 215300

TEL NO:86-512-57823500 FAX NO:86-512-57823503 E-mail: kscy@taiwan-chengyang.com.tw

SPECIFICATION FOR APPROVAL

DATE: 2019-10-23

CUSTOMER:	CUSTOMER PART NO:	FIRST DATE:
		2019-10-23
DESCRIPTION: SMD INDUCTOR	PRODUCTS NO: BCIH11740HC-R15M	BC REV: X1

1.CONFIGURATION DIMENSIONS

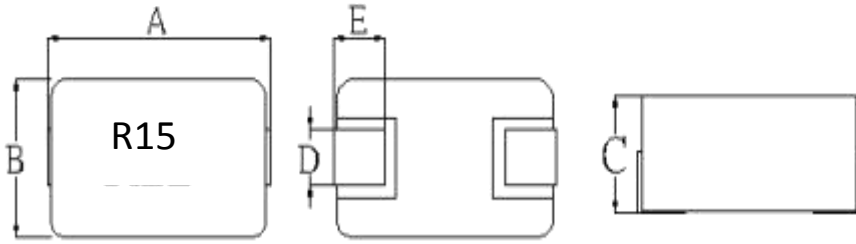

DIMENSIONS (UNIT:mm)

- A: 10.50 ±0.8
- B: 6.90 ±0.5
- C: 4.00 Max
- D: 3.00 ±0.5
- E: 2.00 ±0.5

Marking: 喷印黑色

2.RECOMMEND LAND PATTERN DIMENSIONS

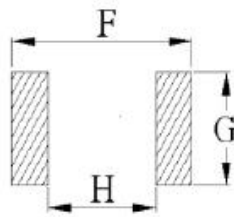

- F: 12.50
- G: 3.50
- H: 6.50

3.ELECTRICAL CHARACTER

Part Number	Inductance (uH)		R _{dc} (m Ω)	⁽⁵⁾ (I _{rms})(A) Heat Rating Current		⁽⁶⁾ (I _{sat})(A) Saturation Current	
	200kHz/0.25v/0A.		±5%	Typical		Typical	
BCIH11740HC-R15M	0.15	± 20%	0.68	40.00	ΔT ≤ 40°C	70.00	ΔL ≤ 30%

A _{dc}	0A	10A	20A	30A	40A	45A	50A	55A	60A	65A	70A	75A
L(0.15uH)	0.145	0.144	0.138	0.133	0.128	0.125	0.123	0.120	0.115	0.110	0.107	0.106
ΔT(°C)	0.00	0.80	3.80	9.50	18.20	23.70	30.00	37.00	45.10	54.40	56.00	61.50

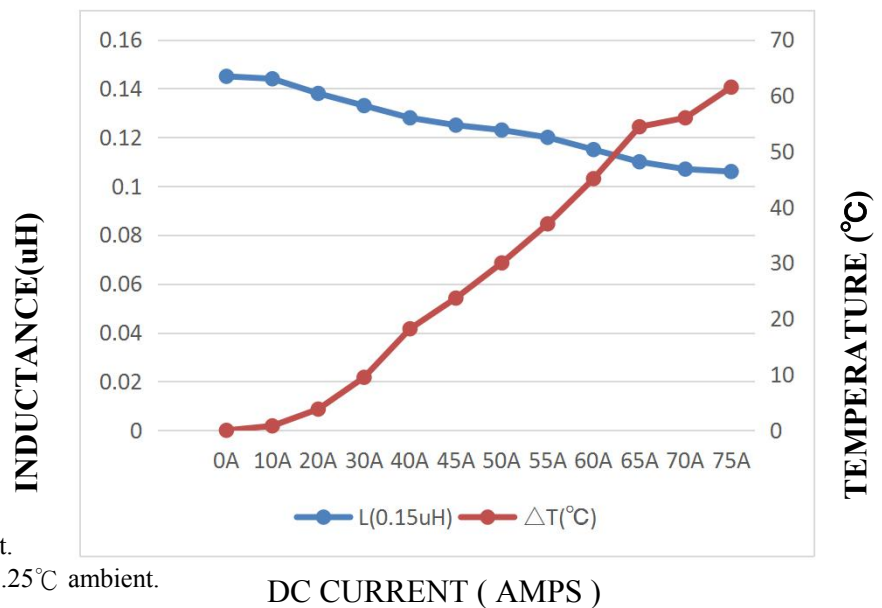

- (1) Tolerance of Inductance: M=±20%.
- (2) All test data is referenced to 25°C ambient.
- (3) Inductance is measured 200kHz/0.25v/0A.25°C ambient.
- (4) Operating Temperature Range -40°C to +125°C.
- (5) DC current (I_{rms}) (A) that will cause an Approxim ΔT ≤ 40°C
- (6) DC current (I_{sat}) (A) that will cause L0 to drop approximate ΔL ≤ 30%
- (7) The part Temperature (ambient + temp rise) should not exceed 125°C under worst case operating conditions.
Circuit design, component placement, PWB trace size and thickness, airflow and other cooling provisions all affect the part temperature Part temperature should be verified in the end application.

※I_{rms} : Heat Rating Current DC Amps.

※I_{sat} : Saturation Current DC Amps.

CUSTOMER:	CUSTOMER PART NO:	FIRST DATE:
DESCRIPTION: SMD INDUCTOR	PRODUCTS NO: BCIH11740HC-R15M	2019-10-23 BC REV: X1

4.PACKAGING INFORMATION

(1) Tape Dimension / Packaging Quantity

Reel Dimensions

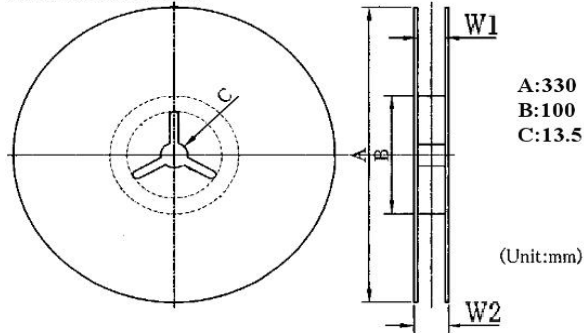

Tape Dimensions

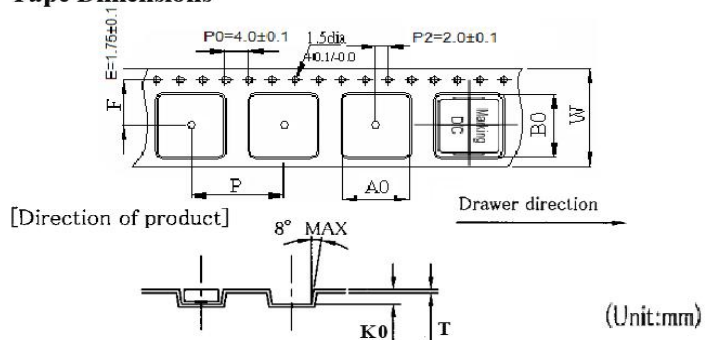

DIMENSIONS (UNIT:mm)

- A: 330.0 ±2.00
- B: 100.0 ±0.50
- C: 13.5 ±0.50
- W1: 24.80 ±0.30
- W2: 29.00 ±0.50
- Q`TY: 1,000 PCS

DIMENSIONS (UNIT:mm)

- W: 24.00 ±0.30
- A0: 7.60 ±0.10
- B0: 12.00 ±0.10
- K0: 5.40 ±0.10
- P: 12.00 ±0.10
- F: 11.50 ±0.10
- T: 0.40 ±0.05

(2) Tearing Off Force

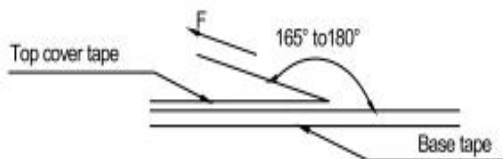

Room Temp. (°C)	Room Humidity (%)	Room atm (hPa)	Tearing Speed mm/min
5~35	45~85	860~1060	300

The force tearing off cover 10 to 130 grams (0.1N to 1.3N) in the arrow direction under the following conditions.

● Storage conditions/Note things

(1) Storage temperature and humidity conditions :

1. Product packing with Carrier tape: +5°C~+40°C and less than 60% RH.
2. Product alone: -20°C~+60°C and less than 60% RH.

(2) Products should be used within 6 months.

(3) The packaging material should be kept where no chlorine or sulfur exists in the air.

(4) Do not touch the electrodes (soldering terminals) with fingers as this may lead to deterioration of solder ability

(5) The use of tweezers or vacuum pick-ups is strongly recommended for individual components.

(6) Bulk handling should ensure that abrasion and mechanical shock are minimized.

SAMPLE ACKNOWLEDGE CHANGE RESUME

DATE: 2019-10-23

CUSTOMER:	CUSTOMER PART NO:	FIRST DATE: 2019-10-23
DESCRIPTION: SMD INDUCTOR	PRODUCTS NO: BCIH11740HC-R15M	BC REV: X1

REV		Change content	Change reason	Modify	Date
X1	00	首次	首次送样	chenlinli	2019-10-23

TEST DATA

DATE: 2019-10-23

CUSTOMER:	CUSTOMER PART NO:	FIRST DATE: 2019-10-23
DESCRIPTION: SMD INDUCTOR	PRODUCTS NO: BCIH11740HC-R15M	BC REV: X1

(1) TEST DATA FOR SAMPLE

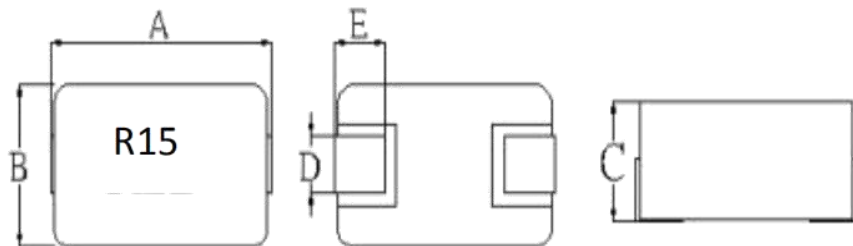

LOT NO.		
DIMENSIONS (UNIT:mm)		
A	10.50	±0.8
B	6.90	±0.5
C	4.00	Max
D	3.00	±0.5
E	2.00	±0.5

TEST ITEM	SPEC	TEST CONDITION
1 Inductance (uH)	0.15 ± 20%	200kHz/0.25v/0A.
2 Rdc (mΩ)	0.68 ±5%	
3 (6) (Isat)(A) Saturation Current DC Amps	70.00 ΔL ≤ 30%	
4 (5) (Irms)(A) Heat Rating Current DC Amp	40.00 ΔT ≤ 40℃	

MEAS ITEM	A	B	C	D	E			1	2	3
SUGGEST	10.50	6.90	4.00	3.00	2.00			0.15	0.68	70.00
	±0.8	±0.5	Max	±0.5	±0.5			± 20%	±5%	ΔL ≤ 30%
1	7.35	11.01	3.87	4.10	2.0			0.121	0.70	79%
2	7.30	11.07	3.78	4.10	2.0			0.126	0.68	82%
3	7.32	11.08	3.76	4.10	2.0			0.146	0.69	81%
4	7.33	11.06	3.79	4.10	2.0			0.142	0.68	82%
5	7.30	11.07	3.78	4.10	2.0			0.134	0.71	81%
6	7.30	11.08	3.78	4.10	2.0			0.128	0.68	80%
7	7.31	11.07	3.76	4.10	2.0			0.141	0.69	79%
8	7.32	11.08	3.77	4.10	2.0			0.162	0.68	79%
9	7.31	11.07	3.75	4.10	2.0			0.148	0.69	78%
10	7.32	11.05	3.76	4.10	2.0			0.146	0.68	79%
11										
12										
13										
14										
15										
max	7.35	11.08	3.87					0.16	0.71	82.0%
min	7.30	11.01	3.75					0.12	0.68	78.0%
σ	0.015	0.020	0.032					0.012	0.010	0.013
X	7.32	11.06	3.78					0.14	0.69	80.0%
Cpk	70.91	69.06	2.27					1.16	0.27	1719.29

2. TEST CONDITION TEMP. 25℃ R.H. 65%		APPROVED BY
3. TEST INSTRUMENTS <input type="checkbox"/> HP-4284A METER <input type="checkbox"/> CH-3305 METER <input checked="" type="checkbox"/> HP-4285A METER <input type="checkbox"/> CD1068+CD1320 METER <input type="checkbox"/> HP-4191A METER <input type="checkbox"/> VR113+VR712 METER <input type="checkbox"/> CH101 LCR,METER <input type="checkbox"/> WK3260B+WK3265B METER <input checked="" type="checkbox"/> VR116+VR7220 METI <input type="checkbox"/> VR562 METER <input type="checkbox"/> CH-3200 METER <input checked="" type="checkbox"/> CH-502B DCR METER <input type="checkbox"/> CH-310 METER		Ouyang weijun
		CHECKED BY
		Xuqiuyue
		DRAWN BY
	chenlinli	

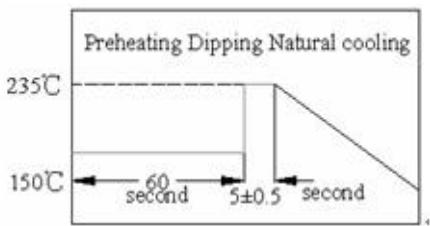
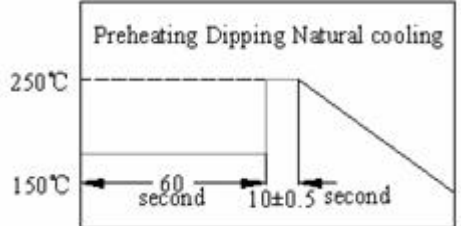
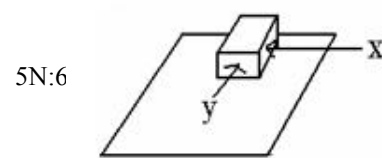
Operation Temperature	-40°C to +125°C (Includes temperature when the coil is heated)
External Appearance	On visual inspection, the coil has no external defects.
Solder Ability Test	<p>More than 90% of terminal electrode should be covered with solder.</p> <p>1 After fluxing, component shall be dipped in a dipped in a melted.</p> <p>Solder:bath at 235°C ± 5°C for 5 ± 0.5seconds</p> 
Heat endurance of Solderin	<p>1.Components should have not evidence of electrical and mechanical damage.</p> <p>2.Inductance: within±10% of initial value.</p> <p>3.Impedance: within±10% of initial value.</p> <ul style="list-style-type: none"> ●Preheat: 150±5°C 60seconds. ●Solder temperature: 250±5°C. ●Flux: rosin. ●Dip time:10±0.5seconds. 
Terminal Strength	<p>After soldering of X,Y withstanding at below conditions .The terminal should not Peel off. (Refer to figure at below)</p> 
Insulating Resistance	Over 100MΩ at 100V D.C. between coil and core.
Dielectric Strength	No dielectric breakdown at 30V D.C. for 1 minute between coil and core.
VibrationTest	Inductance deviation within +10% after vibration for 1 hour. In each of three orientations at sweep vibration(10~55~10HZ)with 1.5mmP-P amplitudes
Drop test	Inductance deviation within +10% after being dropped once with 981m/s2 (100G) shock Attitude upon a rubber block method shock testing machine, in three different orientations
<p>© Application Notice/Handling</p> <p>1. Storage Conditions</p> <p>1. Storage Conditions</p> <p>To maintain the solder ability of terminal electrodes:</p> <p>(1) Temperature and humidity conditions: less than 40°C and 70% RH.</p> <p>(2) Products should be used within 6 months.</p> <p>(3) The packaging material should be kept where no chlorine or sulfur exists in the air.</p> <p>2. Handling</p> <p>(1) Do not touch the electrodes(soldering terminals)with fingers as this may lead to deterioration of solderability.</p> <p>(2) The use of tweezers or vacuum pick-ups is strongly recommended for individual components.</p> <p>(3) Bulk handling should ensure that abrasion and mechanical shock are minimized.</p>	

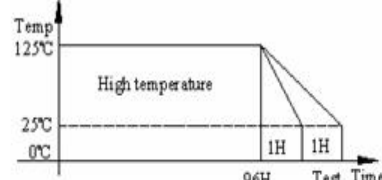
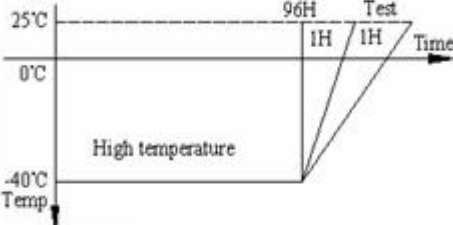
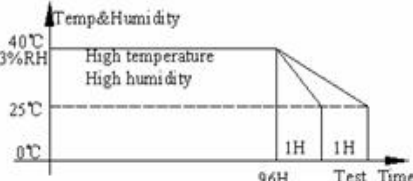
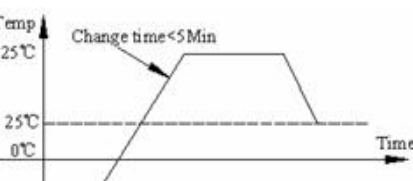
TEST	Required Characteristics	Test Method/Condition
<p>High Temperature Storage Test</p> <p>Reference documents: MIL-STD-202G Method108A</p>	<p>1. No case deformation or change in appearance</p> <p>2. $\Delta L/L \leq 10\%$</p> <p>3. $\Delta Q/Q \leq 30\%$</p> <p>4. $\Delta DCR/DCR \leq 10\%$</p>	 <p>Temperature: $125^{\circ}\text{C} \pm 2^{\circ}\text{C}$ Time: 96 ± 2 hours. Tested not less than 1 hour, nor more than 2 hours at room.</p>
<p>Low Temperature Storage Test</p> <p>Reference documents: IEC 68-2-1A 6.1 6.2</p>	<p>1. No case deformation or change in appearance</p> <p>2. $\Delta L/L \leq 10\%$</p> <p>3. $\Delta Q/Q \leq 30\%$</p> <p>4. $\Delta DCR/DCR \leq 10\%$</p>	 <p>Tested not less than 1 hour, nor more than 2 hours at room.</p>
<p>Humidity Test</p> <p>Reference documents: MIL-STD-202G Method103B</p>	<p>1. No case deformation or change in appearance</p> <p>2. $\Delta L/L \leq 10\%$</p> <p>3. $\Delta Q/Q \leq 30\%$</p> <p>4. $\Delta DCR/DCR \leq 10\%$</p>	 <p>1. Dry oven at a temperature of $40^{\circ}\text{C} \pm 2^{\circ}\text{C}$ for 96hours</p> <p>2. Measurements At the end of this period</p> <p>3. Exposure: Temperature: $40^{\circ}\text{C} \pm 2^{\circ}\text{C}$. Humidity: 93 ± 2hoysrs.</p> <p>4. Tested while the chamber.</p> <p>5. Tested not less than 1 hour. Nor more than 2 hours at room temperature.</p>
<p>Thermal Shock Test</p> <p>Reference documents: MIL-STD-202G Method107G</p>	<p>1. No case deformation or change in appearance</p> <p>2. $\Delta L/L \leq 10\%$</p> <p>3. $\Delta Q/Q \leq 30\%$</p> <p>4. $\Delta DCR/DCR \leq 10\%$</p>	 <p>First -40°C for 30 Minutes, last 125°C for 30 Minutes as 1 cycle. Go through 20 cycles.</p>

■ Application Notice/Handling

- (1) Temperature and humidity conditions : less than 40°C and 70% RH.
- (2) Products should be used within 6 months.
- (3) The packaging material should be kept where no chlorine or sulfur exists in the air.
- (4) Do not touch the electrodes (soldering terminals) with fingers as this may lead to deterioration of solder ability
- (5) The use of tweezers or vacuum pick-ups is strongly recommended for individual components.
- (6) Bulk handling should ensure that abrasion and mechanical shock are minimized.

TYPICAL WAVE SOLDER PROFILE FOR LEADED AND LEAD-FREE THROUGH-HOLE PACKAGES

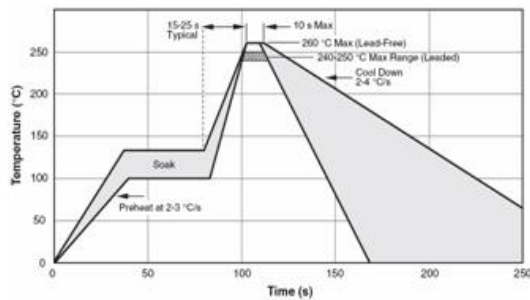

TYPICAL IR REFLOW PROFILE FOR LEADED AND LEAD-FREE SURFACE MOUNT PACKAGES

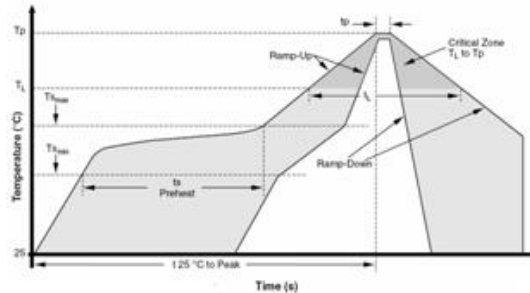

IPC/JEDEC J-STD-020C, Figure 5-1

Profile Feature	Sn-Pb Eutectic Assembly	Pb-Free Assembly
Average Ramp-Up Rate (Ts _{max} to Tp)	3 °C/second max.	3 °C/second max.
Preheat		
± Temperature Min (Ts _{min})	100 °C	150 °C
± Temperature Max (Ts _{max})	150 °C	200 °C
± Time (ts _{min} to ts _{max})	60-120 seconds	60-180 seconds
Time maintained above:		
± Temperature (T _L)	183 °C	217 °C
± Time (t _L)	60-150 seconds	60-150 seconds
Peak/Classification Temperature (Tp)	See Table 4.1	See Table 4.2
Time within 5 °C of actual Peak Temperature (tp)	10-30 seconds	20-40 seconds
Ramp-Down Rate	6 °C/second max.	6 °C/second max.
Time 25 °C to Peak Temperature	6 minutes max.	8 minutes max.

Table 4. Classification Reflow Profiles (per IPC/JEDEC J-STD-020C, Table 5.2)

Note 1: All temperatures refer to topside of the package, measured on the package body surface.

Package Thickness	Volume mm ³ <350	Volume mm ³ ≥350
<2.5 mm	240 +0/-5 °C	225 +0/-5 °C
≥2.5 mm	225 +0/-5 °C	225 +0/-5 °C

Table 5. SnPb Eutectic Process – Package Peak Reflow Temperatures (per IPC/JEDEC J-STD-020C, Table 4.1)

Package Thickness	Volume mm ³ <350	Volume mm ³ 350-2000	Volume mm ³ >2000
<1.6 mm	260 + 0 °C *	260 + 0 °C *	260 + 0 °C *
1.6 mm - 2.5 mm	260 + 0 °C *	250 + 0 °C *	245 + 0 °C *
≥2.5 mm	250 + 0 °C *	245 + 0 °C *	245 + 0 °C *

* Tolerance: Process compatibility is up to and including the stated classification temperature (this means Peak reflow temperature + 0 °C. For example 260 °C + 0 °C) at the rated MSL level.

Table 6. Pb-free Process – Package Classification Reflow Temperatures (per IPC/JEDEC J-STD-020C, Table 4.2)

Note 1: The profiling tolerance is + 0 °C, -X °C (based on machine variation capability) whatever is required to control the profile process but at no time will it exceed -5 °C. Process compatibility at the peak reflow profile temperatures as defined in Table 4.2.

Note 2: Package volume excludes external terminals (balls, bumps, lands, leads) and/or nonintegral heat sinks.

Note 3: The maximum component temperature reached during reflow depends on package thickness and volume. The use of convection reflow processes reduces the thermal gradients between packages. However, thermal gradients due to differences in thermal mass of SMD packages may still exist.

Note 4: Components intended for use in a "lead-free" assembly process shall be evaluated using the "lead-free" classification temperatures and profiles defined in Tables 4.1, 4.2 and 5.2 whether or not lead free.