

IHM-A 模块 采用第四代沟槽栅/场终止IGBT4和第三代发射极控制二极管  
 IHM-A module with Trench/Fieldstop IGBT4 and Emitter Controlled 3 diode

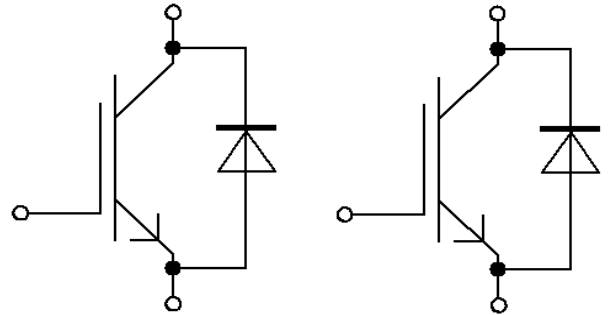

$V_{CES} = 1700V$   
 $I_{C\ nom} = 800A / I_{CRM} = 1600A$

### 潜在应用

- 中压变流器
- 大功率变流器
- 牵引变流器
- 电机传动
- 风力发电机

### Potential Applications

- Medium voltage converters
- High power converters
- Traction drives
- Motor drives
- Wind turbines

### 电气特性

- $T_{vj\ op} = 150^{\circ}C$
- 低  $V_{CEsat}$
- 增大的二极管针对反馈运行模式
- 提高工作结温  $T_{vj\ op}$

### Electrical Features

- $T_{vj\ op} = 150^{\circ}C$
- Low  $V_{CEsat}$
- Enlarged diode for regenerative operation
- Extended operating temperature  $T_{vj\ op}$

### 机械特性

- 4 kV 交流 1分钟 绝缘
- 标准封装
- 碳化硅铝 (AlSiC) 基板提供更高的温度循环能力
- 高功率密度
- 高功率循环和温度循环能力

### Mechanical Features

- 4 kV AC 1min insulation
- Standard housing
- AlSiC base plate for increased thermal cycling capability
- High power density
- High power and thermal cycling capability

## Module Label Code

Barcode Code 128



DMX - Code



### Content of the Code

Content of the Code	Digit
Module Serial Number	1 - 5
Module Material Number	6 - 11
Production Order Number	12 - 19
Datecode (Production Year)	20 - 21
Datecode (Production Week)	22 - 23

## IGBT, 逆变器 / IGBT, Inverter

## 最大额定值 / Maximum Rated Values

集电极 - 发射极电压 Collector-emitter voltage	$T_{vj} = 25^{\circ}\text{C}$	$V_{CES}$	1700	V
连续集电极直流电流 Continuous DC collector current	$T_C = 80^{\circ}\text{C}, T_{vj\max} = 150^{\circ}\text{C}$ $T_C = 25^{\circ}\text{C}, T_{vj\max} = 150^{\circ}\text{C}$	$I_{CDC}$ $I_C$	800 1200	A A
集电极重复峰值电流 Repetitive peak collector current	$t_P = 1\text{ ms}$	$I_{CRM}$	1600	A
栅极 - 发射极峰值电压 Gate-emitter peak voltage		$V_{GES}$	+/-20	V

## 特征值 / Characteristic Values

			min.	typ.	max.	
集电极 - 发射极饱和电压 Collector-emitter saturation voltage	$I_C = 800\text{ A}$ $V_{GE} = 15\text{ V}$	$T_{vj} = 25^{\circ}\text{C}$ $T_{vj} = 125^{\circ}\text{C}$ $T_{vj} = 150^{\circ}\text{C}$	$V_{CE\text{ sat}}$	1,80 2,10 2,20	2,20 2,60 2,70	V V V
栅极阈值电压 Gate threshold voltage	$I_C = 32,0\text{ mA}, V_{CE} = V_{GE}, T_{vj} = 25^{\circ}\text{C}$		$V_{GEth}$	5,20	5,80	6,40 V
栅极电荷 Gate charge	$V_{GE} = -15 / 15\text{ V}$		$Q_G$	8,30		$\mu\text{C}$
内部栅极电阻 Internal gate resistor	$T_{vj} = 25^{\circ}\text{C}$		$R_{Gint}$	1,9		$\Omega$
输入电容 Input capacitance	$f = 1000\text{ kHz}, T_{vj} = 25^{\circ}\text{C}, V_{CE} = 25\text{ V}, V_{GE} = 0\text{ V}$		$C_{ies}$	65,0		nF
反向传输电容 Reverse transfer capacitance	$f = 1000\text{ kHz}, T_{vj} = 25^{\circ}\text{C}, V_{CE} = 25\text{ V}, V_{GE} = 0\text{ V}$		$C_{res}$	2,10		nF
集电极-发射极截止电流 Collector-emitter cut-off current	$V_{CE} = 1700\text{ V}, V_{GE} = 0\text{ V}, T_{vj} = 25^{\circ}\text{C}$		$I_{CES}$		5,0	mA
栅极-发射极漏电流 Gate-emitter leakage current	$V_{CE} = 0\text{ V}, V_{GE} = 20\text{ V}, T_{vj} = 25^{\circ}\text{C}$		$I_{GES}$		400	nA
开通延迟时间(电感负载) Turn-on delay time, inductive load	$I_C = 800\text{ A}, V_{CE} = 900\text{ V}$ $V_{GE} = -15 / 15\text{ V}$ $R_{Gon} = 0,8\ \Omega$	$T_{vj} = 25^{\circ}\text{C}$ $T_{vj} = 125^{\circ}\text{C}$ $T_{vj} = 150^{\circ}\text{C}$	$t_{don}$	0,59 0,63 0,64		$\mu\text{s}$ $\mu\text{s}$ $\mu\text{s}$
上升时间(电感负载) Rise time, inductive load	$I_C = 800\text{ A}, V_{CE} = 900\text{ V}$ $V_{GE} = -15 / 15\text{ V}$ $R_{Gon} = 0,8\ \Omega$	$T_{vj} = 25^{\circ}\text{C}$ $T_{vj} = 125^{\circ}\text{C}$ $T_{vj} = 150^{\circ}\text{C}$	$t_r$	0,14 0,16 0,16		$\mu\text{s}$ $\mu\text{s}$ $\mu\text{s}$
关断延迟时间(电感负载) Turn-off delay time, inductive load	$I_C = 800\text{ A}, V_{CE} = 900\text{ V}$ $V_{GE} = -15 / 15\text{ V}$ $R_{Goff} = 1,8\ \Omega$	$T_{vj} = 25^{\circ}\text{C}$ $T_{vj} = 125^{\circ}\text{C}$ $T_{vj} = 150^{\circ}\text{C}$	$t_{doff}$	1,00 1,15 1,15		$\mu\text{s}$ $\mu\text{s}$ $\mu\text{s}$
下降时间(电感负载) Fall time, inductive load	$I_C = 800\text{ A}, V_{CE} = 900\text{ V}$ $V_{GE} = -15 / 15\text{ V}$ $R_{Goff} = 1,8\ \Omega$	$T_{vj} = 25^{\circ}\text{C}$ $T_{vj} = 125^{\circ}\text{C}$ $T_{vj} = 150^{\circ}\text{C}$	$t_f$	0,32 0,50 0,55		$\mu\text{s}$ $\mu\text{s}$ $\mu\text{s}$
开通损耗能量(每脉冲) Turn-on energy loss per pulse	$I_C = 800\text{ A}, V_{CE} = 900\text{ V}, L_{\sigma} = 50\text{ nH}$ $V_{GE} = -15 / 15\text{ V}, R_{Gon} = 0,8\ \Omega$	$T_{vj} = 25^{\circ}\text{C}$ $T_{vj} = 125^{\circ}\text{C}$ $T_{vj} = 150^{\circ}\text{C}$	$E_{on}$	145 215 245		mJ mJ mJ
关断损耗能量(每脉冲) Turn-off energy loss per pulse	$I_C = 800\text{ A}, V_{CE} = 900\text{ V}, L_{\sigma} = 50\text{ nH}$ $du/dt = 3300\text{ V}/\mu\text{s} (T_{vj} = 150^{\circ}\text{C})$ $V_{GE} = -15 / 15\text{ V}, R_{Goff} = 1,8\ \Omega$	$T_{vj} = 25^{\circ}\text{C}$ $T_{vj} = 125^{\circ}\text{C}$ $T_{vj} = 150^{\circ}\text{C}$	$E_{off}$	255 330 365		mJ mJ mJ
短路数据 SC data	$V_{GE} \leq 15\text{ V}, V_{CC} = 1000\text{ V}$ $V_{CE\max} = V_{CES} - L_{SCE} \cdot di/dt$ $t_P \leq 10\ \mu\text{s}, T_{vj} = 150^{\circ}\text{C}$		$I_{SC}$	3400		A
结 - 外壳热阻 Thermal resistance, junction to case	每个 IGBT / per IGBT		$R_{thJC}$		25,7	K/kW
外壳 - 散热器热阻 Thermal resistance, case to heatsink	每个 IGBT / per IGBT $\lambda_{\text{Paste}} = 1\text{ W}/(\text{m}\cdot\text{K})$ / $\lambda_{\text{grease}} = 1\text{ W}/(\text{m}\cdot\text{K})$		$R_{thCH}$		22,8	K/kW
在开关状态下温度 Temperature under switching conditions			$T_{vj\text{ op}}$	-40	150	$^{\circ}\text{C}$

## 二极管, 逆变器 / Diode, Inverter

### 最大额定值 / Maximum Rated Values

反向重复峰值电压 Repetitive peak reverse voltage	$T_{vj} = 25^{\circ}\text{C}$	$V_{RRM}$	1700	V
连续正向直流电流 Continuous DC forward current		$I_F$	800	A
正向重复峰值电流 Repetitive peak forward current	$t_P = 1\text{ ms}$	$I_{FRM}$	1600	A
$I^2t$ -值 $I^2t$ - value	$V_R = 0\text{ V}, t_P = 10\text{ ms}, T_{vj} = 125^{\circ}\text{C}$ $V_R = 0\text{ V}, t_P = 10\text{ ms}, T_{vj} = 150^{\circ}\text{C}$	$I^2t$	240 210	$\text{kA}^2\text{s}$ $\text{kA}^2\text{s}$
最大损耗功率 Maximum power dissipation	$T_{vj} = 150^{\circ}\text{C}$	$P_{RQM}$	1200	kW
最小开通时间 Minimum turn-on time		$t_{on\ min}$	10,0	$\mu\text{s}$

### 特征值 / Characteristic Values

			min.	typ.	max.	
正向电压 Forward voltage	$I_F = 800\text{ A}, V_{GE} = 0\text{ V}$ $I_F = 800\text{ A}, V_{GE} = 0\text{ V}$ $I_F = 800\text{ A}, V_{GE} = 0\text{ V}$	$T_{vj} = 25^{\circ}\text{C}$ $T_{vj} = 125^{\circ}\text{C}$ $T_{vj} = 150^{\circ}\text{C}$	$V_F$	1,55 1,60 1,65	2,00 2,05 2,10	V V V
反向恢复峰值电流 Peak reverse recovery current	$I_F = 800\text{ A}, -di_F/dt = 5600\text{ A}/\mu\text{s} (T_{vj}=150^{\circ}\text{C})$ $V_R = 900\text{ V}$ $V_{GE} = -15\text{ V}$	$T_{vj} = 25^{\circ}\text{C}$ $T_{vj} = 125^{\circ}\text{C}$ $T_{vj} = 150^{\circ}\text{C}$	$I_{RM}$	1000 1150 1200		A A A
恢复电荷 Recovered charge	$I_F = 800\text{ A}, -di_F/dt = 5600\text{ A}/\mu\text{s} (T_{vj}=150^{\circ}\text{C})$ $V_R = 900\text{ V}$ $V_{GE} = -15\text{ V}$	$T_{vj} = 25^{\circ}\text{C}$ $T_{vj} = 125^{\circ}\text{C}$ $T_{vj} = 150^{\circ}\text{C}$	$Q_r$	240 410 450		$\mu\text{C}$ $\mu\text{C}$ $\mu\text{C}$
反向恢复损耗 (每脉冲) Reverse recovery energy	$I_F = 800\text{ A}, -di_F/dt = 5600\text{ A}/\mu\text{s} (T_{vj}=150^{\circ}\text{C})$ $V_R = 900\text{ V}$ $V_{GE} = -15\text{ V}$	$T_{vj} = 25^{\circ}\text{C}$ $T_{vj} = 125^{\circ}\text{C}$ $T_{vj} = 150^{\circ}\text{C}$	$E_{rec}$	160 280 325		mJ mJ mJ
结 - 外壳热阻 Thermal resistance, junction to case	每个二极管 / per diode		$R_{thJC}$		36,8	K/kW
外壳 - 散热器热阻 Thermal resistance, case to heatsink	每个二极管 / per diode $\lambda_{\text{Paste}} = 1\text{ W}/(\text{m}\cdot\text{K}) / \lambda_{\text{grease}} = 1\text{ W}/(\text{m}\cdot\text{K})$		$R_{thCH}$	30,0		K/kW
在开关状态下温度 Temperature under switching conditions			$T_{vj\ op}$	-40	150	$^{\circ}\text{C}$

## 模块 / Module

绝缘测试电压 Isolation test voltage	RMS, f = 50 Hz, t = 1 min.	V <sub>ISOL</sub>	4,0		kV
模块基板材料 Material of module baseplate			AISiC		
内部绝缘 Internal isolation	基本绝缘 (class 1, IEC 61140) basic insulation (class 1, IEC 61140)		AIN		
爬电距离 Creepage distance	端子至散热器 / terminal to heatsink 端子至端子 / terminal to terminal		15,0 15,0		mm
电气间隙 Clearance	端子至散热器 / terminal to heatsink 端子至端子 / terminal to terminal		10,0 10,0		mm
相对电痕指数 Comperative tracking index		CTI	> 600		
			min.	typ.	max.
杂散电感, 模块 Stray inductance module		L <sub>sCE</sub>		20	nH
模块引线电阻, 端子-芯片 Module lead resistance, terminals - chip	T <sub>c</sub> = 25°C, 每个开关 / per switch	R <sub>CC+EE'</sub>		0,33	mΩ
储存温度 Storage temperature		T <sub>stg</sub>	-40		125 °C
模块安装的安装扭矩 Mounting torque for modul mounting	螺丝 M6 根据相应的应用手册进行安装 Screw M6 - Mounting according to valid application note	M	4,25		5,75 Nm
端子联接扭矩 Terminal connection torque	螺丝 M4 根据相应的应用手册进行安装 Screw M4 - Mounting according to valid application note 螺丝 M8 根据相应的应用手册进行安装 Screw M8 - Mounting according to valid application note	M	1,8 8,0	- -	2,1 10 Nm
重量 Weight		G		920	g

输出特性 IGBT, 逆变器 (典型)

output characteristic IGBT, Inverter (typical)

$I_C = f(V_{CE})$   
 $V_{GE} = 15\text{ V}$

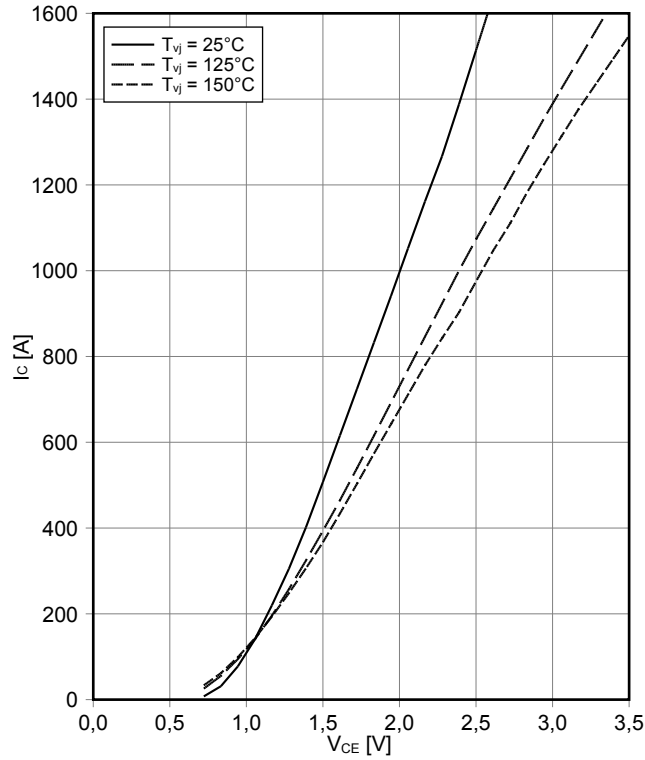

输出特性 IGBT, 逆变器 (典型)

output characteristic IGBT, Inverter (typical)

$I_C = f(V_{CE})$   
 $T_{vj} = 150^\circ\text{C}$

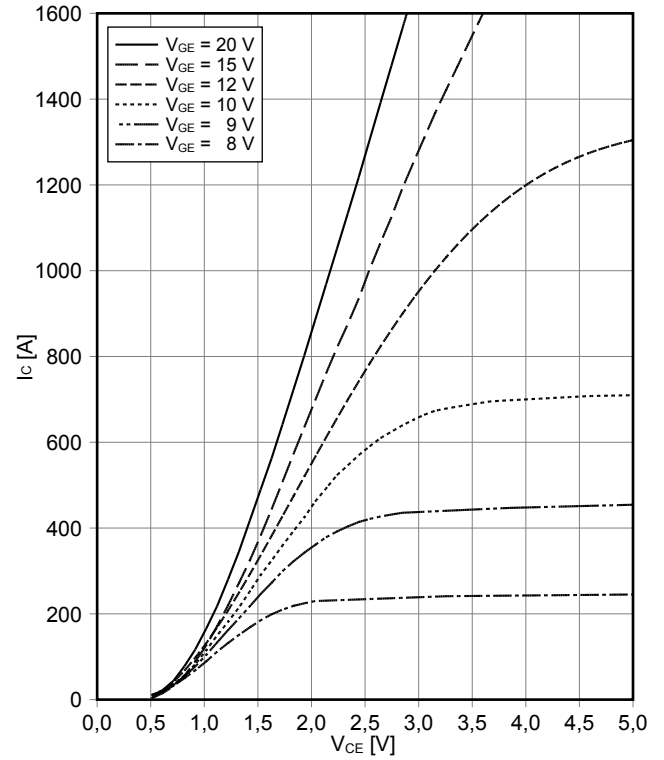

传输特性 IGBT, 逆变器 (典型)

transfer characteristic IGBT, Inverter (typical)

$I_C = f(V_{GE})$   
 $V_{CE} = 20\text{ V}$

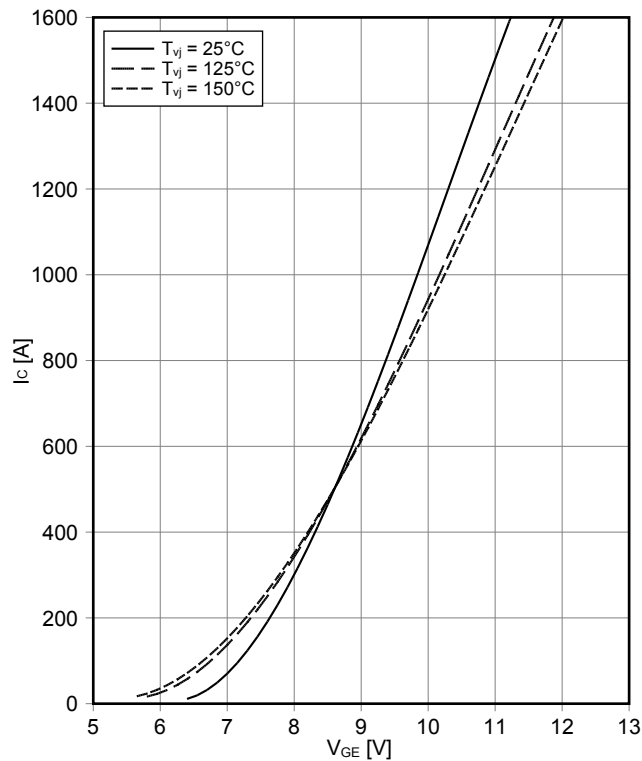

开关损耗 IGBT, 逆变器 (典型)

switching losses IGBT, Inverter (typical)

$E_{on} = f(I_C)$ ,  $E_{off} = f(I_C)$   
 $V_{GE} = \pm 15\text{ V}$ ,  $R_{Gon} = 0.8\ \Omega$ ,  $R_{Goff} = 1.8\ \Omega$ ,  $V_{CE} = 900\text{ V}$

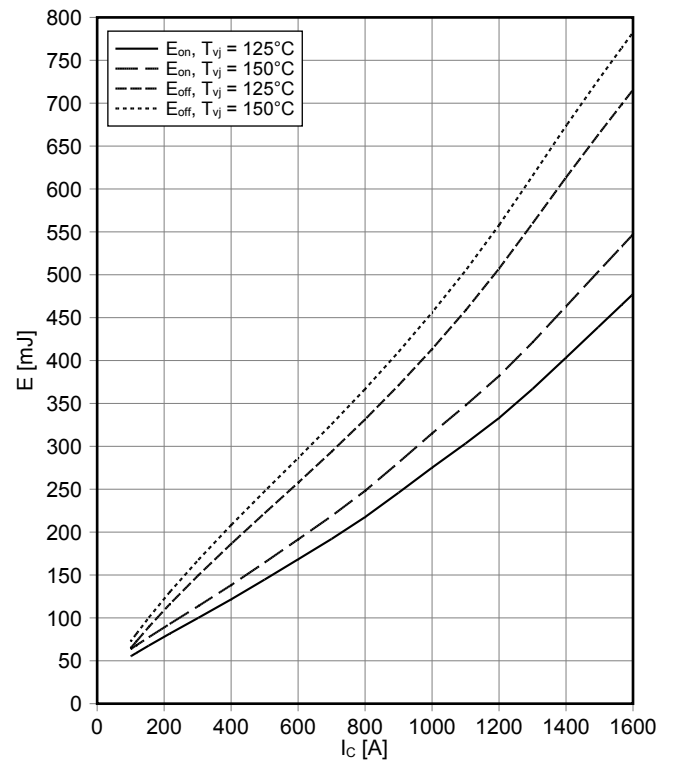

开关损耗 IGBT, 逆变器 (典型)  
**switching losses IGBT, Inverter (typical)**

$E_{on} = f(R_G), E_{off} = f(R_G)$   
 $V_{GE} = \pm 15 \text{ V}, I_C = 800 \text{ A}, V_{CE} = 900 \text{ V}$

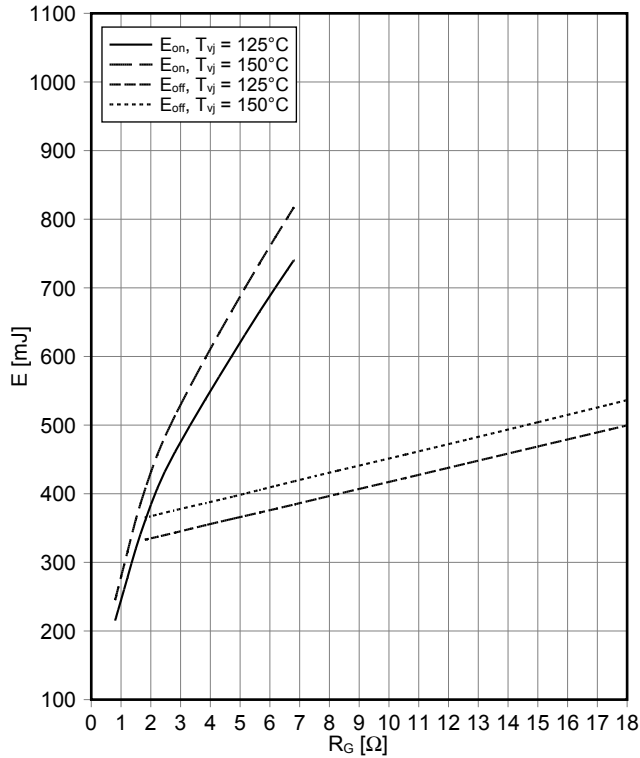

瞬态热阻抗 IGBT, 逆变器  
**transient thermal impedance IGBT, Inverter**  
 $Z_{thJC} = f(t)$

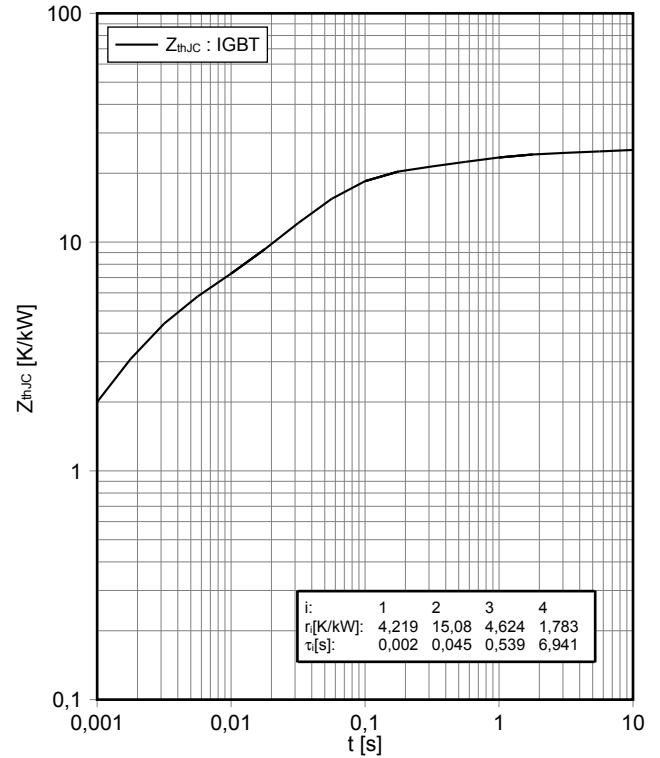

反偏安全工作区 IGBT, 逆变器 (RBSOA)  
**reverse bias safe operating area IGBT, Inverter (RBSOA)**

$I_C = f(V_{CE})$   
 $V_{GE} = \pm 15 \text{ V}, R_{Goff} = 1.8 \Omega, T_{vj} = 150^\circ\text{C}$

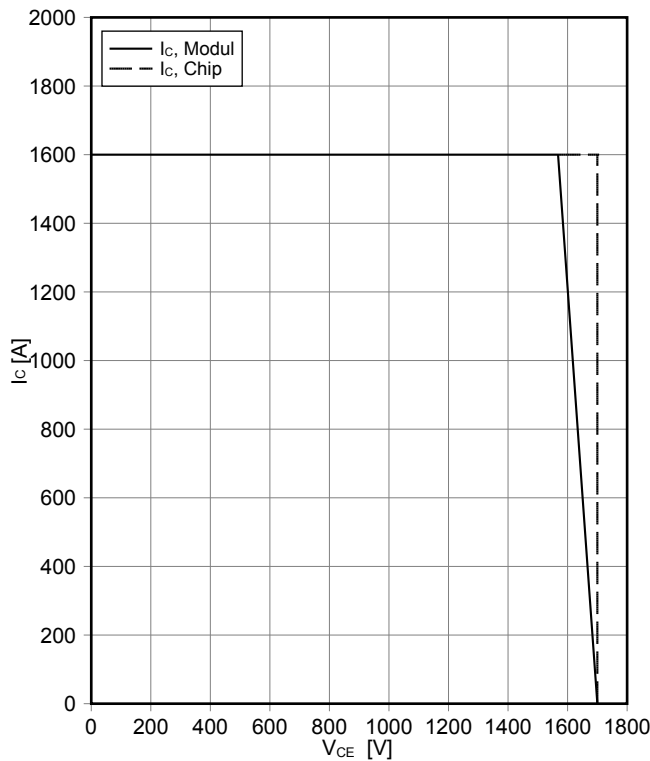

栅极电荷特性 IGBT, 逆变器 (典型)  
**gate charge characteristic IGBT, Inverter (typical)**

$V_{GE} = f(Q_G)$   
 $I_C = 800 \text{ A}, T_{vj} = 25^\circ\text{C}$

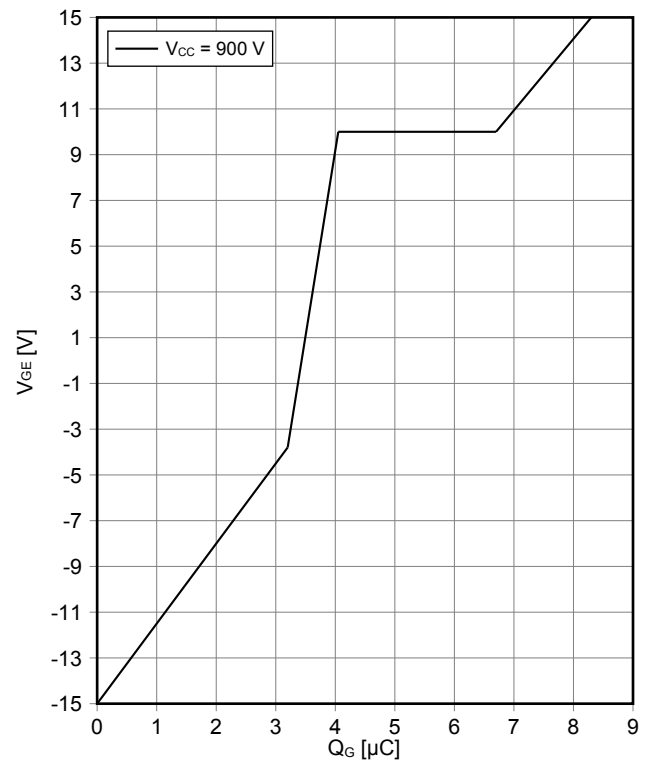

正向偏压特性 二极管,逆变器 (典型)  
**forward characteristic of Diode, Inverter (typical)**  
 $I_F = f(V_F)$

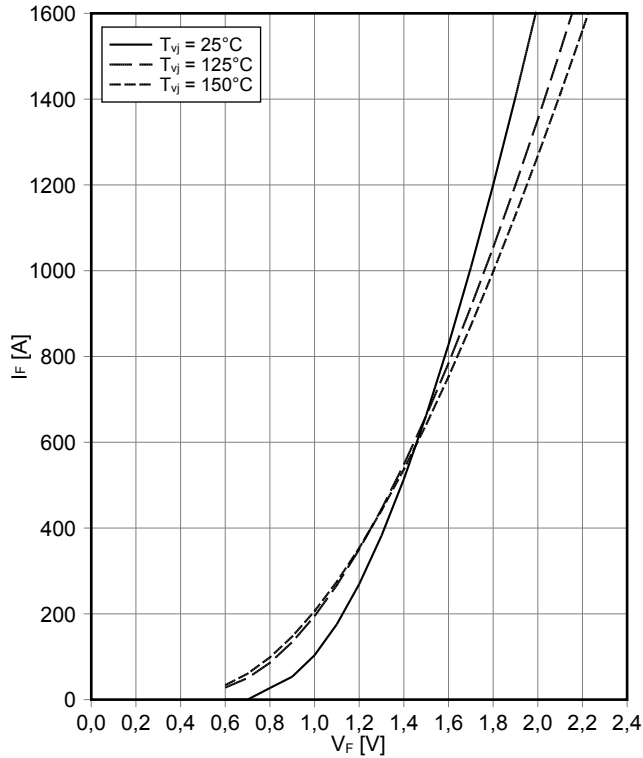

开关损耗 二极管,逆变器 (典型)  
**switching losses Diode, Inverter (typical)**  
 $E_{rec} = f(I_F)$   
 $R_{Gon} = 0.8 \Omega, V_{CE} = 900 \text{ V}$

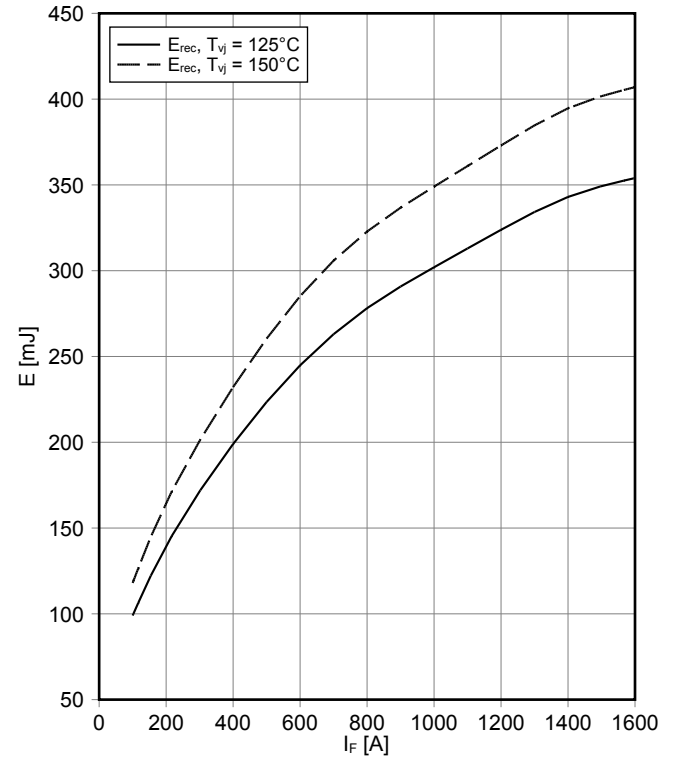

开关损耗 二极管,逆变器 (典型)  
**switching losses Diode, Inverter (typical)**  
 $E_{rec} = f(R_G)$   
 $I_F = 800 \text{ A}, V_{CE} = 900 \text{ V}$

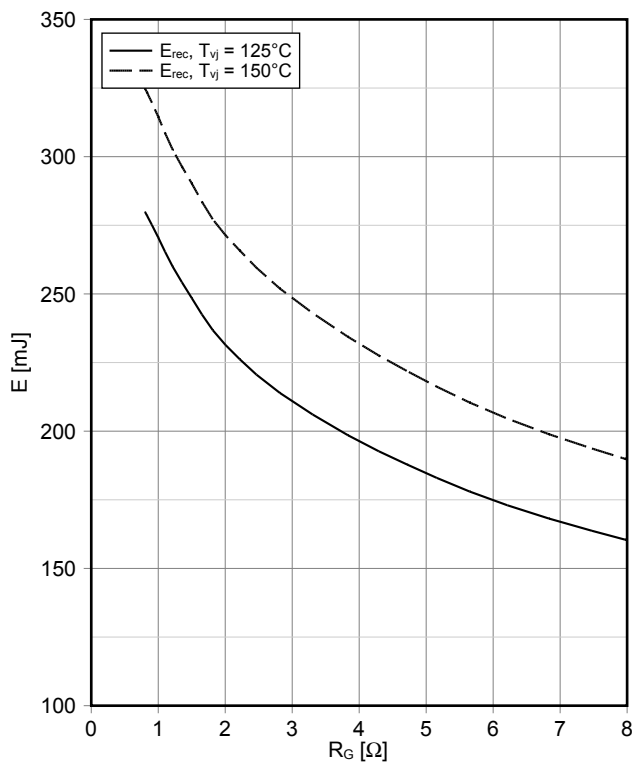

瞬态热阻抗 二极管,逆变器  
**transient thermal impedance Diode, Inverter**  
 $Z_{thJC} = f(t)$

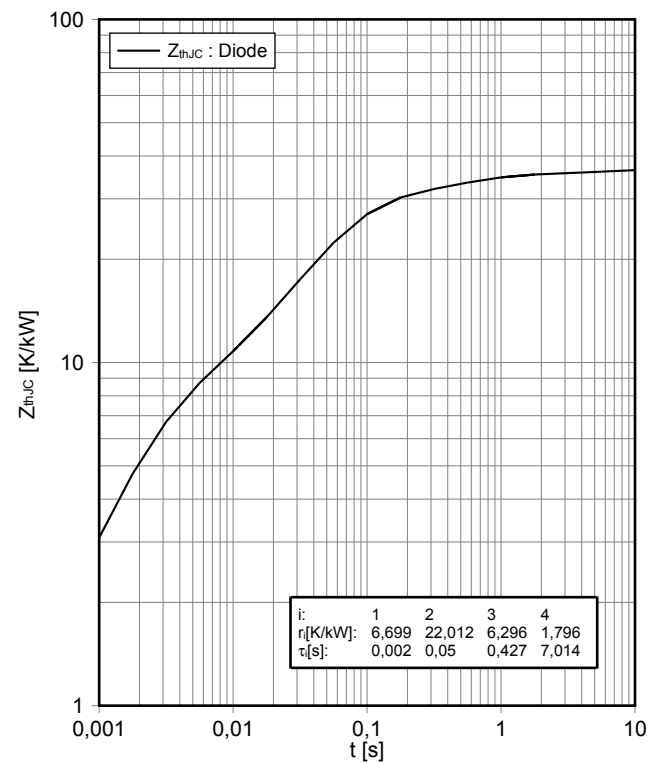

安全工作区 二极管, 逆变器 (SOA)

safe operation area Diode, Inverter (SOA)

$$I_R = f(V_R)$$

$T_{vj} = 150^\circ\text{C}$

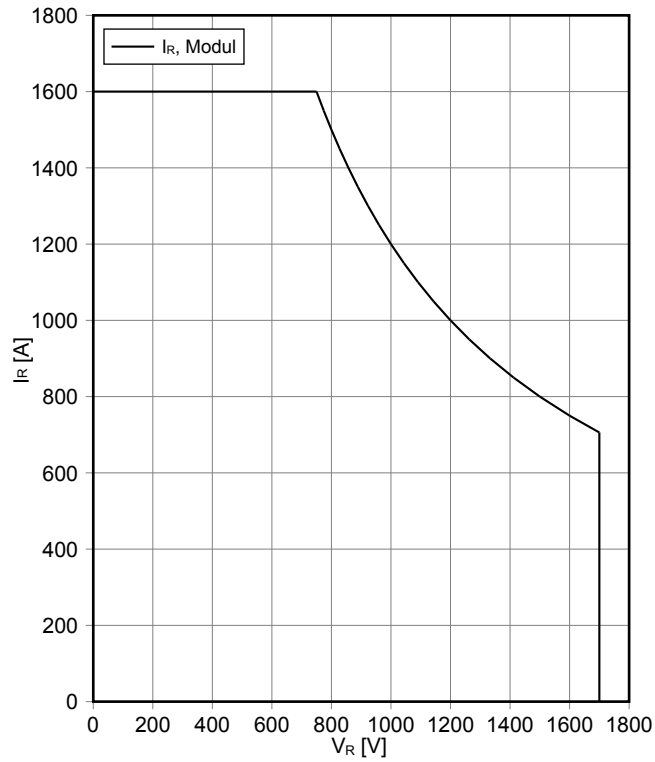



## 接线图 / Circuit diagram

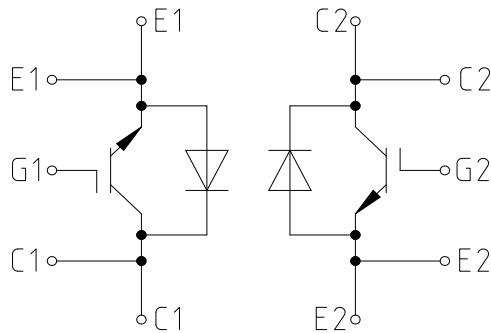

## 封装尺寸 / Package outlines

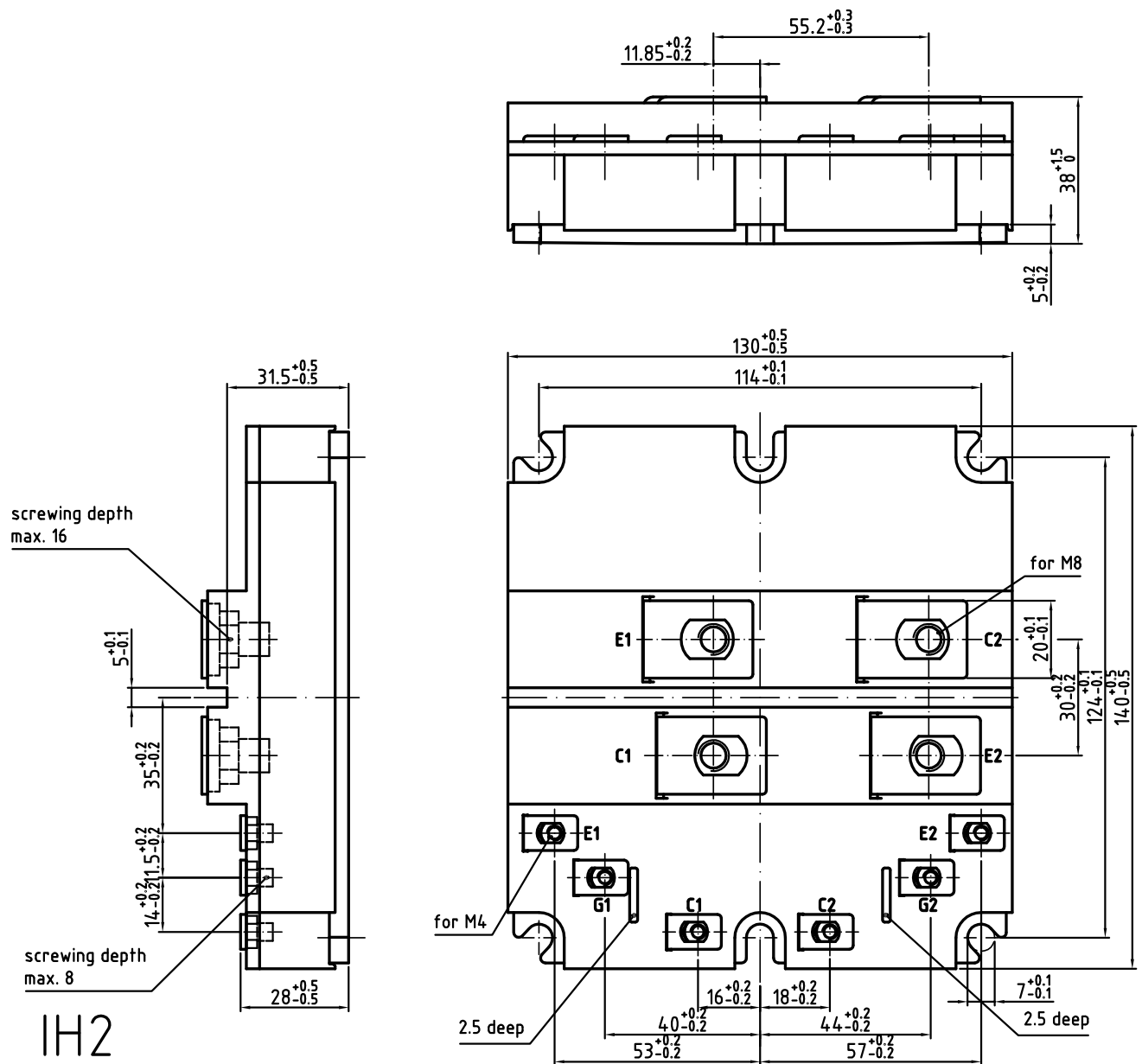

#### Trademarks

All referenced product or service names and trademarks are the property of their respective owners.

Edition 2018-12-05

Published by  
Infineon Technologies AG  
81726 München, Germany

© 2018 Infineon Technologies AG.  
All Rights Reserved.

Do you have a question about this document?  
Email: [erratum@infineon.com](mailto:erratum@infineon.com)

#### 重要提示

本文档所提供的任何信息绝不当被视为针对任何条件或者品质而做出的保证（质量保证）。英飞凌对于本文档中所提及的任何事例、提示或者任何特定数值及/或任何关于产品应用方面的信息均在此明确声明其不承担任何保证或者责任，包括但不限于其不侵犯任何第三方知识产权的保证均在此排除。

此外，本文档所提供的任何信息均取决于客户履行本文档所载明的义务和客户遵守适用于客户产品以及与客户对于英飞凌产品的应用所相关的任何法律要求、规范和标准。

本文档所含的数据仅供经过专业技术培训的人员使用。客户自身的技术部门有义务对于产品是否适宜于其预期的应用和针对该等应用而言本文档中所提供的信息是否充分自行予以评估。

如需产品、技术、交付条款和条件以及价格等进一步信息，请向离您最近的英飞凌科技办公室接洽（[www.infineon.com](http://www.infineon.com)）。

#### 警告事项

由于技术所需产品可能含有危险物质。如需了解该等物质的类型，请向离您最近的英飞凌科技办公室接洽。

除非由经英飞凌科技授权代表签署的书面文件中做出另行明确批准的情况外，英飞凌科技的产品不当被用于任何一项一旦产品失效或者产品使用的后果可被合理地预料到可能导致人身伤害的任何应用领域。

#### IMPORTANT NOTICE

The information given in this document shall in no event be regarded as a guarantee of conditions or characteristics ("Beschaffenheitsgarantie"). With respect to any examples, hints or any typical values stated herein and/or any information regarding the application of the product, Infineon Technologies hereby disclaims any and all warranties and liabilities of any kind, including without limitation warranties of non-infringement of intellectual property rights of any third party.

In addition, any information given in this document is subject to customer's compliance with its obligations stated in this document and any applicable legal requirements, norms and standards concerning customer's products and any use of the product of Infineon Technologies in customer's applications.

The data contained in this document is exclusively intended for technically trained staff. It is the responsibility of customer's technical departments to evaluate the suitability of the product for the intended application and the completeness of the product information given in this document with respect to such application.

For further information on the product, technology, delivery terms and conditions and prices please contact your nearest Infineon Technologies office ([www.infineon.com](http://www.infineon.com)).

#### WARNINGS

Due to technical requirements products may contain dangerous substances. For information on the types in question please contact your nearest Infineon Technologies office.

Except as otherwise explicitly approved by Infineon Technologies in a written document signed by authorized representatives of Infineon Technologies, Infineon Technologies' products may not be used in any applications where a failure of the product or any consequences of the use thereof can reasonably be expected to result in personal injury.

# Mouser Electronics

Authorized Distributor

Click to View Pricing, Inventory, Delivery & Lifecycle Information:

[Infineon:](#)

[FF800R17KP4\\_B2](#)