

注記 NOTES

- △ 偶数極品に適用。
APPLIES ONLY TO EVEN NO. CKT. SIZES.
 - 2. 嵌合相手：51102,51103 シリーズ
MATES WITH : 51102,51103 SERIES.
 - △ 2極はキンクを付加しない。
3極以上のキンク形状は両サイドが ②、その他の極はすべて ① 形状とする。
- KINK FORM
2 CIRCUIT:PINS TO BE NOT KINKED.
MORE THAN 2 CURCUIT:
PINS AT BOTH ENDS ARE KINK FORMED TO ②,
THE OTHER PINS ARE KINK FORMED TO ①.
- 4. 製品番号の下1桁は色を表します。
LAST DIGIT OF PART NUMBER INDICATES COLOR.
0:白 WHITE 2:赤 RED

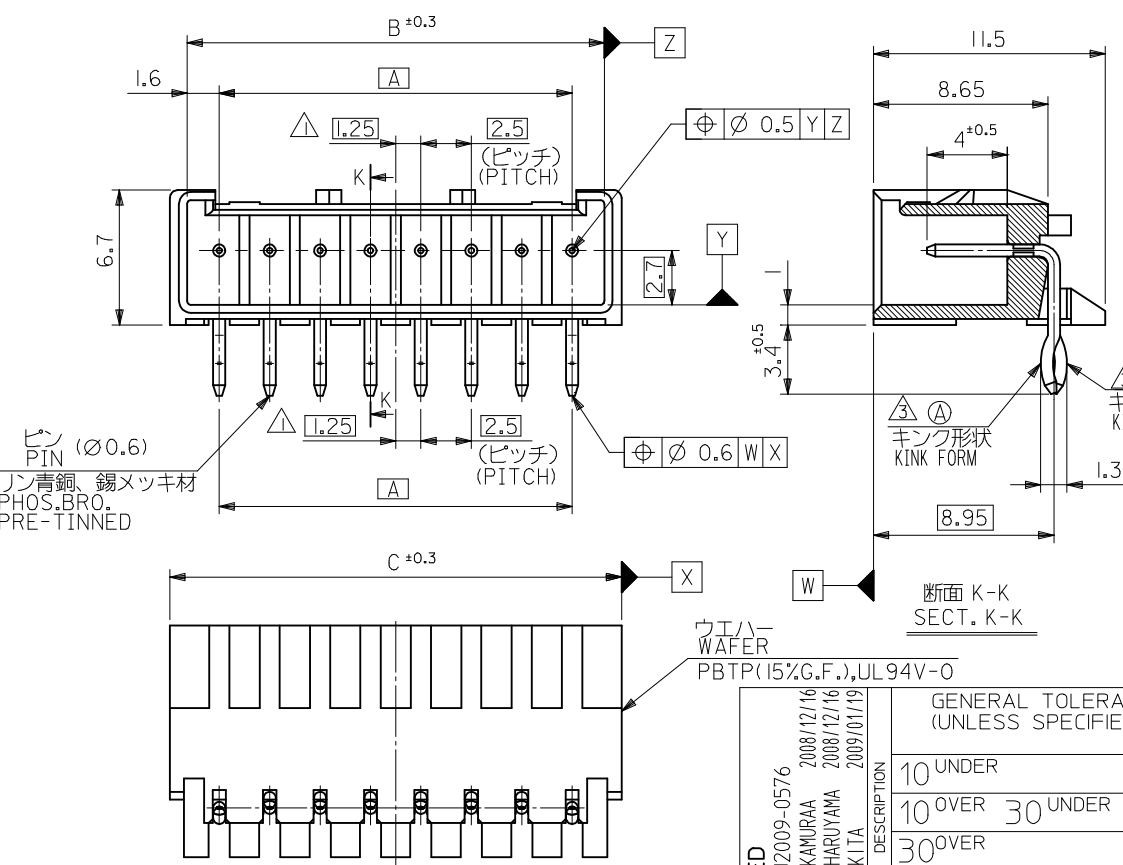
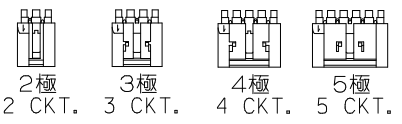
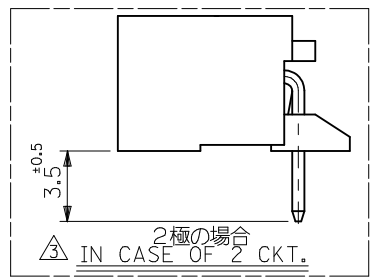

1.9	1.25	39.9	38.2	35		53426-1510	15
		37.4	35.7	32.5		53426-1410	14
		34.9	33.2	30		53426-1310	13
		32.4	30.7	27.5		53426-1210	12
		29.9	28.2	25		53426-1110	11
		27.4	25.7	22.5		53426-1010	10
		24.9	23.2	20		53426-0910	9
		22.4	20.7	17.5		53426-0810	8
		19.9	18.2	15		53426-0710	7
		17.4	15.7	12.5		53426-0610	6
		14.9	13.2	10		53426-0510	5
	1.25	12.4	10.7	7.5	53426-0412	53426-0410	4
1.9	1	9.9	8.2	5		53426-0310	3
#	#	7.4	5.7	2.5		53426-0210	2
E	D	C	B	A	53426-***12 COLOR:RED	53426-***10 COLOR:WHITE	極数 NO. OF CKTS.

ウエハー WAFER PBTP(15%G.F.),UL94V-0

GENERAL TOLERANCES (UNLESS SPECIFIED)

10 UNDER	±0.2
10 OVER 30 UNDER	±0.25
30 OVER	±0.3
ANGULAR	±3 °

DRAFT WHERE APPLICABLE MUST REMAIN WITHIN DIMENSIONS

DIMENSION STYLE MM ONLY

SCALE 4:1

DESIGN UNITS METRIC

THIRD ANGLE PROJECTION

TITLE 2.5 W/B CONN.WAFER ASSY RIGHT ANGLE WITH KINK -LEAD FREE-

MOLEX MOLEX INCORPORATED

DOCUMENT NO. SD-53426-001

SHEET NO. 1 OF 1

MODEL NO. 53426-***1*

THIS DRAWING CONTAINS INFORMATION THAT IS PROPRIETARY TO MOLEX INCORPORATED AND SHOULD NOT BE USED WITHOUT WRITTEN PERMISSION

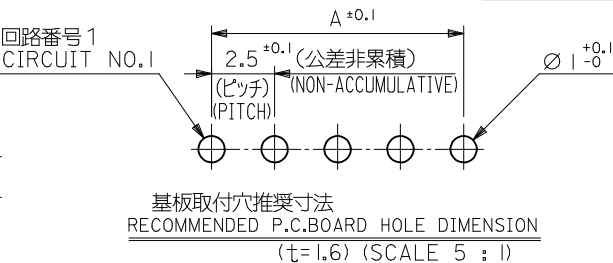
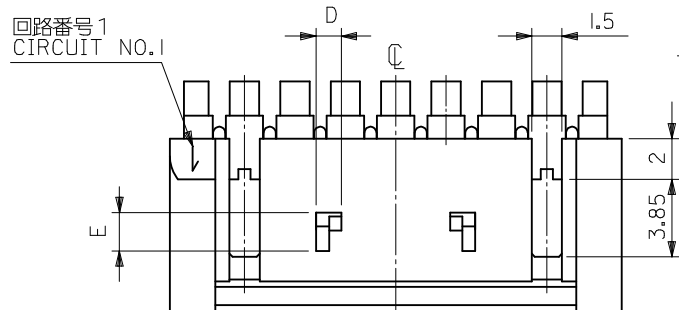

注記 NOTES

- △ 偶数極品に適用。
APPLIES ONLY TO EVEN NO. CKT. SIZES.
- 2. 嵌合相手：51102,51103シリーズ
MATES WITH：51102,51103 SERIES.
- △ 2極はキンクを付加しない。
3極以上のキンク形状は両サイドが(B)、その他の極はすべて(A)形状とする。
KINK FORM
2 CIRCUIT:PINS TO BE NOT KINKED.
MORE THAN 2 CURCUIT:
PINS AT BOTH ENDS ARE KINK FORMED TO (B),
THE OTHER PINS ARE KINK FORMED TO (A).
- 4. 製品番号の下1桁は色を表します。
LAST DIGIT OF PART NUMBER INDICATES COLOR.
0:白 WHITE 2:赤 RED

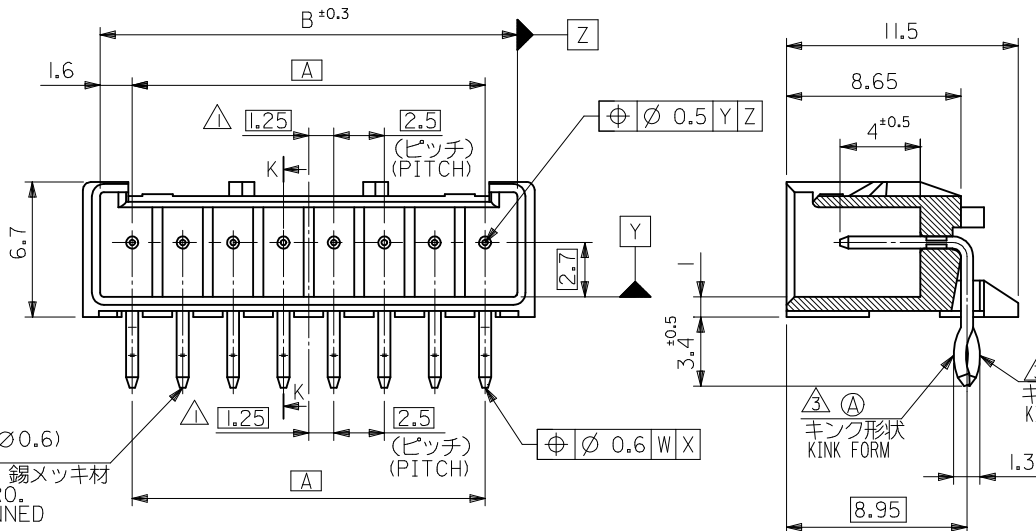
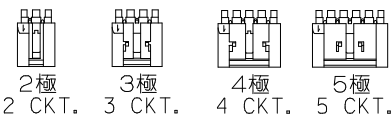
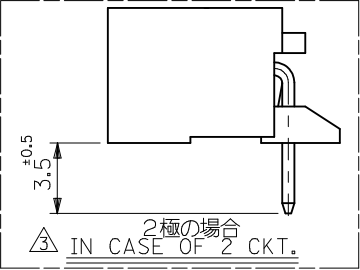

断面 K-K
SECT. K-K

1.9	1.25	39.9	38.2	35		53426-1510	15
		37.4	35.7	32.5		53426-1410	14
		34.9	33.2	30		53426-1310	13
		32.4	30.7	27.5		53426-1210	12
		29.9	28.2	25		53426-1110	11
		27.4	25.7	22.5		53426-1010	10
		24.9	23.2	20		53426-0910	9
		22.4	20.7	17.5		53426-0810	8
		19.9	18.2	15		53426-0710	7
		17.4	15.7	12.5		53426-0610	6
		14.9	13.2	10		53426-0510	5
	1.25	12.4	10.7	7.5	53426-0412	53426-0410	4
1.9	1	9.9	8.2	5		53426-0310	3
#	#	7.4	5.7	2.5		53426-0210	2
E	D	C	B	A	53426-***12 COLOR:RED	53426-***10 COLOR:WHITE	極数 NO. OF CKTS.

REVISED EC NO: J2009-0576 DRWN:NAKAMURAA 2008/12/16 CHKD:T. HARUYAMA 2008/12/16 APPR:NUKITA 2009/01/19	GENERAL TOLERANCES (UNLESS SPECIFIED)		DIMENSION STYLE MM ONLY		SCALE 4:1		DESIGN UNITS METRIC		THIRD ANGLE PROJECTION	
	10 UNDER	±0.2	DRAWN BY	DATE	TITLE					
	10 OVER 30 UNDER	±0.25	K. TOJO	1993/07/23	2.5 W/B CONN.WAFER ASSY RIGHT ANGLE WITH KINK -LEAD FREE-					
	30 OVER	±0.3	CHECKED BY	DATE	MOLEX INCORPORATED					
ANGULAR ±3 °		APPROVED BY T. YAMAGUCHI 2001/11/13		MATERIAL NO. SEE CHART		DOCUMENT NO. SD-53426-001		SHEET NO. 1 OF 1		
DRAFT WHERE APPLICABLE MUST REMAIN WITHIN DIMENSIONS		THIS DRAWING CONTAINS INFORMATION THAT IS PROPRIETARY TO MOLEX INCORPORATED AND SHOULD NOT BE USED WITHOUT WRITTEN PERMISSION								