

DATA SHEET

GENERAL PURPOSE CHIP RESISTORS

RC_L series

$\pm 0.1\%$, $\pm 0.5\%$, $\pm 1\%$, $\pm 5\%$

Sizes 0075/0100/0201/0402/0603/0805/
1206/1210/1218/2010/2512

RoHS compliant & Halogen free



SCOPE

This specification describes RC series chip resistors with lead free terminations made by thick film process.

APPLICATIONS

- All general purpose application

FEATURES

- Halogen Free Epoxy
- RoHS compliant
 - Products with lead free terminations meet RoHS requirements
 - Pb-glass contained in electrodes, resistors element and glass are exempted by RoHS
- Reducing environmentally hazardous wastes
- High component and equipment reliability
- Saving of PCB space
- None forbidden-materials used in products/production

ORDERING INFORMATION - GLOBAL PART NUMBER

Global part numbers are identified by the series, size, tolerance, packing type, temperature coefficient, taping reel and resistance value.

GLOBAL PART NUMBER

RC XXXX X X X XX XXXX L
 (1) (2) (3) (4) (5) (6) (7)

(1) SIZE

0075/0100/0201/0402/0603/0805/1206/1210/1218/2010/2512

(2) TOLERANCE

B = ±0.1%
 D = ±0.5%
 F = ±1.0%
 J = ±5.0% (for jumper ordering, use code of J)

(3) PACKAGING TYPE

R = Paper taping reel
 K = Embossed taping reel
 S = ESD safe reel (0075/0100 only)

(4) TEMPERATURE COEFFICIENT OF RESISTANCE

- = Based on spec.

(5) TAPING REEL

07= 7 inch dia. Reel
 13=13 inch dia. Reel
 7W = 7 inch dia. Reel & 2 x standard power
 7N = 7 inch dia. Reel, ESD safe reel (0075/0100 only)

(6) RESISTANCE VALUE

There are 2~4 digits indicated the resistance value.
 Letter R/K/M is decimal point
 Example:
 97R6 = 97.6Ω
 9K76 = 9760Ω
 1M = 1,000,000Ω

(7) DEFAULT CODE

Letter L is the system default code for ordering only.^(Note)

ORDERING EXAMPLE

The ordering code for a RC0402 0.0625W chip resistor value 100KΩ with ±5% tolerance, supplied in 7-inch tape reel of 10,000 units per reel is: RC0402JR-07100KL.

NOTE

1. All our RSMD products meet RoHS compliant and Halogen Free. "LFP" of the internal 2D reel label mentions "Lead Free Process".
2. On customized label, "LFP" or specific symbol can be printed.

MARKING

RC0075 / RC0100 / RC0201 / RC0402



No Marking

RC0603

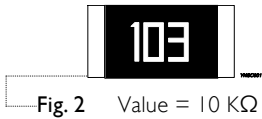

E24 series: 3 digits
First two digits for significant figure and 3rd digit for number of zeros

RC0805 / RC1206 / RC1210 / RC2010 / RC2512

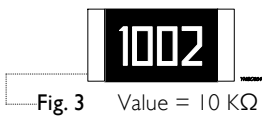

E24/E96 series: 4 digits
First three digits for significant figure and 4th digit for number of zeros

RC1218

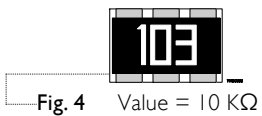

E-24 series: 3 digits, ±5%
First two digits for significant figure and 3rd digit for number of zeros

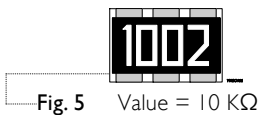

Both E-24 and E-96 series: 4 digits, ±1% & ±0.5%
First three digits for significant figure and 4th digit for number of zeros

For further marking information, please see special data sheet "Chip resistors marking".

CONSTRUCTION

The resistor is constructed on top of a high-grade ceramic body. Internal metal electrodes are added on each end to make the contacts to the thick film resistive element. The composition of the resistive element is a noble metal imbedded into a glass and covered by a second glass to prevent environmental influences. The resistor is laser trimmed to the rated resistance value. The resistor is covered with a protective epoxy coat, finally the two external terminations (matte tin on Nibarrier) are added, as shown in Fig.4.

Outlines

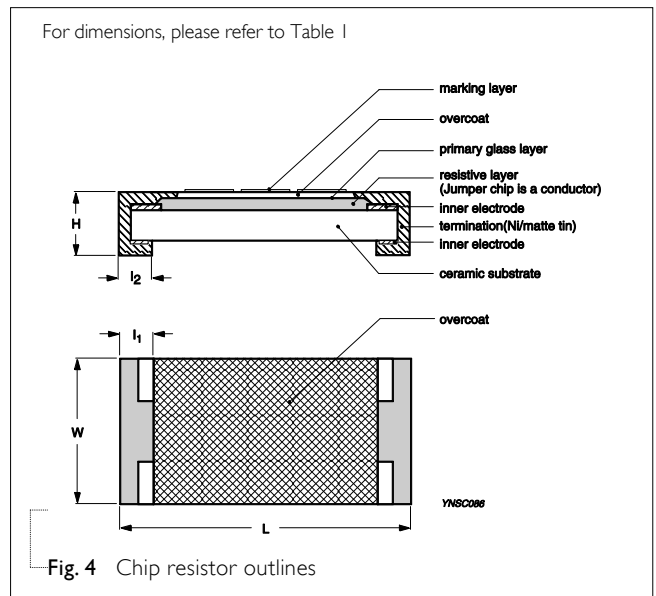

DIMENSION

Table 1

TYPE	L (mm)	W (mm)	H (mm)	l ₁ (mm)	l ₂ (mm)
RC0075	0.30±0.01	0.15±0.01	0.10±0.01	0.08±0.03	0.08±0.03
RC0100	0.40±0.02	0.20±0.02	0.13±0.02	0.10±0.03	0.10±0.03
RC0201	0.60±0.03	0.30±0.03	0.23±0.03	0.10±0.05	0.15±0.05
RC0402	1.00±0.05	0.50±0.05	0.35±0.05	0.20±0.10	0.25±0.10
RC0603	1.60±0.10	0.80±0.10	0.45±0.10	0.25±0.15	0.25±0.15
RC0805	2.00±0.10	1.25±0.10	0.50±0.10	0.35±0.20	0.35±0.20
RC1206	3.10±0.10	1.60±0.10	0.55±0.10	0.45±0.20	0.40±0.20
RC1210	3.10±0.10	2.60±0.15	0.50±0.10	0.45±0.15	0.50±0.20
RC1218	3.10±0.10	4.60±0.10	0.55±0.10	0.45±0.20	0.40±0.20
RC2010	5.00±0.10	2.50±0.15	0.55±0.10	0.45±0.15	0.50±0.20
RC2512(1W)	6.35±0.10	3.10±0.15	0.55±0.10	0.60±0.20	0.50±0.20
RC2512(2W)	6.35±0.10	3.10±0.15	0.55±0.10	0.60±0.20	1.15±0.20

ELECTRICAL CHARACTERISTICS

Table 2

CHARACTERISTICS	POWER	OPERATING TEMPERATURE RANGE	MAXIMUM WORKING VOLTAGE	MAXIMUM OVERLOAD VOLTAGE	DIELECTRIC WITHSTANDING VOLTAGE	RESISTANCE RANGE	TEMPERATURE COEFFICIENT	JUMPER CRITERIA
RC0075	1/50 W	-55°C to 125°C	10V	25V	25V	5% (E24) 10Ω ≤ R ≤ 1MΩ 1% (E24/E96) 10Ω ≤ R ≤ 1MΩ Jumper < 50mΩ	10Ω ≤ R < 100Ω: -200~+600ppm/°C 100Ω ≤ R ≤ 1MΩ: ±200ppm/°C	Rated Current 0.5A Maximum Current 1.0A
RC0100	1/32 W	-55°C to 125°C	15V	30V	30V	5% (E24) 1Ω ≤ R ≤ 22MΩ 1% (E24/E96) 1Ω ≤ R ≤ 10MΩ 0.5% (E24/E96) 33Ω ≤ R ≤ 470KΩ Jumper < 50mΩ	1Ω ≤ R < 100Ω: -200~+600ppm/°C 100Ω ≤ R ≤ 10MΩ: ±300ppm/°C 100Ω ≤ R ≤ 10MΩ: ±200ppm/°C 10MΩ < R ≤ 22MΩ: ±250ppm/°C	Rated Current 0.5A Maximum Current 1.0A
RC0201	1/20 W	-55°C to 125°C	25V	50V	50V	5% (E24) 1Ω ≤ R ≤ 10MΩ 1% (E24/E96) 1Ω ≤ R ≤ 10MΩ 0.1%, 0.5% (E24/E96) 10Ω ≤ R ≤ 1MΩ Jumper < 50mΩ	1Ω ≤ R ≤ 10Ω: -100~+350ppm/°C 10Ω < R ≤ 10MΩ: ±200ppm/°C	Rated Current 0.5A Maximum Current 1.0A

Table 2

CHARACTERISTICS	POWER	OPERATING TEMPERATURE RANGE	MAXIMUM WORKING VOLTAGE	MAXIMUM OVERLOAD VOLTAGE	DIELECTRIC WITHSTANDING VOLTAGE	RESISTANCE RANGE	TEMPERATURE COEFFICIENT	JUMPER CRITERIA
RC0402	1/16 W	-55°C to 155°C	50V	100V	100V	5% (E24) 1Ω≤R≤22MΩ 1% (E24/E96) 1Ω≤R≤10MΩ 0.1%, 0.5% (E24/E96) 10Ω≤R≤1MΩ Jumper<50mΩ	1Ω≤R≤10Ω ±200ppm°C 10Ω<R≤10MΩ ±100ppm°C 10MΩ<R≤22MΩ ±200ppm°C	Rated Current 1.0A Maximum Current 2.0A
	1/8W	-55°C to 155°C	50V	100V	100V	5% (E24) 1Ω≤R≤1MΩ 1% (E24/E96) 1Ω≤R≤1MΩ	1Ω≤R≤1MΩ ±200ppm°C	
RC0603	1/10 W	-55°C to 155°C	75V	150V	150V	5% (E24) 1Ω≤R≤22MΩ 1% (E24/E96) 1Ω≤R≤10MΩ 0.1%, 0.5% (E24/E96) 10Ω≤R≤1MΩ Jumper<50mΩ	1Ω≤R≤10Ω ±200ppm°C 10Ω<R≤10MΩ ±100ppm°C 10MΩ<R≤22MΩ ±200ppm°C	Rated Current 1.0A Maximum Current 2.0A
	1/5 W	-55°C to 155°C	75V	150V	150V	5% (E24) 1Ω≤R≤1MΩ 1% (E24/E96) 1Ω≤R≤1MΩ	1Ω≤R≤1MΩ ±200ppm°C	
RC0805	1/8 W	-55°C to 155°C	150V	300V	300V	5% (E24) 1Ω≤R≤22MΩ 1% (E24/E96) 1Ω≤R≤10MΩ 0.1%, 0.5% (E24/E96) 10Ω≤R≤1MΩ 5%, 10%, 20% (E24) 24MΩ≤R≤100MΩ Jumper<50mΩ	1Ω≤R≤10Ω ±200ppm°C 10Ω<R≤10MΩ ±100ppm°C 10MΩ<R≤22MΩ ±200ppm°C 24MΩ<R≤100MΩ ±300ppm°C	Rated Current 2.0A Maximum Current 5.0A
	1/4 W	-55°C to 155°C	150V	300V	300V	5% (E24) 1Ω≤R≤1MΩ 1% (E24/E96) 1Ω≤R≤1MΩ	1Ω≤R≤1MΩ ±200ppm°C	
RC1206	1/4 W	-55°C to 155°C	200V	400V	500V	5% (E24) 1Ω≤R≤22MΩ 1% (E24/E96) 1Ω≤R≤10MΩ 0.1%, 0.5% (E24/E96) 10Ω≤R≤1MΩ 5%, 10%, 20% (E24) 24MΩ≤R≤100MΩ Jumper<50mΩ	1Ω≤R≤10Ω ±200ppm°C 10Ω<R≤10MΩ ±100ppm°C 10MΩ<R≤22MΩ ±200ppm°C 24MΩ≤R≤100MΩ ±300ppm°C	Rated Current 2.0A Maximum Current 10.0A
	1/2 W	-55°C to 155°C	200V	400V	500V	5% (E24) 1Ω≤R≤1MΩ 1% (E24/E96) 1Ω≤R≤1MΩ	1Ω≤R≤1MΩ ±200ppm°C	

FOOTPRINT AND SOLDERING PROFILES

For recommended footprint and soldering profiles, please refer to data sheet “Chip resistors mounting”

Table 2

CHARACTERISTICS	POWER	OPERATING TEMPERATURE RANGE	MAXIMUM WORKING VOLTAGE	MAXIMUM OVERLOAD VOLTAGE	DIELECTRIC WITHSTANDING VOLTAGE	RESISTANCE RANGE	TEMPERATURE COEFFICIENT	JUMPER CRITERIA
RC1210	1/2 W	-55°C to 155°C	200V	500V	500V	5% (E24) 1Ω≤R≤22MΩ	1Ω≤R≤10Ω ±200ppm°C	Rated Current 2.0A
						1% (E24/E96) 1Ω≤R≤10MΩ	10Ω<R≤10MΩ ±100ppm°C	Maximum Current 10.0A
RC1218	1 W	-55°C to 155°C	200V	500V	500V	0.1%, 0.5% (E24/E96) 10Ω≤R≤1MΩ	10MΩ<R≤22MΩ ±200ppm°C	
						Jumper<50mΩ		
RC2010	3/4 W	-55°C to 155°C	200V	500V	500V	5% (E24) 1Ω≤R≤22MΩ	1Ω≤R≤10Ω ±200ppm°C	Rated Current 2.0A
						1% (E24/E96) 1Ω≤R≤10MΩ	10Ω<R≤10MΩ ±100ppm°C	Maximum Current 10.0A
RC2512	1 W	-55°C to 155°C	200V	500V	500V	0.1%, 0.5% (E24/E96) 10Ω≤R≤1MΩ	10MΩ<R≤22MΩ ±200ppm°C	
						Jumper<50mΩ		
	2 W	-55°C to 155°C	200V	400V	500V	5% (E24) 1Ω≤R≤1MΩ	1Ω≤R≤1MΩ ±200ppm°C	
						1% (E24/E96) 1Ω≤R≤1MΩ		

PACKING STYLE AND PACKAGING QUANTITY

Table 3 Packing style and packaging quantity

PACKING STYLE	PAPER TAPING REEL (R)		ESD SAFE REEL (S) (4MM WIDTH, 1MM PITCH PLASTIC EMBOSSED)	EMBOSSSED TAPING REEL
REEL DIMENSION	7" (178 mm)	13" (330 mm)	7" (178 mm)	7" (178 mm)
RC0075	---	---	20,000	---
RC0100	20,000	80,000	40,000	---
RC0201	10,000	50000	---	---
RC0402	10,000	50000	---	---
RC0603	5,000	20000	---	---
RC0805	5,000	20000	---	---
RC1206	5,000	20000	---	---
RC1210	5,000	20000	---	---
RC1218	---	---	---	4,000
RC2010	---	---	---	4,000
RC2512	---	---	---	4,000

NOTE

For tape and reel specification/dimensions, please refer to data sheet "Chip resistors packing".

FUNCTIONAL DESCRIPTION

OPERATING TEMPERATURE RANGE

RC0402 to RC2512 Range: -55°C to +155°C (Fig. 5-1)

RC0075 to RC0201 Range: -55°C to +125°C (Fig. 5-2)

POWER RATING

Each type rated power at 70 °C:

- RC0075=1/50W
- RC0100=1/32W
- RC0201=1/20W
- RC0402=1/16W, 1/8W
- RC0603=1/10W, 1/5W
- RC0805=1/8W, 1/4W
- RC1206=1/4W, 1/2W
- RC1210=1/2W
- RC1218=1W
- RC2010=3/4W
- RC2512=1W, 2W

RATED VOLTAGE

The DC or AC (rms) continuous working voltage corresponding to the rated power is determined by the following formula:

$$V = \sqrt{(P \times R)}$$

Where

V = Continuous rated DC or AC (rms) working voltage (V)

P = Rated power (W)

R = Resistance value (Ω)

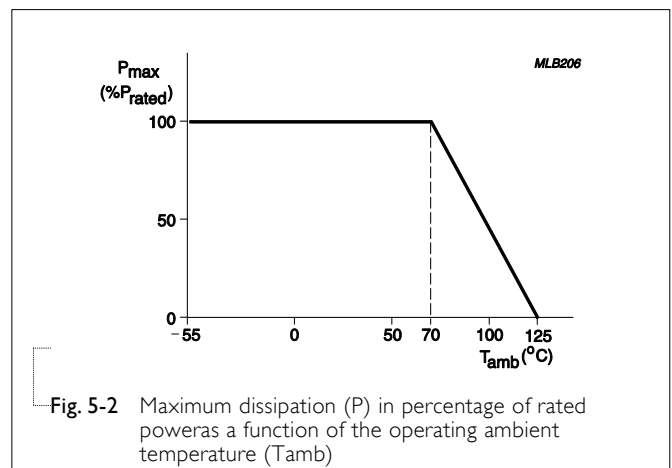
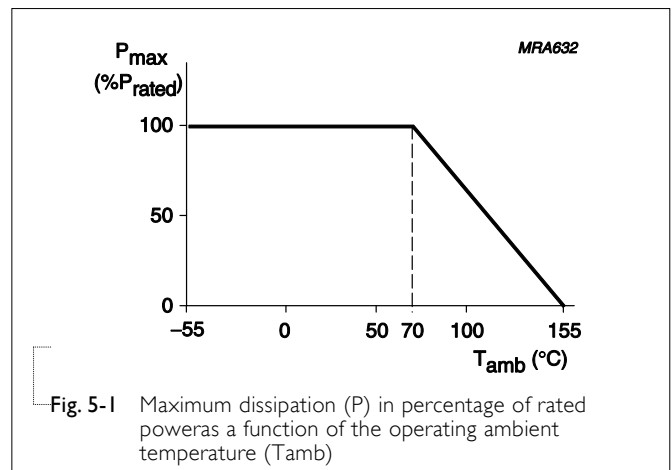

TESTS AND REQUIREMENTS

Table 8 Test condition, procedure and requirements

TEST	TEST METHOD	PROCEDURE	REQUIREMENTS
Temperature Coefficient of Resistance (T.C.R.)	MIL-STD-202 Method 304	At +25/-55 °C and +25/+125 °C Formula: $T.C.R = \frac{R_2 - R_1}{R_1(t_2 - t_1)} \times 10^6 \text{ (ppm/°C)}$ Where t ₁ =+25 °C or specified room temperature t ₂ =-55 °C or +125 °C test temperature R ₁ =resistance at reference temperature in ohms R ₂ =resistance at test temperature in ohms	Refer to table 2
Life/ Endurance	MIL-STD-202 Method 108A IEC 60115-1 4.25.1	At 70±2°C for 1,000 hours; RCWV applied for 1.5 hours on and 0.5 hour off, still air required	±(1%+0.05Ω) for B/D/F tol ±(3%+0.05Ω) for J tol <100mR for jumper
High Temperature Exposure	MIL-STD-202 Method 108A IEC 60068-2-2	1,000 hours at maximum operating temperature depending on specification, unpowered.	±(1%+0.05Ω) for B/D/F tol ±(2%+0.05Ω) for J tol <50mR for jumper
Moisture Resistance	MIL-STD-202 Method 106G	Each temperature / humidity cycle is defined at 8 hours (method 106F), 3 cycles / 24 hours for 10d with 25 °C / 65 °C 95% R.H, without steps 7a & 7b, unpowered Parts mounted on test-boards, without condensation on parts	±(0.5%+0.05Ω) for B/ D/F tol ±(2%+0.05Ω) for J tol <100mR for jumper
Humidity	IEC 60115-1 4.24.2	Steady state for 1000 hours at 40 °C / 95% R.H. RCWV applied for 1.5 hours on and 0.5 hour off	±(1%+0.05Ω) for B/D/F tol ±(2%+0.05Ω) for J tol <100mR for jumper
Thermal Shock	MIL-STD-202 Method 107G	-55/+125°C Note Number of cycles required is 300. Devices mounted Maximum transfer time is 20 seconds. Dwell time is 15 minutes. Air - Air	±(0.5%+0.05Ω) for B/D/F tol ±(1%+0.05Ω) for J tol <50mR for jumper
Short Time Overload	IEC 60115-1 4.13	2.5 times RCWV or maximum overload voltage which is less for 5 seconds at room temperature	±(1%+0.05Ω) for B/D/F tol ±(2%+0.05Ω) for J tol <50mR for jumper No visible damage
Board Flex/ Bending	IEC 60115-1 4.33	Device mounted or as described only 1 board bending required bending time: 60±5 seconds 0075/0100/0201/0402:5mm; 0603/0805:3mm; 1206 and above:2mm	±(1%+0.05Ω) for B/D/F/J Tol <50mR for jumper No visible damage

TEST	TEST METHOD	PROCEDURE	REQUIREMENTS
Solderability - Wetting	J-STD-002 test B	Electrical Test not required Magnification 50X SMD conditions: 1st step: method B, aging 4 hours at 155 °C dry heat 2nd step: leadfree solder bath at 245±3 °C Dipping time: 3±0,5 seconds	Well tinned (>95% covered) No visible damage
-Leaching	J-STD-002 test D	Leadfree solder ,260°C, 30 seconds immersion time	No visible damage
-Resistance to Soldering Heat	MIL-STD-202 Method 210F IEC 60115-1 4.18	Condition B, no pre-heat of samples Leadfree solder, 260 °C ±5°C, 10 ±1 seconds immersion time Procedure 2 for SMD: devices fluxed and cleaned with isopropanol	±(0,5% +0,05Ω) for B/D/F tol. ±(1% +0,05Ω) for J tol. <50mR for jumper No visible damage

REVISION HISTORY

REVISION	DATE	CHANGE NOTIFICATION	DESCRIPTION
Version 3	Oct. 29, 2015	-	- Updated test and requirements
Version 2	Jul. 23, 2015	-	- Updated test and requirements
Version 1	Jan. 21, 2015	-	- ESD Safe Reel update
Version 0	Dec. 15, 2014	-	- First issue of this specification

“Yageo reserves all the rights for revising the content of this datasheet without further notification, as long as the products itself are unchanged. Any product change will be announced by PCN.”