

THE PART MEETS TECONN "GPO01" COMPLIANCE NEW REV.

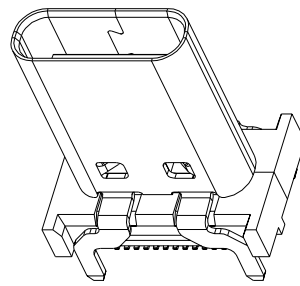

WITHOUT COVER

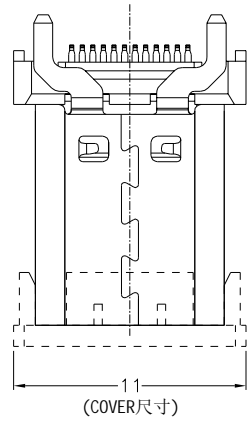
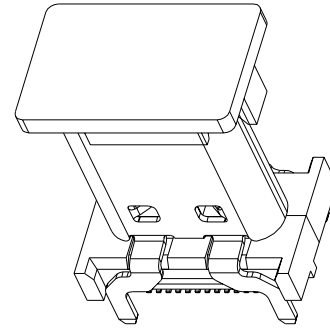

WITH COVER

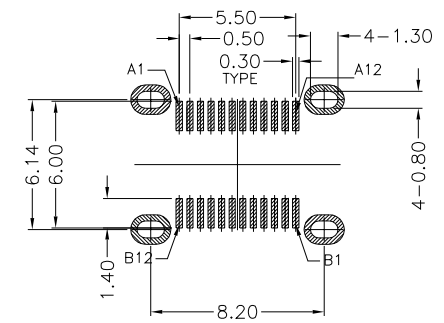

RECOMMEND P.C.B LAYOUT(COMPONENT SIDE)

TOLERANCE FOR PCB LAYOUT IS ± 0.05

KEEP OUT AREA

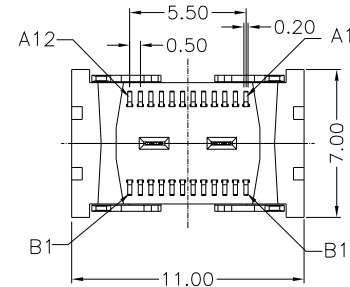
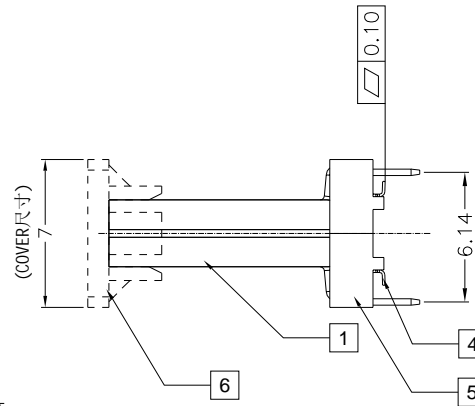
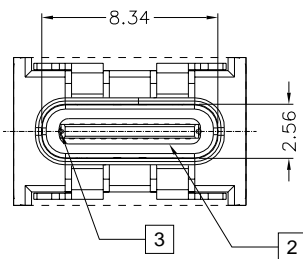

A4Q2403-A-XX-R

Mating Area plating

- 01: Au 1u"Min.
- 03: Au 3u"Min.
- 05: Au 5u"Min.
- 10: Au 10u"Min.
- 15: Au 15u"Min.
- 30: Au 30u"Min.

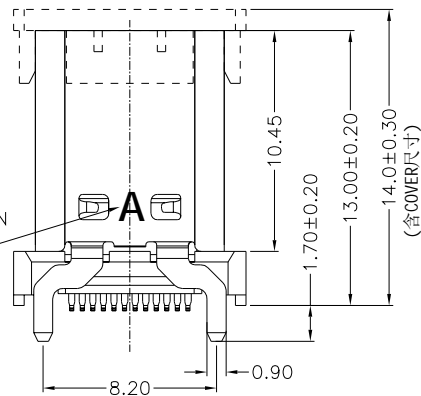

- 1.Contact Resistance:40mOHM Max.;
- 2.Dielectric Withstanding Voltage:100V AC For 1 Minute;
- 3.Insulation Resistance:100M OHM Min.;
- 4.Mating And unmating Force:
Mating Force: 5~20N
Unmating Force: 8~20N;
6~20N AFTER TEST;
- 5.Durability:10000 Cycles;

Item	Title	Material	Dispose	Q'TY
1	Shell	Stainless Steel	Ni:30u" Min.	1PCS
2	GND Plate	Stainless Steel		2PCS
3	Mid Plate	Stainless Steel		1PCS
4	Contact	Copper Alloy	Mating Area: See P/N Solder Tails: Matt Tin	2PCS
5	InsertMolding	LCP	UL 94V-0 Black	1PCS
6	COVER	LCP	UL 94V-0 Black	1PCS

X. ± 0.35	APPD: Lebon Lee	TITLE: USB 3.1 TYPE C FEMALE VERTICAL H13.0mm SMT TYPE	<p>泰康电子 TECONN</p>
.X ± 0.25	CHKD: /	PART NO: A4Q2403-A-XX-R	
.XX ± 0.15	DR: Quan Lei	DWG NO: CUSTOMER DRAWING	
.XXX ± 0.10		C-A4Q2403-A-XX-R	
X' $\pm 2'$		SCALE: 3:1	
.X' $\pm 1.5'$			SHEET:10F1 REV: A

REV	ECN NO	DESCRIPTION	DESIGN	DATE
A	TE2020-XXXX	New Drawing	Quan Lei	2020/03/30