

1.5MHz, 1.5A(peak) Synchronous Buck Regulator

Features

- **1.5A Output Peak Current**
- **Wide 3V~5.5V Input Voltage**
- **Fixed 1.5MHz Switching Frequency**
- **Low Dropout Operating at 100% Duty Cycle**
- **30mA Quiescent Current**
- **Integrate Synchronous Rectifier**
- **0.6V Reference Voltage**
- **Current-Mode Operation with Internal Compensation**
 - Stable with Ceramic Output Capacitors
 - Fast Line Transient Response
- **Short-Circuit Protection**
- **Over-Temperature Protection with Hysteresis**
- **Available in SOT-23-5/TSOT-23-5A Packages**
- **Lead Free and Green Devices Available (RoHS Compliant)**

General Description

APW7506 is a 1.5MHz high efficiency monolithic synchronous buck regulator. Design with current mode scheme, the APW7506 is stable with ceramic output capacitor. Input voltage from 3V to 5.5V makes the APW7506 ideally suited for single Li-Ion battery powered applications. 100% duty cycle provides low dropout operation, extending battery life in portable electrical devices. The internally fixed 1.5MHz operating frequency allows the using of small surface mount inductors and capacitors. The synchronous switches included inside increase the efficiency and eliminate the need of an external Schottky diode. The APW7506 is available in SOT-23-5/TSOT-23-5A packages.

Applications

- **HD STB**
- **BT Mouse**
- **PND Instrument**
- **Portable Instrument**

Pin Configuration

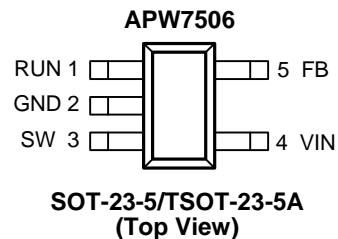

Simplified Application Circuit

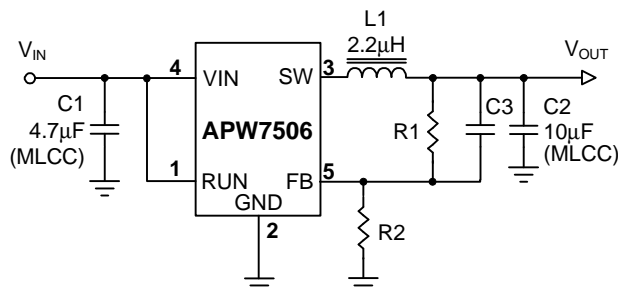

ANPEC reserves the right to make changes to improve reliability or manufacturability without notice, and advise customers to obtain the latest version of relevant information to verify before placing orders.

Ordering and Marking Information

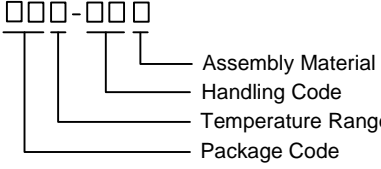
<p>APW7506 □□□-□□□</p>  <p> Assembly Material Handling Code Temperature Range Package Code </p>	<p> Package Code BT : TSOT-23-5A B : SOT-23-5 Operating Ambient Temperature Range I : -40 to 85 °C Handling Code TR : Tape & Reel Assembly Material G : Halogen and Lead Free Device </p>
APW7506 BT : W56X	X - Date Code
APW7506 B : W56X	X - Date Code

Note: ANPEC lead-free products contain molding compounds/die attach materials and 100% matte tin plate termination finish; which are fully compliant with RoHS. ANPEC lead-free products meet or exceed the lead-free requirements of IPC/JEDEC J-STD-020D for MSL classification at lead-free peak reflow temperature. ANPEC defines "Green" to mean lead-free (RoHS compliant) and halogen free (Br or Cl does not exceed 900ppm by weight in homogeneous material and total of Br and Cl does not exceed 1500ppm by weight).

Absolute Maximum Ratings (Note 1)

Symbol	Parameter	Rating	Unit
V_{IN}	Input Bias Supply Voltage (V_{IN} to GND)	-0.3 ~ 6	V
	RUN, FB, SW to GND Voltage	-0.3 ~ $V_{IN}+0.3$	V
P_D	Power Dissipation	Internally Limited	W
	Maximum Junction Temperature	150	°C
T_{STG}	Storage Temperature	-65 ~ 150	°C
T_{SDR}	Maximum Lead Soldering Temperature, 10 Seconds	260	°C

Note1: Stresses beyond those listed under "absolute maximum ratings" may cause permanent damage to the device. These are stress ratings only and functional operation of the device at these or any other conditions beyond those indicated under "recommended operating conditions" is not implied. Exposure to absolute maximum rating conditions for extended periods may affect device reliability.

Thermal Characteristics

Symbol	Parameter	Typical Value	Unit
θ_{JA}	Junction-to-Ambient Resistance in Free Air <small>(Note 2)</small>	TSOT-23-5A	220
		SOT-23-5	250
θ_{JC}	Junction to Case Resistance in free air <small>(Note 2)</small>	TSOT-23-5A	130
		SOT-23-5	130

Note 2: θ_{JA} is measured with the component mounted on a high effective thermal conductivity test board in free air.

Recommended Operating Conditions (Note 3)

Symbol	Parameter	Range	Unit
V_{IN}	Input Bias Supply Voltage (VIN to GND)	3 ~ 5.5	V
V_{OUT}	Converter Output Voltage	0.6 ~ V_{IN}	V
I_{OUT}	Maximum Peak Current, 10ms pulse, 1% duty cycle	1.5	A
	Converter Output Current	0 ~ 1.2	
L1	Converter Output Inductor	2.2 ~ 10	μ H
C_{IN}	Converter Input Capacitor	4.7 ~ 100	μ F
C_{OUT}	Converter Output Capacitor	4.7 ~ 100	μ F
T_A	Ambient Temperature	-40 ~ 85	$^{\circ}$ C
T_J	Junction Temperature	-40 ~ 125	$^{\circ}$ C

Note 3: Refer to the typical application circuit

Electrical Characteristics

Unless otherwise specified, these specifications apply over $V_{IN}=3.3\sim 5.5V$ and $T_A=25^{\circ}C$.

Symbol	Parameter	Test Conditions	APW7506			Unit
			Min.	Typ.	Max.	
SUPPLY VOLTAGE AND CURRENT						
V_{IN}	Input Voltage Range		3	-	5.5	V
I_Q	Quiescent Current	$V_{FB} = 0.66V, V_{IN}=3.3V$	-	30	60	μ A
I_{SD}	Shutdown Input Current	RUN = GND	-	-	0.5	μ A
POWER-ON-RESET (POR)						
	Rising POR Threshold		2.45	2.7	2.95	V
	POR Hysteresis		-	0.1	-	V
REFERENCE VOLTAGE						
V_{REF}	Reference Voltage		0.588	0.6	0.612	V
	Output Voltage Accuracy	$0A < I_{OUT} < 1A$	-2.5	-	+2.5	%
I_{FB}	FB Input Current		-50	-	50	nA
INTERNAL POWER MOSFETS						
F_{SW}	Switching Frequency	$V_{FB} = 0.6V$	1.2	1.5	1.9	MHz
	Foldback Frequency	$V_{FB} = 0.1V$	-	210	-	kHz
	Foldback Threshold Voltage on FB	V_{FB} Falling	-	0.2	-	V
	Foldback Hysteresis		-	50	-	mV
R_{P-FET}	High Side P-FET Switch ON Resistance	$I_{SW}=200mA$	-	0.26	-	Ω
R_{N-FET}	Low Side N-FET Switch ON Resistance	$I_{SW}=200mA$	-	0.23	-	Ω
	Minimum On-Time		-	-	100	ns
	Maximum Duty Cycle		-	-	100	%
PROTECTION						
I_{LM}	Maximum Inductor Current-Limit	$I_{P-FET}, V_{IN} = 3.3\sim 5.5V$	1.7	2.3	-	A
T_{OTP}	Over-Temperature Protection	T_J Rising <small>(Note 4)</small>	-	150	-	$^{\circ}$ C
	Over-Temperature Protection Hysteresis	<small>(Note 4)</small>	-	30	-	

Electrical Characteristics

Unless otherwise specified, these specifications apply over $V_{IN}=3.3\sim 5.5V$ and $T_A=25\text{ }^\circ C$.

Symbol	Parameter	Test Conditions	APW7506			Unit
			Min.	Typ.	Max.	
START-UP AND SHUTDOWN						
tss	Soft-Start Duration	(Note 4)	-	0.7	-	ms
	RUN Input High Threshold		-	-	1	V
	RUN Input Low Threshold		0.4	-	-	V
	RUN Leakage Current	$V_{RUN} = 5V, V_{IN} = 5V$	-1	-	1	μA

Note 4: Guarantee by design, not production test.

Typical Operating Characteristics

Efficiency vs. Load Current

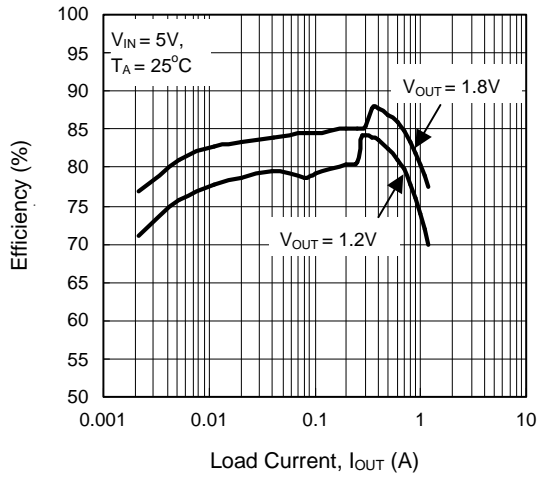

Efficiency vs. Load Current

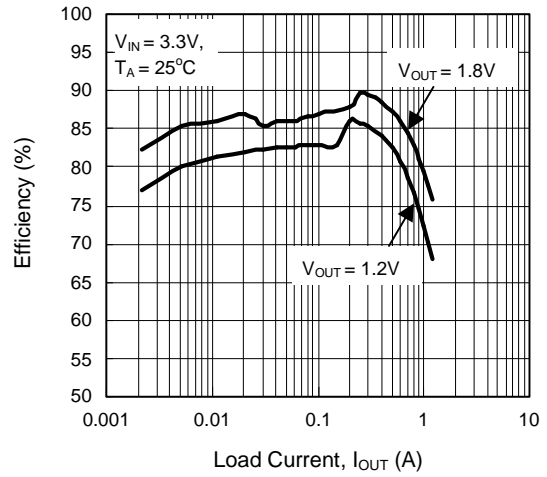

Quiescent Current vs. Junction Temperature

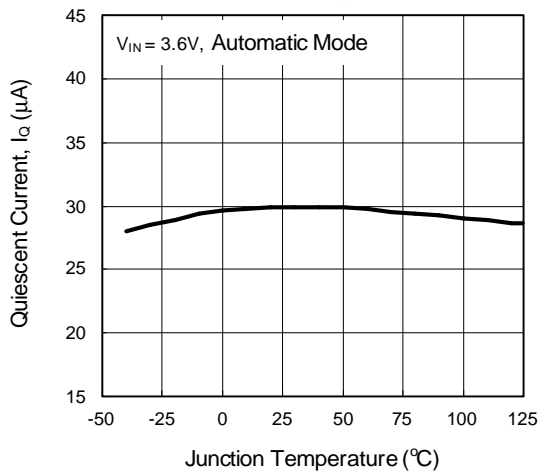

Reference Voltage vs. Junction Temperature

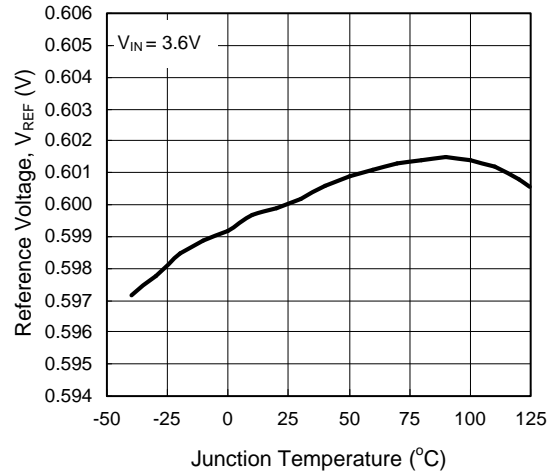

Switching Frequency vs. Junction Temperature

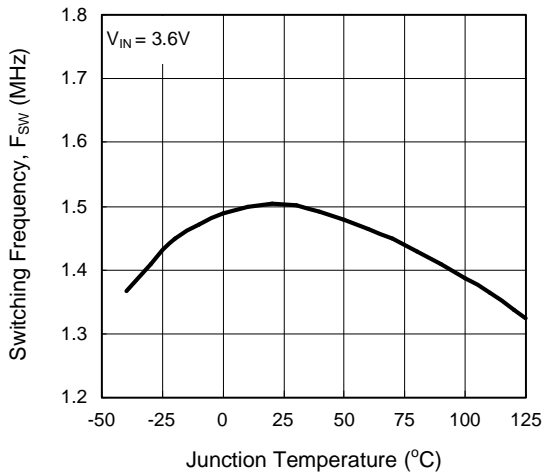

Maximum Inductor Current-Limit vs. Junction Temperature

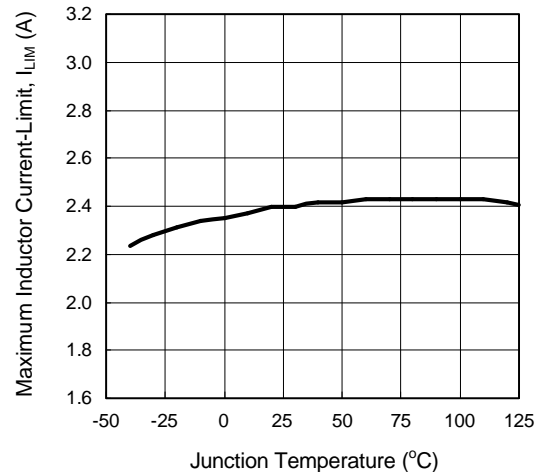

Typical Operating Characteristics

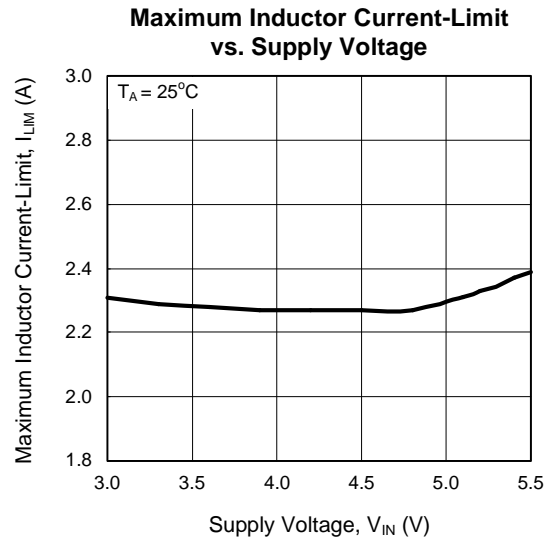
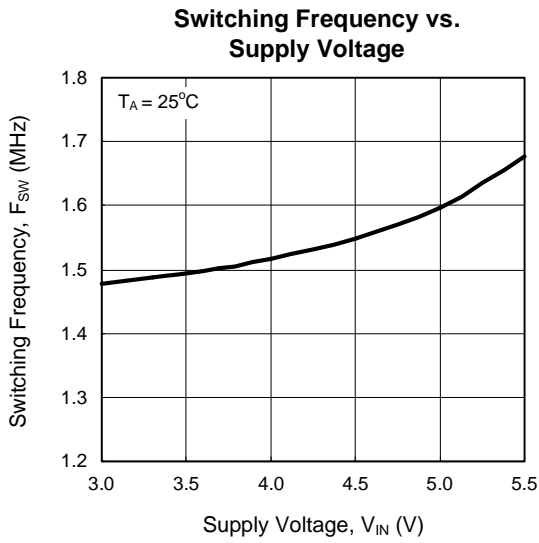

Operating Waveforms

Refer to the typical application circuit. The test condition is $V_{IN}=5V$, $V_{OUT}=1.2V$, $T_A=25^\circ C$ unless otherwise specified.

Soft-Start

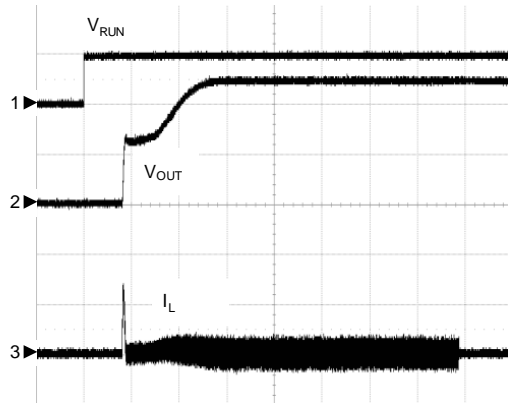

No load
 CH1: V_{RUN} , 5V/Div, DC
 CH2: V_{OUT} , 500mV/Div, DC
 CH3: I_L , 0.5A/Div, DC
 TIME: 200 μ s/Div

Load Transient Response

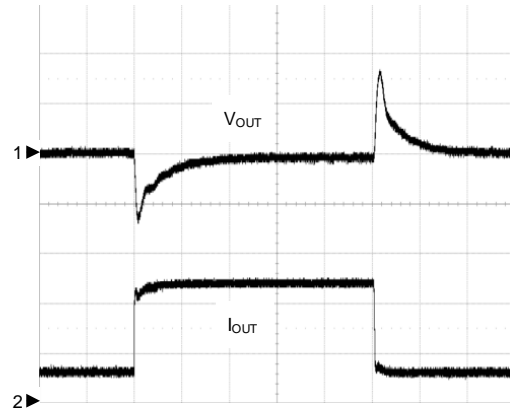

$I_{OUT}=0.3A$ to $1.2A$ to $0.3A$ (rise / fall time = 0.5μ s)
 CH1: V_{OUT} , 100mV/Div, DC offset 1.2V
 CH2: I_{OUT} , 0.5A/Div, DC
 TIME: 20 μ s/Div

Normal Operation

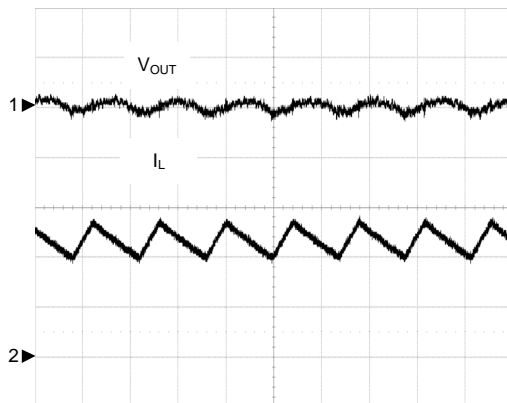

$I_{OUT}=1.2A$
 CH1: V_{OUT} , 20mV/Div, DC offset 1.2V
 CH2: I_L , 0.5A/Div, DC
 TIME: 500ns/Div

Pin Description

PIN		FUNCTION
NO.	NAME	
1	RUN	Enable Control Input. Forcing this pin above 1.0V enables the device. Forcing this pin below 0.4V shuts it down. In shutdown, all functions are disabled to decrease the supply current below 0.5μA. Do not leave RUN pin floating.
2	GND	Power and Signal Ground.
3	SW	Switch Node Connected to Inductor. This pin connects to the drains of the internal main and synchronous power MOSFETs switches.
4	VIN	Device and Converter Supply Pin. Must be closely decoupled to GND with a 4.7μF or greater ceramic capacitor.
5	FB	Feedback Input Pin. The buck regulator senses feedback voltage via FB and regulates the FB voltage at 0.6V. Connecting FB with a resistor-divider from the output sets the output voltage of the buck converter.

Block Diagram

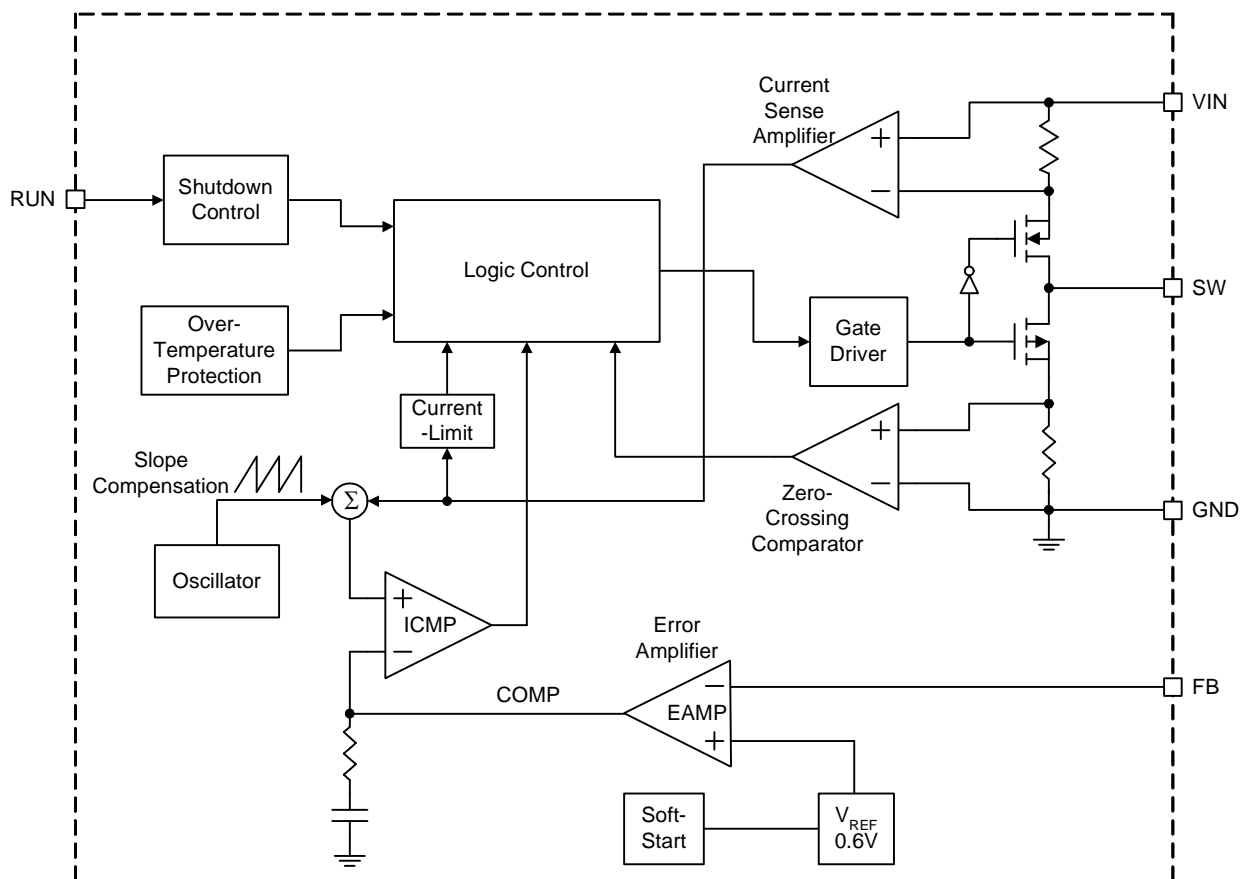

Typical Application Circuit

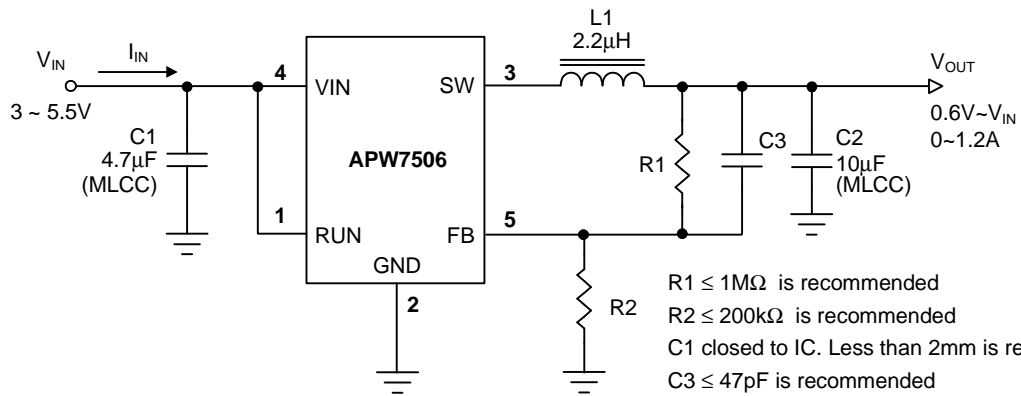

Function Description

Main Control Loop

The APW7506 is a constant frequency, synchronous rectifier and current-mode switching regulator. In normal operation, the internal P-channel power MOSFET is turned on each cycle. The peak inductor current at which ICMP turn off the P-FET is controlled by the voltage on the COMP node, which is the output of the error amplifier (EAMP). An external resistive divider connected between V_{OUT} and ground allows the EAMP to receive an output feedback voltage V_{FB} at FB pin. When the load current increases, it causes a slightly decrease in V_{FB} relative to the 0.6V reference, which in turn causes the COMP voltage to increase until the average inductor current matches the new load current.

Power-On-Reset (POR)

The APW7506 keeps monitoring the voltage on VIN pin to prevent wrong logic operations which may occur when VIN voltage is not high enough for the internal control circuitry to operate. The VIN POR has a rising threshold of 2.7V (typical) with 0.1V of hysteresis.

Soft-Start

The APW7506 has a built-in soft-start to control the output voltage rise during start-up. During soft-start, an internal ramp voltage, connected to the one of the positive inputs of the error amplifier, raises up to replace the reference voltage (0.6V typical) until the ramp voltage reaches the reference voltage. Then, the voltage on FB regulated at reference voltage.

Enable/Shutdown

Driving RUN to the ground places the APW7506 in shutdown mode. When in shutdown, the internal power MOSFETs turn off, all internal circuitry shuts down and the quiescent supply current reduces to 0.5 μ A maximum.

Pulse Frequency Modulation Mode (PFM)

The APW7506 is a fixed frequency, peak current mode PWM step-down converter. At light loads, the APW7506 will automatically enter in pulse frequency mode opera-

tion to reduce the dominant switching losses. In PFM operation, the inductor current may reach zero or reverse on each pulse. A zero current comparator turn off the N-FET, forcing DCM operation at light load. These controls get very low quiescent current, help to maintain high efficiency over the complete load range.

Slope Compensation and Inductor Peak Current

The APW7506 is a peak current mode PWM step down converter. To prevent sub-harmonic oscillations, the APW7506 sense the peak current and add slope compensation to stable the converter. It is accomplished internally by adding a compensating ramp to the inductor current signal at duty cycles in excess of 40%. Normally, this results in a reduction of maximum inductor peak current for duty cycles > 40%. However, the APW7506 uses a special scheme that counteracts this compensating ramp, which allows the maximum inductor peak current to remain unaffected throughout all duty cycles.

Adaptive Shoot-Through Protection

The gate driver incorporates adaptive shoot-through protection to high-side and low-side MOSFETs from conducting simultaneously and shorting the input supply. This is accomplished by ensuring the falling gate has turned off one MOSFET before the other is allowed to rise.

During turn-off the low-side MOSFET, the internal LGATE voltage is monitored until it is below 1.5V threshold, at which time the UGATE is released to rise after a constant delay. During turn-off the high-side MOSFET, the UGATE voltage is also monitored until it is above 1.5V threshold, at which time the LGATE is released to rise after a constant delay.

Function Description (Cont.)

Over-Temperature Protection (OTP)

The over-temperature circuit limits the junction temperature of the APW7506. When the junction temperature exceeds 150°C, a thermal sensor turns off the both power MOSFETs, allowing the devices to cool. The thermal sensor allows the converters to start a soft-start process and regulate the output voltage again after the junction temperature cools by 30°C. The OTP is designed with a 30°C hysteresis to lower the average Junction Temperature (T_j) during continuous thermal overload conditions, increasing the lifetime of the device.

Short-Circuit Protection

When the output is shortened to the ground, the frequency of the oscillator is reduced to about 210kHz, 1/7 of the nominal frequency. This frequency foldback ensures that the inductor current has more time to decay, thereby preventing runaway. The oscillator's frequency will progressively increase to 1.5MHz when V_{FB} or V_{OUT} rises above 0V.

Application Information

Input Capacitor Selection

Because buck converters have a pulsating input current, a low ESR input capacitor is required. This results in the best input voltage filtering, minimizing the interference with other circuits caused by high input voltage spikes. Also, the input capacitor must be sufficiently large to stabilize the input voltage during heavy load transients. For good input voltage filtering, usually a 4.7µF input capacitor is sufficient. It can be increased without any limit for better input-voltage filtering. Ceramic capacitors show better performance because of the low ESR value, and they are less sensitive against voltage transients and spikes compared to tantalum capacitors. Place the input capacitor as close as possible to the input and GND pin of the device for better performance.

Inductor Selection

For high efficiencies, the inductor should have a low DC resistance to minimize conduction losses. Especially at high-switching frequencies, the core material has a higher impact on efficiency. When using small chip inductors, the efficiency is reduced mainly due to higher inductor core losses. This needs to be considered when selecting the appropriate inductor. The inductor value determines the inductor ripple current. The larger the inductor value, the smaller the inductor ripple current and the lower the conduction losses of the converter. Conversely, larger inductor values cause a slower load transient response. A reasonable starting point for setting ripple current, ΔI_L is 40% of maximum output current. The recommended inductor value can be calculated as below:

$$L \geq \frac{V_{OUT} \left(1 - \frac{V_{OUT}}{V_{IN}} \right)}{F_{SW} \cdot \Delta I_L}$$

$$I_{L(MAX)} = I_{OUT(MAX)} + 1/2 \times \Delta I_L$$

To avoid the saturation of the inductor, the inductor should be rated at least for the maximum output current of the converter plus the inductor ripple current.

Output Voltage Setting

In the adjustable version, the output voltage is set by a resistive divider. The external resistive divider is connected to the output, allowing remote voltage sensing as

shown in “Typical Application Circuits”. A suggestion of maximum value of R2 is 200kΩ to keep the minimum current that provides enough noise rejection ability through the resistor divider. The output voltage can be calculated as below:

$$V_{OUT} = V_{REF} \cdot \left(1 + \frac{R1}{R2} \right) = 0.6 \cdot \left(1 + \frac{R1}{R2} \right)$$

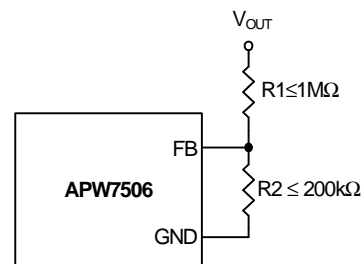

Output Capacitor Selection

The current-mode control scheme of the APW7506 allows the use of tiny ceramic capacitors. The higher capacitor value provides the good load transients response. Ceramic capacitors with low ESR values have the lowest output voltage ripple and are recommended. If required, tantalum capacitors may be used as well. The output ripple is the sum of the voltages across the ESR and the ideal output capacitor.

$$\Delta V_{OUT} \cong \frac{V_{OUT} \cdot \left(1 - \frac{V_{OUT}}{V_{IN}} \right)}{F_{SW} \cdot L} \cdot \left(ESR + \frac{1}{8 \cdot F_{SW} \cdot C_{OUT}} \right)$$

When choosing the input and output ceramic capacitors, choose the X5R or X7R dielectric formulations. These dielectrics have the best temperature and voltage characteristics of all the ceramics for a given value and size.

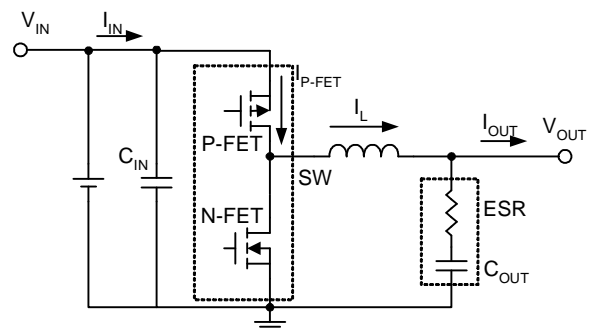

Application Information (Cont.)

Output Capacitor Selection (Cont.)

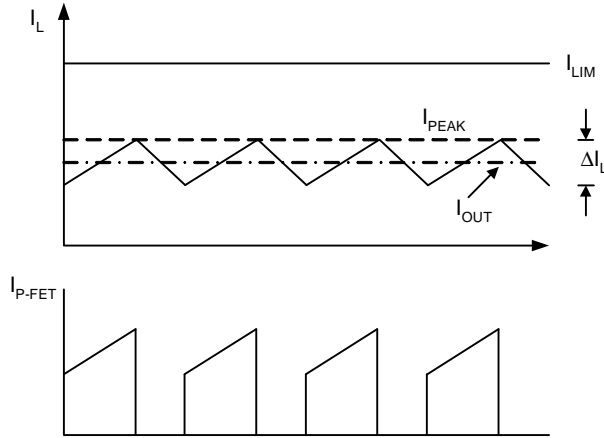

Thermal Consideration

In most applications, the APW7506 does not dissipate much heat due to its high efficiency. But, in applications where the APW7506 is running at high ambient temperature with low supply voltage and high duty cycles, the heat dissipated may exceed the maximum junction temperature of the part. If the junction temperature reaches approximately 150°C, both power switches will be turned off and the SW node will become high impedance.

To avoid the APW7506 from exceeding the maximum junction temperature, the user will need to do some thermal analysis. The goal of the thermal analysis is to determine whether the power dissipated exceeds the maximum junction temperature of the part. The power dissipated by the part is approximated:

$$P_D \cong I_{OUT}^2 \times (R_{P-FET} \times D + R_{N-FET} \times (1-D))$$

The temperature rise is given by:

$$T_R = (P_D)(\theta_{JA})$$

Where P_D is the power dissipated by the regulator, D is duty cycle of main switch

$$D = V_{OUT} / V_{IN}$$

The θ_{JA} is the thermal resistance from the junction of the die to the ambient temperature. The junction temperature, T_J , is given by:

$$T_J = T_A + T_R$$

Where T_A is the ambient temperature.

The maximum power dissipation on the device can be shown as follow figure:

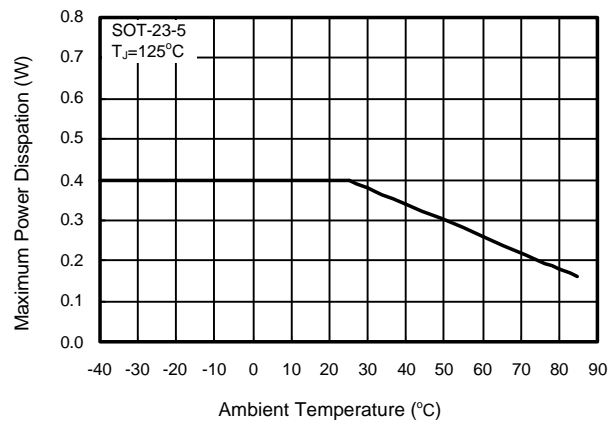
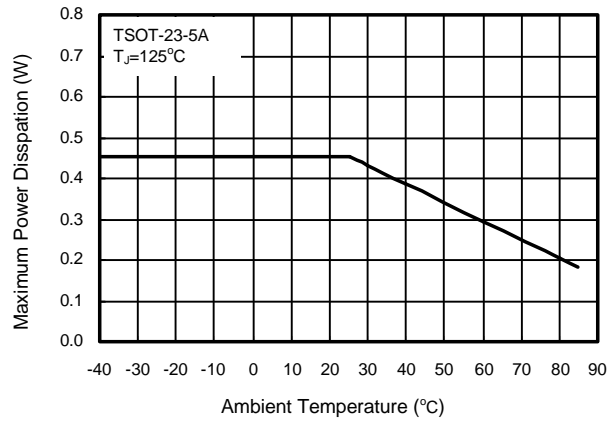

Layout Consideration

For all switching power supplies, the layout is an important step in the design; especially at high peak currents and switching frequencies. If the layout is not carefully done, the regulator might show noise problems and duty cycle jitter.

1. The input capacitor should be placed close to the VIN and GND. Connecting the capacitor and VIN/GND with short and wide trace without any via holes for good input voltage filtering. The distance between VIN/GND to capacitor less than 2mm respectively is recommended.
2. To minimize copper trace connections that can inject noise into the system, the inductor should be placed as close as possible to the SW pin to minimize the noise coupling into other circuits.

Layout Consideration (cont.)

3. The output capacitor should be placed close to converter V_{OUT} and GND.
4. Since the feedback pin and network is a high impedance circuit the feedback network should be routed away from the inductor. The feedback pin and feedback network should be shielded with a ground plane or trace to minimize noise coupling into this circuit.
5. A star ground connection or ground plane minimizes ground shifts and noise is recommended.

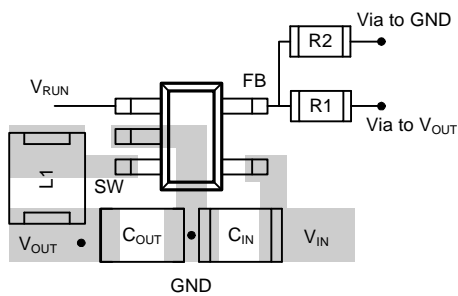

APW7506 Layout Suggestion

Package Information

TSOT-23-5A

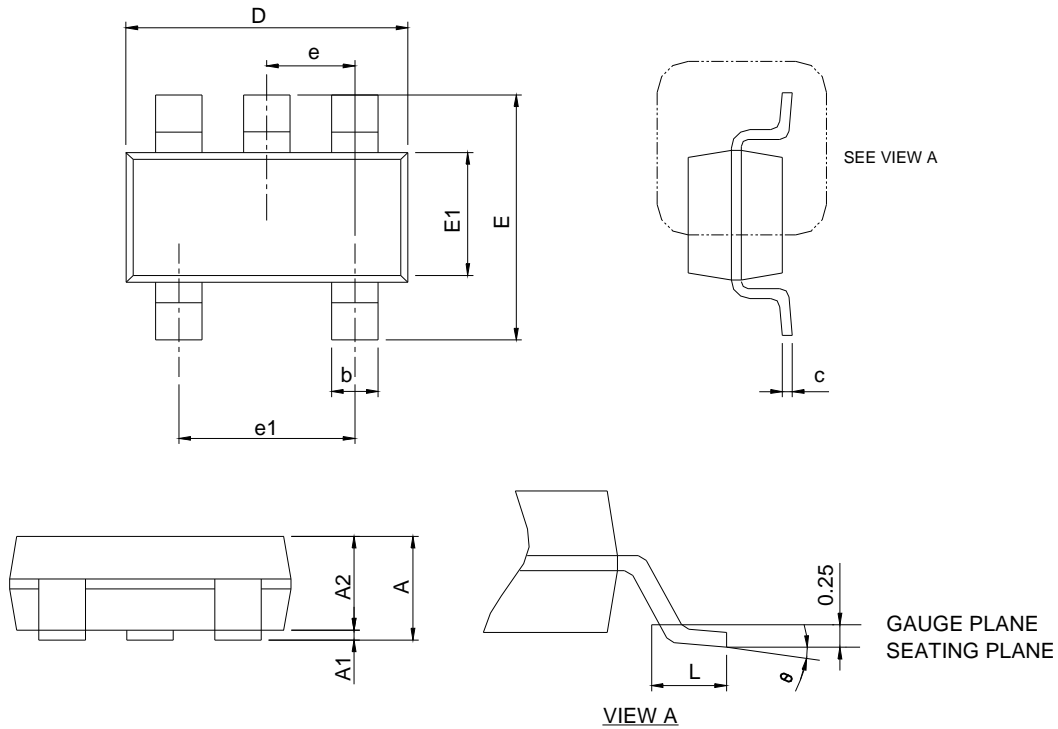

SYMBOL	TSOT-23-5A			
	MILLIMETERS		INCHES	
	MIN.	MAX.	MIN.	MAX.
A	0.70	1.00	0.028	0.039
A1	0.01	0.10	0.000	0.004
A2	0.70	0.90	0.028	0.035
b	0.30	0.50	0.012	0.020
c	0.08	0.22	0.003	0.009
D	2.70	3.10	0.106	0.122
E	2.60	3.00	0.102	0.118
E1	1.40	1.80	0.055	0.071
e	0.95 BSC		0.037 BSC	
e1	1.90BSC		0.075 BSC	
L	0.30	0.60	0.012	0.024
θ	0°	8°	0°	8°

Note : 1. Followed from JEDEC TO-178 AA.
 2. Dimension D and E1 do not include mold flash, protrusions or gate burrs. Mold flash, protrusion or gate burrs shall not exceed 10 mil per side.

Package Information

SOT-23-5

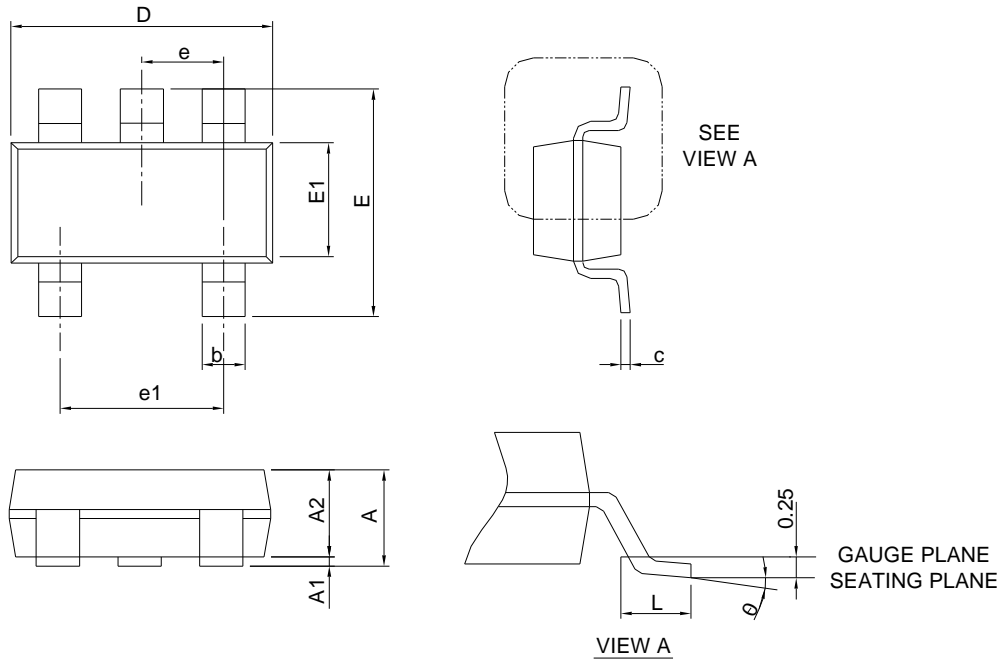

DIMENSION	SOT-23-5			
	MILLIMETERS		INCHES	
	MIN.	MAX.	MIN.	MAX.
A		1.45		0.057
A1	0.00	0.15	0.000	0.006
A2	0.90	1.30	0.035	0.051
b	0.30	0.50	0.012	0.020
c	0.08	0.22	0.003	0.009
D	2.70	3.10	0.106	0.122
E	2.60	3.00	0.102	0.118
E1	1.40	1.80	0.055	0.071
e	0.95 BSC		0.037 BSC	
e1	1.90 BSC		0.075 BSC	
L	0.30	0.60	0.012	0.024
θ	0°	8°	0°	8°

Note : 1. Follow JEDEC TO-178 AA.
 2. Dimension D and E1 do not include mold flash, protrusions or gate burrs. Mold flash, protrusion or gate burrs shall not exceed 10 mil per side.

Carrier Tape & Reel Dimensions

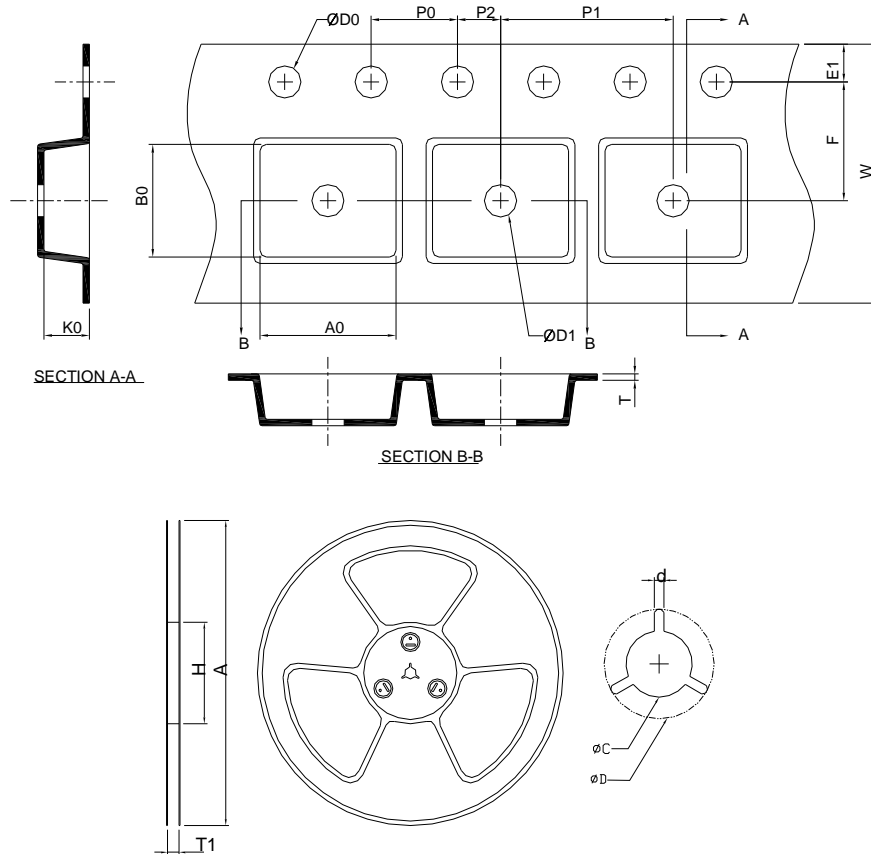

Application	A	H	T1	C	d	D	W	E1	F
TSOT-23-5A	178.0±2.00	50 MIN.	8.4+2.00 -0.00	13.0+0.50 -0.20	1.5 MIN.	20.2 MIN.	8.0±0.30	1.75±0.10	3.5±0.05
	P0	P1	P2	D0	D1	T	A0	B0	K0
	4.0±0.10	4.0±0.10	2.0±0.05	1.5+0.10 -0.00	1.0 MIN.	0.6+0.00 -0.40	3.20±0.20	3.10±0.20	1.50±0.20
Application	A	H	T1	C	d	D	W	E1	F
SOT-23-5	178.0±2.00	50 MIN.	8.4+2.00 -0.00	13.0+0.50 -0.20	1.5 MIN.	20.2 MIN.	8.0±0.30	1.75±0.10	3.5±0.05
	P0	P1	P2	D0	D1	T	A0	B0	K0
	4.0±0.10	4.0±0.10	2.0±0.05	1.5+0.10 -0.00	1.0 MIN.	0.6+0.00 -0.40	3.20±0.20	3.10±0.20	1.50±0.20

(mm)

Devices Per Unit

Package Type	Unit	Quantity
TSOT-23-5A	Tape & Reel	3000
SOT-23-5	Tape & Reel	3000

Taping Direction Information

TSOT-23-5A

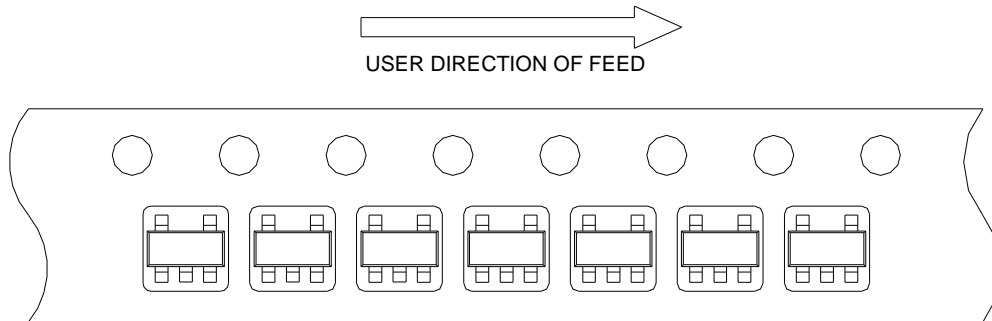

SOT-23-5

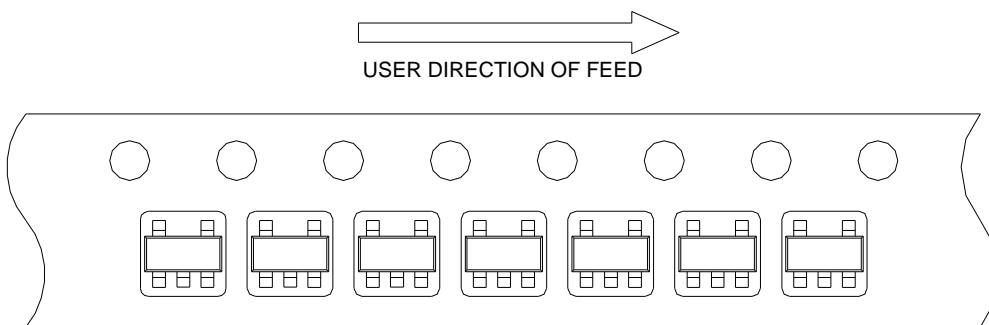

Classification Profile

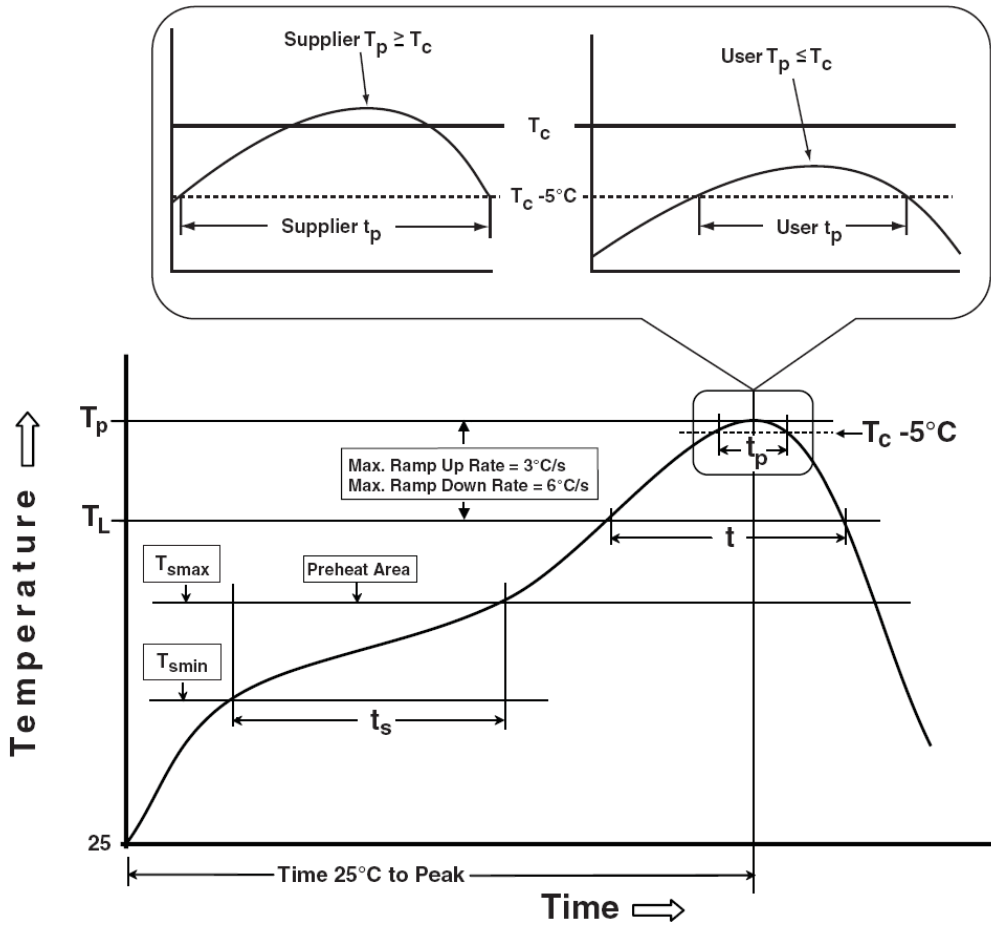

Classification Reflow Profiles

Profile Feature	Sn-Pb Eutectic Assembly	Pb-Free Assembly
Preheat & Soak		
Temperature min (T_{smin})	100 °C	150 °C
Temperature max (T_{smax})	150 °C	200 °C
Time (T_{smin} to T_{smax}) (t_s)	60-120 seconds	60-120 seconds
Average ramp-up rate (T_{smax} to T_p)	3 °C/second max.	3 °C/second max.
Liquidous temperature (T_L)	183 °C	217 °C
Time at liquidous (t_L)	60-150 seconds	60-150 seconds
Peak package body Temperature (T_p)*	See Classification Temp in table 1	See Classification Temp in table 2
Time (t_p)** within 5°C of the specified classification temperature (T_c)	20** seconds	30** seconds
Average ramp-down rate (T_p to T_{smax})	6 °C/second max.	6 °C/second max.
Time 25°C to peak temperature	6 minutes max.	8 minutes max.
* Tolerance for peak profile Temperature (T_p) is defined as a supplier minimum and a user maximum.		
** Tolerance for time at peak profile temperature (t_p) is defined as a supplier minimum and a user maximum.		

Classification Reflow Profiles (Cont.)

Table 1. SnPb Eutectic Process – Classification Temperatures (Tc)

Package Thickness	Volume mm ³ <350	Volume mm ³ ≥350
<2.5 mm	235 °C	220 °C
≥2.5 mm	220 °C	220 °C

Table 2. Pb-free Process – Classification Temperatures (Tc)

Package Thickness	Volume mm ³ <350	Volume mm ³ 350-2000	Volume mm ³ >2000
<1.6 mm	260 °C	260 °C	260 °C
1.6 mm – 2.5 mm	260 °C	250 °C	245 °C
≥2.5 mm	250 °C	245 °C	245 °C

Reliability Test Program

Test item	Method	Description
SOLDERABILITY	JESD-22, B102	5 Sec, 245°C
HOLT	JESD-22, A108	1000 Hrs, Bias @ Tj=125°C
PCT	JESD-22, A102	168 Hrs, 100%RH, 2atm, 121°C
TCT	JESD-22, A104	500 Cycles, -65°C~150°C
HBM	MIL-STD-883-3015.7	VHBM ≥ 2KV
MM	JESD-22, A115	VMM ≥ 200V
Latch-Up	JESD 78	10ms, 1 _{tr} ≥ 100mA

Customer Service

Anpec Electronics Corp.

Head Office :

No.6, Dusing 1st Road, SBIP,
Hsin-Chu, Taiwan, R.O.C.
Tel : 886-3-5642000
Fax : 886-3-5642050

Taipei Branch :

2F, No. 11, Lane 218, Sec 2 Jhongsing Rd.,
Sindian City, Taipei County 23146, Taiwan
Tel : 886-2-2910-3838
Fax : 886-2-2917-3838