

## Features

- Ultra low leakage: nA level
- Operating voltage: 5V
- Low clamping voltage
- Complies with following standards:
  - IEC 61000-4-2 (ESD) immunity test
    - Air discharge:  $\pm 20\text{kV}$
    - Contact discharge:  $\pm 20\text{kV}$
  - IEC61000-4-4 (EFT) 40A (5/50ns)
  - IEC61000-4-5 (Lightning) 3A (8/20 $\mu\text{s}$ )
- RoHS Compliant

## Applications

- Cellular Handsets and Accessories
- Notebooks and Handhelds
- Personal Digital Assistants
- Portable Instrumentation
- Digital Cameras
- Peripherals
- Audio Players, Keypads, Side Keys, LCD
- USB 2.0

## Mechanical Characteristics

- Package: SOT-143
- Lead Finish: Matte Tin
- Case Material: "Green" Molding Compound.
- Moisture Sensitivity: Level 3 per J-STD-020
- Terminal Connections: See Diagram Below
- Marking Information: See Below

## Absolute Maximum Ratings (T<sub>amb</sub>=25°C unless otherwise specified)

Parameter	Symbol	Value	Unit
Peak Pulse Power (8/20 $\mu\text{s}$ )	P <sub>pp</sub>	50	W
ESD per IEC 61000-4-2 (Air)	V <sub>ESD</sub>	$\pm 20$	Kv
ESD per IEC 61000-4-2 (Contact)		$\pm 20$	
Operating Temperature Range	T <sub>J</sub>	-55 to +125	°C
Storage Temperature Range	T <sub>STJ</sub>	-55 to +150	°C

## Dimensions SOT-143

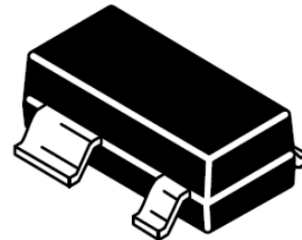

## Pin Configuration

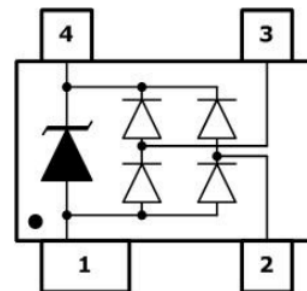

**Electrical Characteristics**(TA=25°C unless otherwise specified)

Part Number	Device Marking	V <sub>RWM</sub> (V)	V <sub>BR</sub> (V)	I <sub>T</sub> (mA)	V <sub>C</sub> @1A	V <sub>C</sub>		I <sub>R</sub> μA (Max)	C (Pf) (Typ.)
						(Max)	(@A)		
SR05L	U5V0	5	6	1	10	17	3	0.5	0.45

Typical Performance Characteristics ( $T_A=25^{\circ}\text{C}$  unless otherwise Specified)

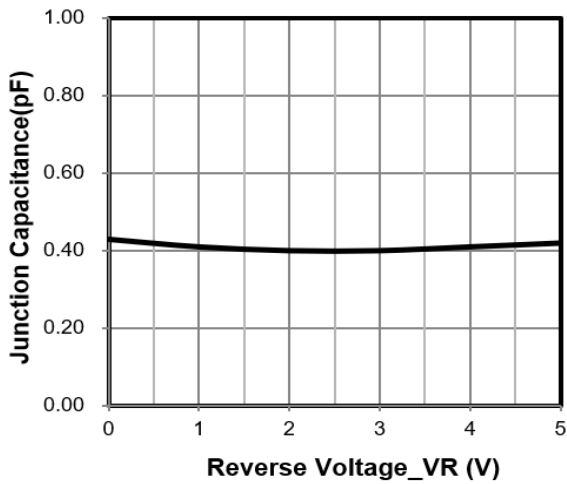

Junction Capacitance vs. Reverse Voltage

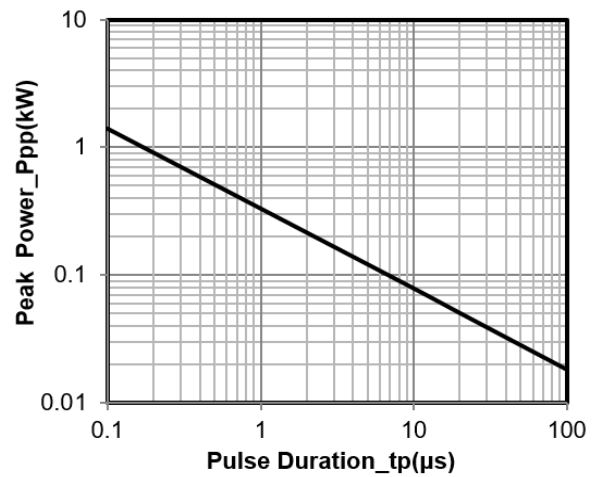

Peak Pulse Power vs. Pulse Time

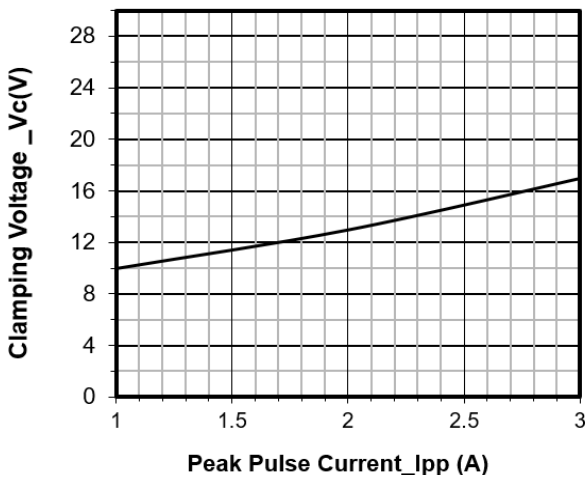

Clamping Voltage vs. Peak Pulse Current

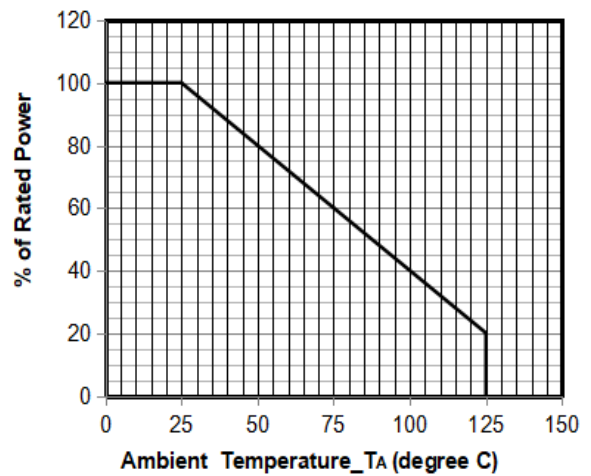

Power Derating Curve

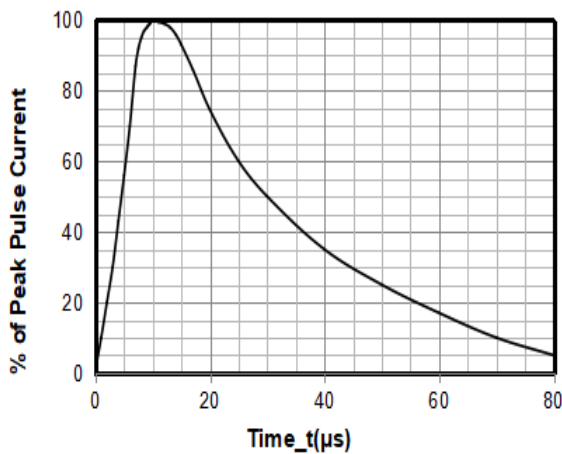

8 X 20μs Pulse Waveform

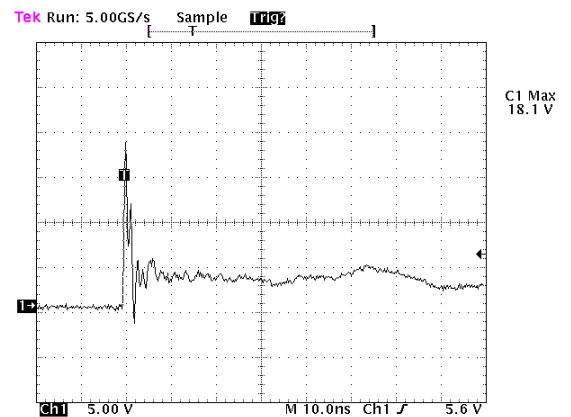

Note: Data is taken with a 10x attenuator

ESD Clamping Voltage

8 kV Contact per IEC61000-4-2

SOT-143 Package Outline & Dimensions

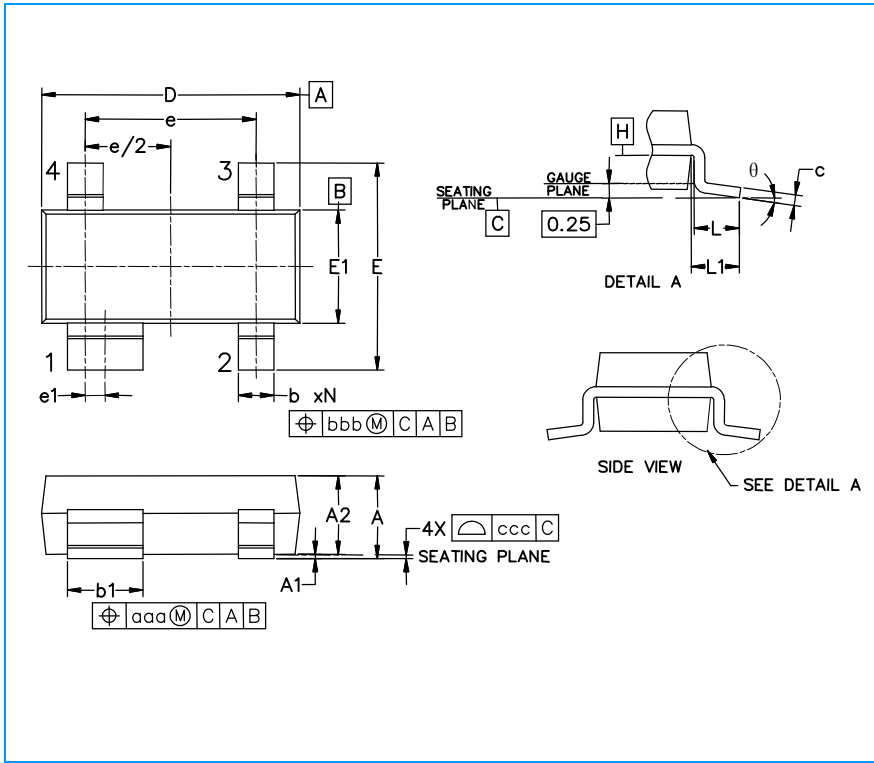

Symbol	Inches			Millimeters		
	Min.	Nom.	Max.	Min.	Nom.	Max.
A	0.031	-	0.048	0.80	-	1.22
A1	0.000	-	0.008	0.013	-	0.15
A2	0.020	0.035	0.042	0.75	0.90	1.07
b	0.011	-	0.020	0.30	-	0.51
b1	0.029	-	0.037	0.76	-	0.94
c	0.003	-	0.008	0.08	-	0.20
D	0.110	0.114	0.120	2.80	2.90	3.04
E	0.082	0.093	0.104	2.10	2.37	2.64
E1	0.047	0.051	0.055	1.20	1.30	1.40
e	0.075		1.92 BSC			
e1	0.008		0.20 BSC			
L	0.015	0.020	0.024	0.40	0.50	0.60
L1	(0.021)		(0.54)			
N	4		4			
theta	0°	-	8°	0°	-	8°
aaa	0.006		0.15			
bbb	0.008		0.20			
ccc	0.004		0.10			

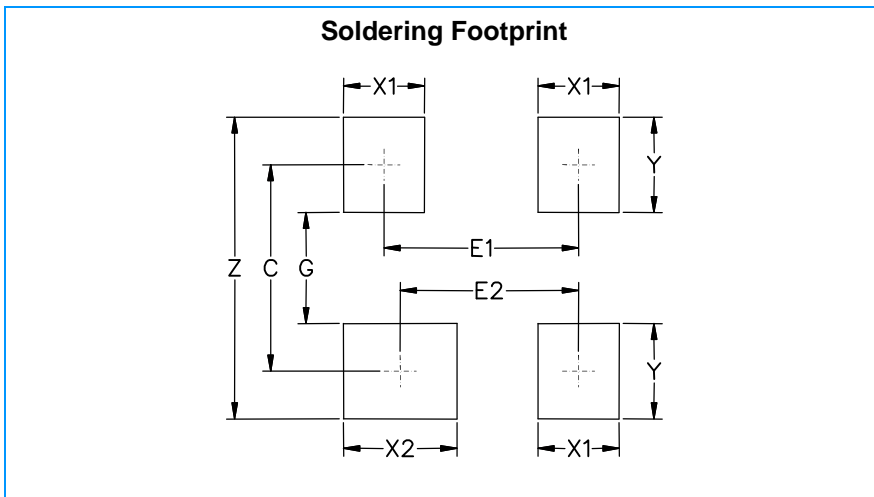

Symbol	Inches	Millimeters
C	(0.087)	(2.20)
E1	0.076	1.92
E2	0.068	1.72
G	0.031	0.80
X1	0.039	1.00
X2	0.047	1.20
Y	0.055	1.40
Z	0.141	3.60