

GENERAL DESCRIPTION

The HP6003 series are low dropout linear regulators and optimized to provide a high performance solution for battery power system to delivery low quiescent current. The device offers a new level of cost effective performance in cellular phones, laptop and notebook computers, and other portable devices.

HP6003 can provide output value in the range of 1.0V~3.6V by every 0.1V step.

The HP6003 series are designed to make use of low cost ceramic capacitors which ensure the stability of the output current, and enhance the efficiency in order to prolong the battery life of those portable devices.

The HP6003 regulators are available in SOT-23 packages. Standard products are Pb-free and Halogen-free.

FEATURES

- Input voltage: 2.5V~7V
- Output range: 1.0V~3.6V
(customized by every 0.1V step)
- Output current: 300mA @ $V_{IN}-V_{OUT}=1V$
- Dropout voltage: 190mV @ $I_{OUT}=100mA$
- Quiescent current : 1.5 μ A Typ.
- PSRR: 60dB @ 100Hz, 50dB @ 10kHz
- Recommend capacitor: 1 μ F

APPLICATIONS

- Reference voltage source
- Toys
- Bluetooth, wireless handsets
- Low Consumption Device
- Others portable electronic device

TYPICAL APPLIC

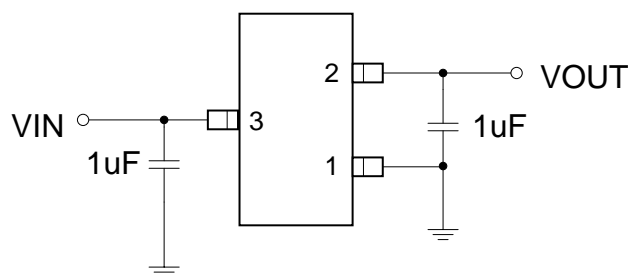

PIN ASSIGNMENT



SOT-23

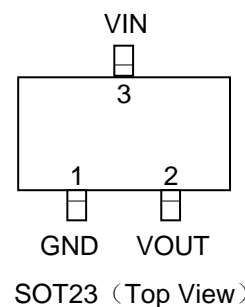

ORDER INFORMATION

PART NO	PACAKGE	TEMPERATURE	TAPE & REEL
HP6003S3-XX	SOT-23	-40 ~ +85°C	3000/REEL

Note: XX indicates 1.0V~3.6V by 0.1V step. For example, 33 means product outputs 3.3V

PART NUMBER RULES

HP6003 1 - 2

Code	Description
1	Package: S3: SOT-23
2	Voltage version: XX: 1.0V~3.6V by 0.1V step Example: 33: 3.3V

MARKING DESCRIPTION:

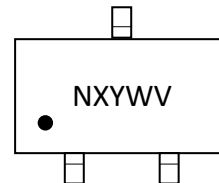

“N”: Product code, here use “S” stands for “HP6003”.

“X”: Internal Control Code

“Y”: Internal Control Code

“W”: The week of manufacturing. “A” stands for week 1, “Z” stands for week 26, “a” stands for week 27, “z” stands for week 52.

“V” : Output voltage code.

PIN DESCRIPTION

PIN NO	SYMBOL	I/O	DESCRIPTION
SOT-23			
1	GND	GND	Ground
2	VOUT	O	Output
3	VIN	Power	Input

ABSOLUTE MAXIMUM RATINGS (Note)

SYMBOL	ITEMS	VALUE	UNIT
V _{IN}	Input Voltage	-0.3~8	V
I _{OUT}	Output Current	370	mA
P _{DMAX}	Power Dissipation	SOT-23 0.25	W
R _{θJA}	Thermal Resistance	SOT-23 220	°C/W
T _J	Junction Temperature	-40~125	°C
T _A	Ambient Temperature	-40~85	°C
T _{STG}	Storage Temperature	-55~150	°C
T _{SOLDER}	Package Lead Soldering Temperature (10s)	260	°C

Note: Exceed these limits to damage to the device. Exposure to absolute maximum rating conditions may affect device reliability.

RECOMMENDED OPERATING RANGE

SYMBOL	ITEMS	VALUE	UNIT
V_{IN}	Supply Voltage	2.5 to 7	V
T_{OPT}	Operating Temperature	-40 to +85	°C

ELECTRICAL CHARACTERISTICS

The following specifications apply for $V_{OUT}=3.3V$, $T_A=25^{\circ}C$, unless otherwise noted.

SYMBOL	ITEMS	CONDITIONS	MIN	TYP	MAX	UNIT
V_{IN}	Input Voltage				7	V
V_{OUT}	Output Voltage	$V_{OUT} > 1.2V, V_{IN}=V_{OUT}+1V, I_{OUT}=1mA$	$V_{OUT} \times 0.98$	V_{OUT}	$V_{OUT} \times 1.02$	V
		$V_{OUT} \leq 1.2V, V_{IN}=2.5V, I_{OUT}=1mA$	$V_{OUT} - 25mV$	V_{OUT}	$V_{OUT} + 25mV$	
I_Q	Quiescent Current	$V_{OUT}=3.3V, I_{OUT}=0$		1.5	3	μA
I_{LIMIT}	Current Limit	$V_{IN}-V_{OUT}=0.5V$		370		mA
V_{DROP}	Dropout Voltage	$V_{OUT}=3.3V, I_{OUT}=50mA$		95		mV
		$V_{OUT}=3.3V, I_{OUT}=100mA$		190		
ΔV_{LINE}	Line Regulation	$V_{IN}=4.3 \sim 5.5V, I_{OUT}=1mA$			6	mV
ΔV_{LOAD}	Load Regulation	$V_{IN}=V_{OUT}+1V, I_{OUT}=1 \sim 300mA$			36	mV
I_{SHORT}	Short Current	V_{OUT} Short to GND with 1Ω	50	90	190	mA

SIMPLIFIED BLOCK DIAGRAM

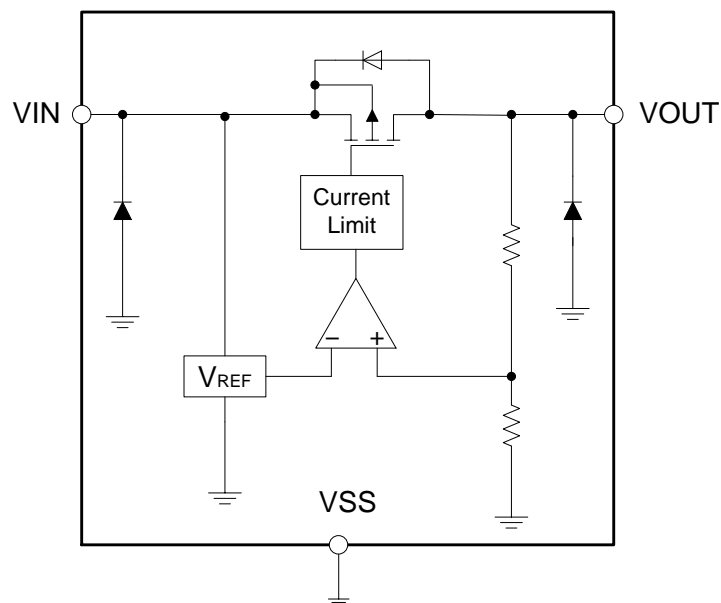

TYPICAL PERFORMANCE CHARACTERISTICS

$C_{IN}=1\mu F$, $C_{OUT}=1\mu F$, $T_{OPT}=25^{\circ}C$, $V_{IN}=5V$, $V_{OUT}=3.3V$, unless otherwise noted.

Quiescent Current vs. Input Voltage

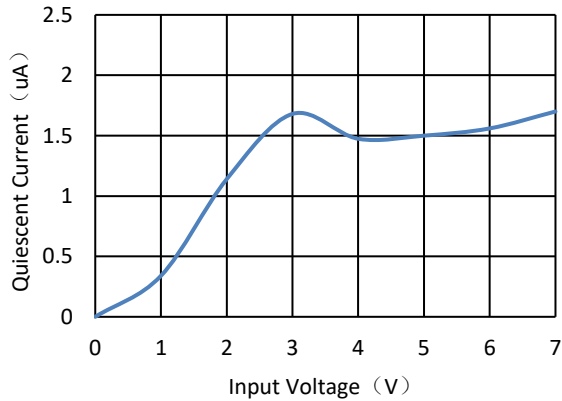

Output Voltage vs. Input Voltage

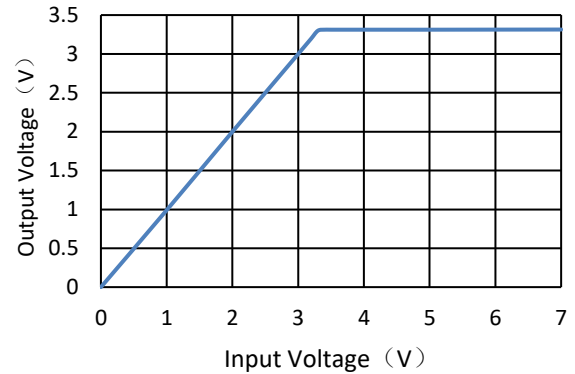

Output Voltage vs. Load Current

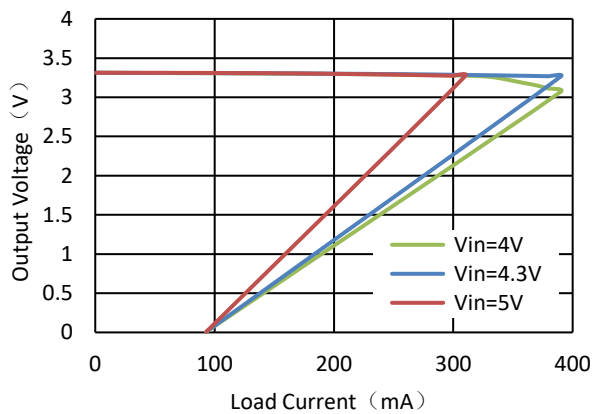

Current Limit vs. Input Voltage

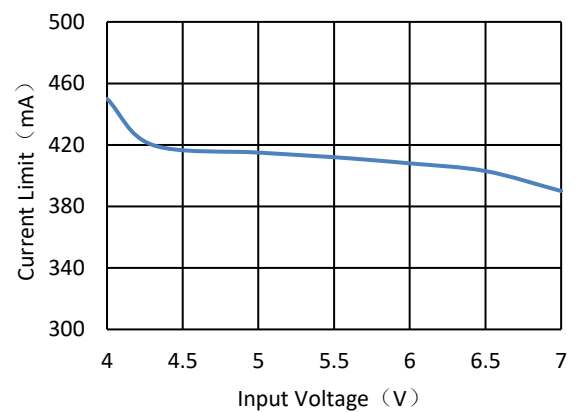

Output Voltage vs. Temperature

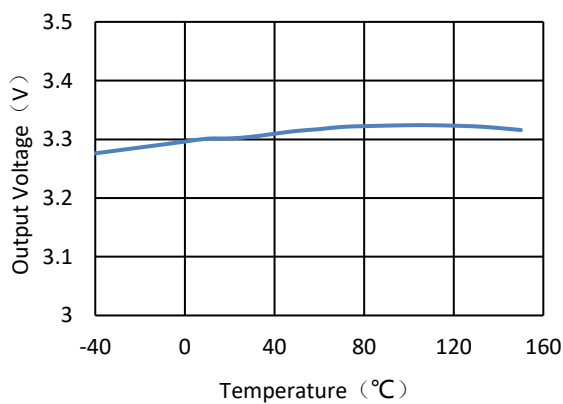

Short Current vs. Input Voltage

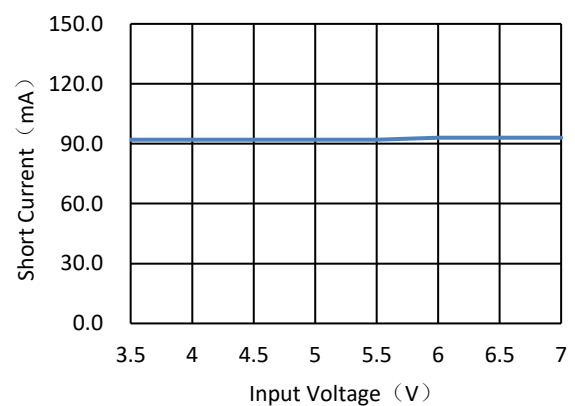

Power ON

CH1: V_{IN} CH2: V_{OUT}

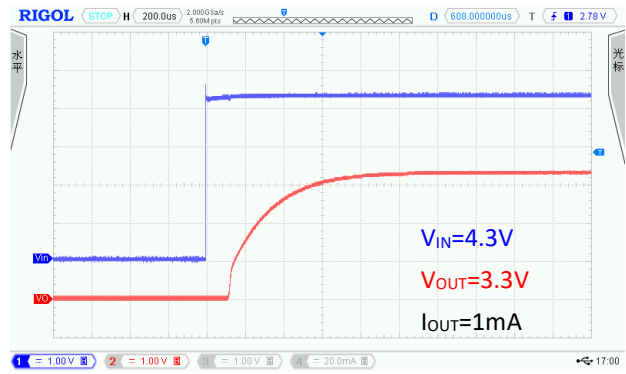
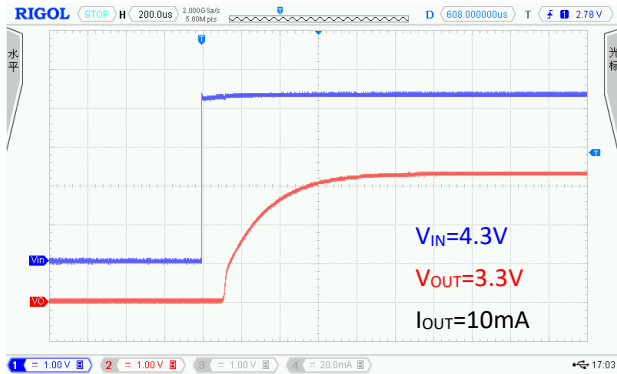

Line Transient Response

CH1: V_{IN} CH2: V_{OUT}

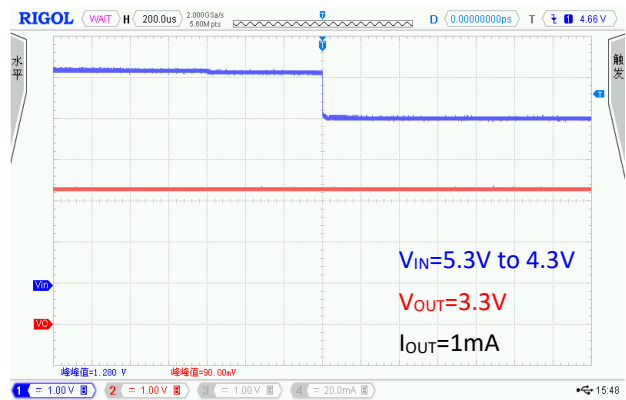
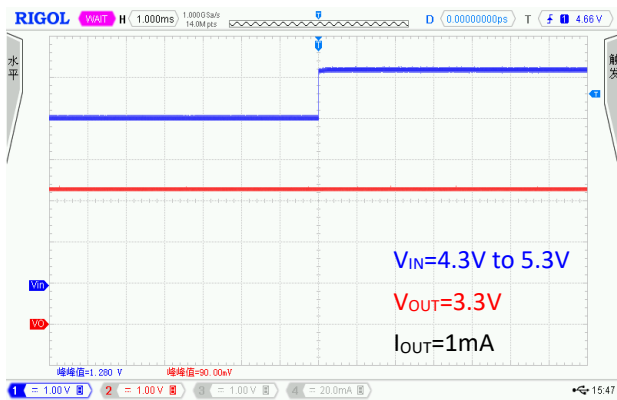
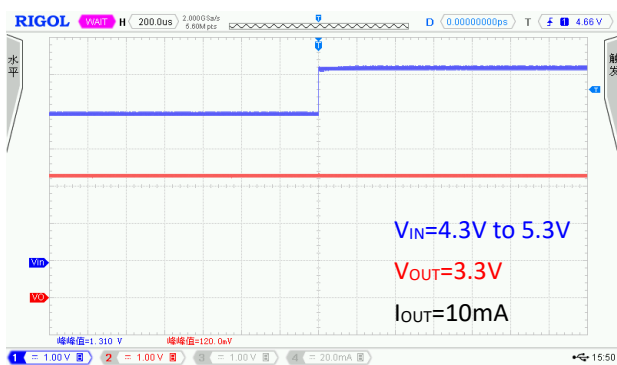

Load Transient Response

CH1: V_{IN} CH2: V_{OUT} CH4: I_{OUT}

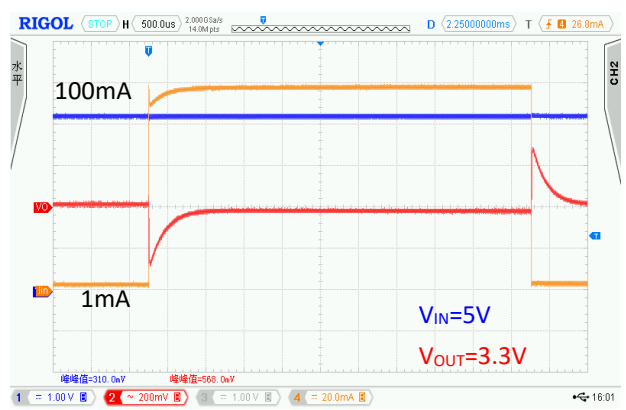
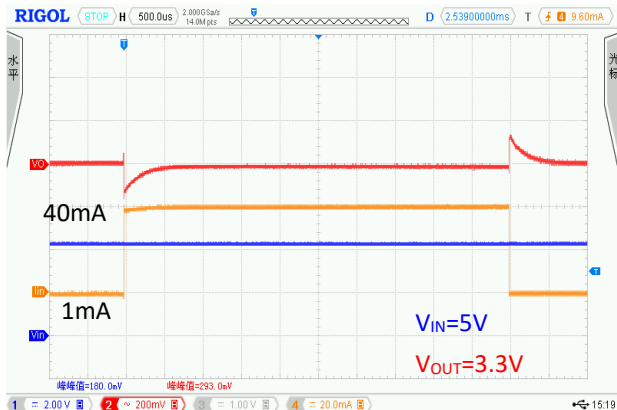

PACKAGE OUTLINE

Package	SOT-23	Devices per reel	3000Pcs	Unit	mm
Package Dimension:					
Symbol	Dimensions In Millimeters		Dimensions In Inches		
	Min	Max	Min	Max	
A	0.900	1.150	0.035	0.045	
A1	0.000	0.100	0.000	0.004	
A2	0.900	1.050	0.035	0.041	
b	0.300	0.500	0.012	0.020	
c	0.080	0.150	0.003	0.006	
D	2.800	3.000	0.110	0.118	
E	1.200	1.400	0.047	0.055	
E1	2.250	2.550	0.089	0.100	
e	0.950(BSC)		0.037(BSC)		
e1	1.800	2.000	0.071	0.079	
L	0.550(BSC)		0.022(BSC)		
L1	0.300	0.500	0.012	0.020	
θ	0°C	8°C	0°C	8°C	

REVISION HISTORY

Version No.	Date	Description
Preliminary	2017-09-30	- Initial preliminary release
Version 1.0	2017-10-23	- Update Features. - Update Electrical Characteristics. - Update Typical Performance Characteristics.
Version 1.1	2017-10-31	- Update output voltage range from 1.2~3.6V to 1.0~3.6V. - Update input voltage range from 6.5V to 7V.
Version 1.2	2018-05-29	- Update Electrical Characteristics. - Update quiescent current from 2 μ A to 1.5 μ A (TYP.)
Version 1.3	2018-11-06	- Change product code from "V" to "S"
Version 1.4	2018-12-01	- Correct PSRR data
Version 1.5	2019-12-02	- Update marking description