

BAT760WS

SCHOTTKY BARRIER DIODE

Features

- Ultra high-speed switching
- Very low forward voltage
- Very small SMD plastic package

Applications

- Ultra high-speed switching
- Voltage clamping
- Protection circuits

PINNING

PIN	DESCRIPTION
1	Cathode
2	Anode

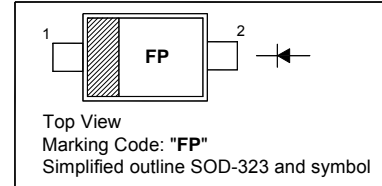

Absolute Maximum Ratings ($T_a = 25^\circ\text{C}$)

Parameter	Symbol	Value	Unit
Reverse Voltage	V_R	20	V
Continuous Forward Current	I_F	1	A
Non-repetitive Peak Forward Current (t = 8.3 ms Half Sine Wave, JEDEC method)	I_{FSM}	5	A
Junction Temperature	T_J	125	$^\circ\text{C}$
Operating Ambient Temperature Range	T_{op}	- 65 to + 125	$^\circ\text{C}$
Storage Temperature Range	T_{stg}	- 65 to + 150	$^\circ\text{C}$
Thermal Resistance from Junction to Ambient	$R_{\theta JA}$	220 ¹⁾ 180 ²⁾	K/W

¹⁾ Mounted on P.C.B. 10 X 10 mm² Cu

²⁾ Mounted on P.C.B. 40 X 40 mm² Cu

Characteristics at $T_a = 25^\circ\text{C}$

Parameter	Symbol	Typ.	Max.	Unit
Forward Voltage at $I_F = 10\text{ mA}$ at $I_F = 100\text{ mA}$ at $I_F = 1\text{ A}$	V_F	- - -	0.27 0.35 0.65	V
Reverse Current at $V_R = 5\text{ V}$ at $V_R = 8\text{ V}$ at $V_R = 15\text{ V}$	I_R	- - -	10 20 50	μA
Diode Capacitance at $V_R = 5\text{ V}$, $f = 1\text{ MHz}$	C_d	25	-	pF

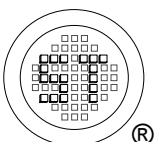

SEMTECH ELECTRONICS LTD.
Subsidiary of Sino-Tech International (BVI) Limited



BAT760WS

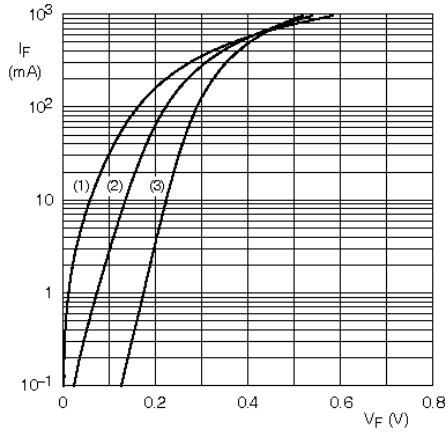

- (1) $T_{amb} = 85\text{ }^{\circ}\text{C}$.
- (2) $T_{amb} = 25\text{ }^{\circ}\text{C}$.
- (3) $T_{amb} = -40\text{ }^{\circ}\text{C}$.

Forward current as a function of forward voltage; typical values.

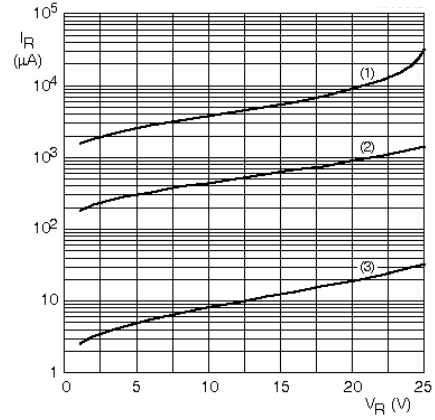

- (1) $T_{amb} = 125\text{ }^{\circ}\text{C}$.
- (2) $T_{amb} = 85\text{ }^{\circ}\text{C}$.
- (3) $T_{amb} = 25\text{ }^{\circ}\text{C}$.

Reverse current as a function of reverse voltage; typical values.

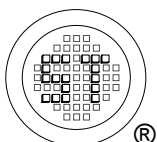

SEMTECH ELECTRONICS LTD.
Subsidiary of Sino-Tech International (BVI) Limited



BAT760WS

PACKAGE OUTLINE

Plastic surface mounted package; 2 leads

SOD-323

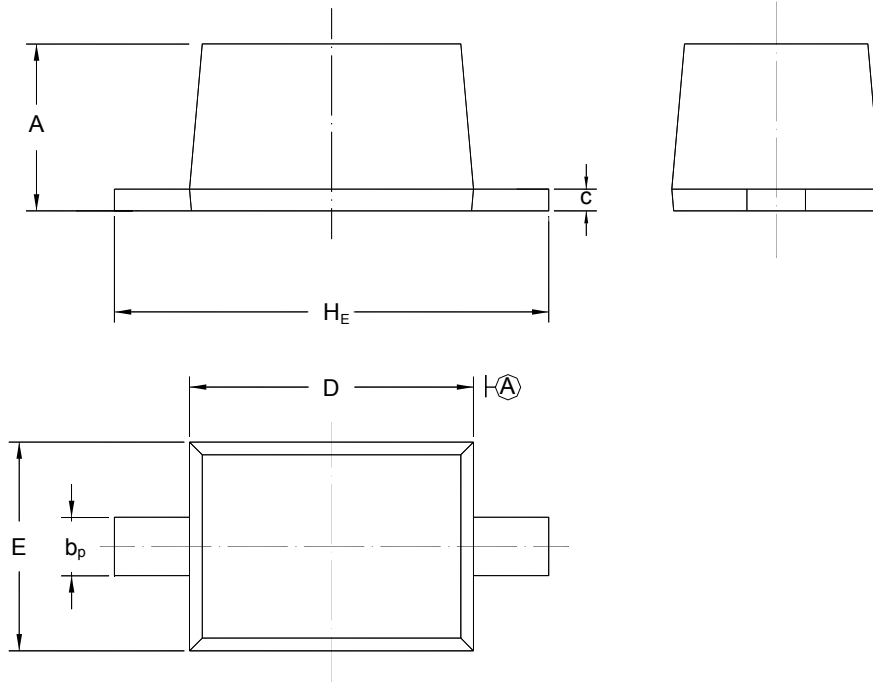

UNIT	A	b _p	C	D	E	H _E
mm	1.10 0.80	0.40 0.25	0.15 0.10	1.80 1.60	1.35 1.15	2.80 2.30

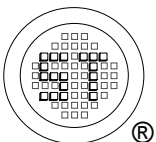

SEMTECH ELECTRONICS LTD.
Subsidiary of Sino-Tech International (BVI) Limited

