

500mA/1.5A Standalone Linear Li-Ion Battery Charge

DESCRIPTION

The BL8573 is a single cell, fully integrated constant current (CC)/constant voltage (CV) Li-ion battery charger. Its compact package with minimum external components requirement makes the BL8573 ideal for portable applications.

No external sense resistor or blocking diode is necessary for the BL8573. Build-in thermal feedback mechanism regulates the charge current to control the die temperature during high power operation or at elevated ambient temperature.

The BL8573 has a pre-charge function for trickle charging deeply discharged batteries. The fast charge current can be programmed by an external resistor. CV regulation mode is automatically enabled once the battery's charging curve reaches the constant voltage portion. The output current then decays and is finally terminated once the charge current drops to 1/10th of the programmed value. The BL8573 keeps monitoring the battery voltage and enables a new charge cycle once the voltage drops by 150mV below the CV value.

Power supply state is constantly monitored and the battery drain current is reduced to minimum value automatically when the BL8573 senses a lack of input power. In its shutdown mode, the BL8573 can reduce the supply current to less than 25 μ A. A status pin outputs a logic HIGH/LOW to indicate the charging status and the presence of power supply.

Other features include charge current monitor, under-voltage lockout.

FEATURES

- Standalone Capability with no Requirement of External MOSFET, Sense Resistor or Blocking Diode.
- Complete Linear Charger in Compact Package for Single Cell Lithium-Ion Batteries
- Programmable Pre-charge, Fast Charge and Termination Current.
- Constant-Current/Constant-Voltage Operation with Thermal Regulation to Maximize Charge Rate Without Risk of Overheating
- Charges Single Cell Li-Ion Batteries Directly from USB Port
- Preset 4.2V/4.35V Charge Voltage with $\pm 1\%$ Accuracy
- Automatic Recharge
- Charge Status Output Pin
- C/10 Charge Termination
- 25 μ A Supply Current in Shutdown
- 2.9V Trickle Charge Threshold
- Soft-Start Limits Inrush Current
- Available in SOT-23-6 and ESOP8 Package

APPLICATIONS

- Cellular Telephones, PDAs, MP3 Players
- Charging Docks and Cradles
- Bluetooths Applications

TYPICAL APPLICATION

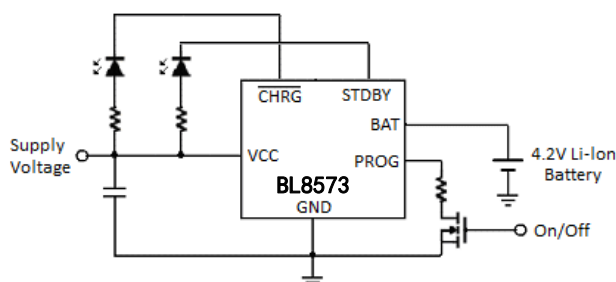

ORDERING INFORMATION

BL8573 1 2 3 4

Code	Description
1	Temperature&RoHS: C:-40~85°C ,Pb Free RoHS Std.
2	Package type: B6:SOT-23-6 S8: ESOP-8
3	Packing type: TR:Tape&Reel (Standard)
4	Output voltage: 435=4,35V Blank(default)=4.2V

PIN CONFIGURATION

Product Classification		BL8573CB6TR
Marking		
B1YW	B1:Product Code	
	YW:Data Code	
Product Classification		BL8573CB6TR435
Marking		
B1YW	B1:Product Code	
	YW:Data Code	
Product Classification		BL8573CS8TR
LLHYW	LL: Lot No.	
	H: Fab code	
	YW: Date code	

Note: Y: The Year of manufacturing, "1" stands for year 2011, "2" stands for year 2012, and "8" stands for year 2018.

W: The week of manufacturing. "A" stands for week 1, "Z" stands for week 26, "A" stands for week 27, "Z" stands for week 52.

ABSOLUTE MAXIMUM RATING

VCC	-0.3V to 6.5V
PROG	- 0.3V to VCC + 0.3V
BAT	-0.3V to 5V
CHRG	-0.3V to 6.5V
STDBY	-0.3V to 6.5V
BAT Short-Circuit Duration	Continuous
PROG Pin Current	2mA
Maximum Junction Temperature	125°C
Operating Ambient Temperature Range	-40°C to 85°C
Storage Temperature Range	-40°C to 125°C
Lead Temperature (Soldering, 10 sec)	260°C

Note:

Exceed these limits to damage to the device.

Exposure to absolute maximum rating conditions may affect device reliability.

BLOCK DIGRAM

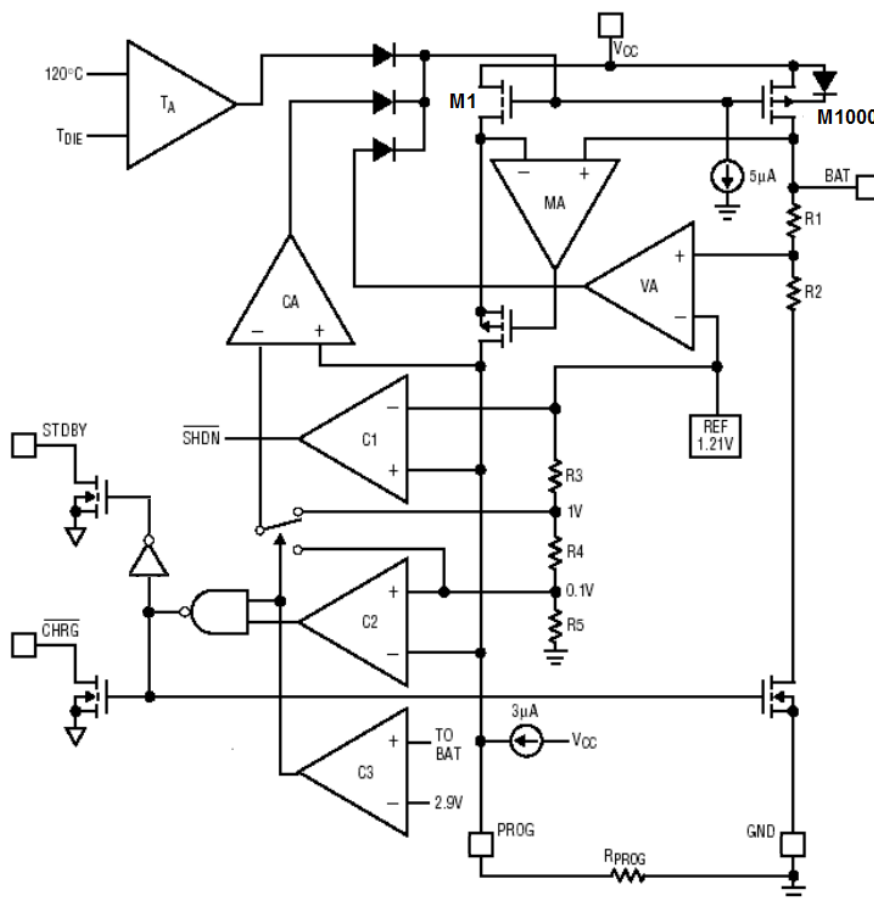

PIN DESCRIPTION

CHRG: Open-Drain Charge Status Output. The **CHRG** pin outputs low when the battery is charging.

STDBY: Open-Drain Charge Status Output. The **STDBY** pin outputs low when the battery is full.

GND: Ground.

BAT: Charge Current Output. This pin provides charge current to the battery and regulates the final float voltage to 4.2V/4.35V which is set by an internal precision resistor divider.

VCC: Positive Input Supply. Needs to be bypassed with at least a 1µF capacitor. When input voltage drops to within 30mV of the **BAT** pin voltage, the BL8573 switches to shutdown mode.

PROG: Program, Monitor the charge current and Shutdown. This pin set to 1V in constant-current mode. The charge current is programmed by connecting a 1% resistor, **RPROG**, to **GND** pin. The charge current can be calculated using the following formula:

$$I_{BAT} = (V_{PROG} / R_{PROG}) \cdot 1000$$

The **PROG** pin can also be used to switch the charger to shutdown mode by disconnecting the program resistor from ground. This results in a 3µA current to pull the **PROG** pin to a high level shutdown threshold voltage, thus stop the charging and reduce the supply current to 25µA. This pin is also clamped to approximately 2.4V. A higher voltage beyond this value will draw currents as high as 1.5mA. Device normal operation can be resumed by reconnecting the **RPROG** resistor to ground.

ELECTRICAL CHARACTERISTICS

VCC=5V, Ta=25°C, RPROG=10K, unless otherwise noted.

SYMBOL	PARAMETER	CONDITIONS	MIN	TYP	MAX	UNITS
VCC	Input Supply Voltage		4.25		6.0	V
ICC	Input Supply Current	Charge Mode (Note 2)		300	2000	μA
		Standby Mode (Charge Terminated)		200	500	μA
		Shutdown Mode (R _{PROG} Not Connected, VCC<V _{BAT} , or VCC<V _{ULO})		25	50	μA
V _{FLOAT}	Regulated Output (Float) Voltage	I _{BAT} = 40mA	4.158	4.2	4.242	V
			4.3065	4.35	4.3935	V
I _{BAT}	BAT Pin Current	Current Mode	93	100	107	mA
		R _{PROG} = 2K, Current Mode	465	500	535	mA
		Standby Mode, V _{BAT} = 4.2V	0	-2.5	-6	μA
		Shutdown Mode (R _{PROG} Not Connected)		1	5	μA
		Sleep Mode, VCC = 0V		1	5	μA
I _{TRIKL}	Trickle Charge Current	V _{BAT} < V _{TRIKL} , R _{PROG} = 2K	20	45	70	mA
V _{TRIKL}	Trickle Charge Threshold Voltage	V _{BAT} Rising	2.8	2.9	3	V
V _{TRHYS}	Trickle Charge Hysteresis Voltage		60	80	110	mV
V _{UV}	VCC Undervoltage Lockout Threshold	From VCC Low to High	2.7	2.8	2.92	V
V _{UVHYS}	VCC Undervoltage Lockout Hysteresis		150	200	300	mV
V _{MSD}	Manual Shutdown Threshold Voltage	PROG Pin Rising	1.15	1.21	1.30	V
		PROG Pin Falling	0.9	1	1.1	V
V _{ASD}	VCC-V _{BAT} Lockout Threshold Voltage	VCC from Low to High	70	100	140	mV
		VCC from High to Low	5	30	50	mV
I _{TERM}	C/10 Termination Current Threshold	Note 3	0.085	0.1	0.115	mA
V _{PROG}	PROG Pin Voltage	Current Mode, V _{BAT} =4V	0.93	1	1.07	V
V _{CHRG}	CHRG Pin Output Low Voltage	I _{CHRG} = 5mA		0.35	0.6	V
V _{RECHRG}	Recharge BAT Threshold Voltage	V _{FLOAT} - V _{RECHRG}	100	150	200	mV
T _{LIM}	Junction Temperature in Constant Temperature Mode			120		°C
R _{ON}	Power FET "ON" Resistance (Between VCC and BAT)			0.25		Ω
t _{SS}	Soft-Start Time	I _{BAT} = 0 to I _{BAT} = 1000V/R _{PROG}		100		μs
t _{RECHARGE}	Recharge Comparator Filter Time	V _{BAT} High to Low	0.5	5	20	ms
t _{TERM}	Termination Comparator Filter Time	I _{BAT} Falling Below I _{CHG} /10	400	1000	2500	μs
I _{PROG}	PROG Pin Pull-Up Current			3		μA

Note2 : Supply current includes PROG pin current (approximately 100μA) but does not include any current delivered to the battery through the BAT pin (approximately 100mA).

Note3 : I_{TERM} is expressed as a fraction of measured full charge current with indicated PROG resistor.

TYPICAL PERFORMANCE CHARACTERISTICS

(Vcc=5V, Ta=25°C, unless otherwise noted.)

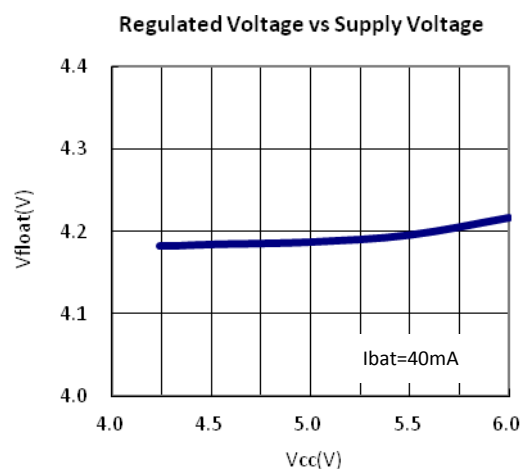
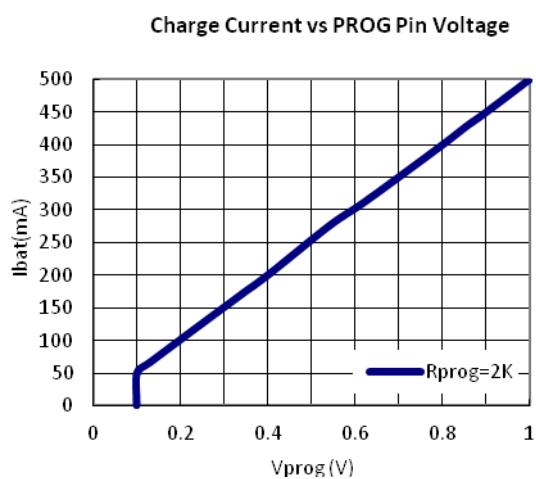
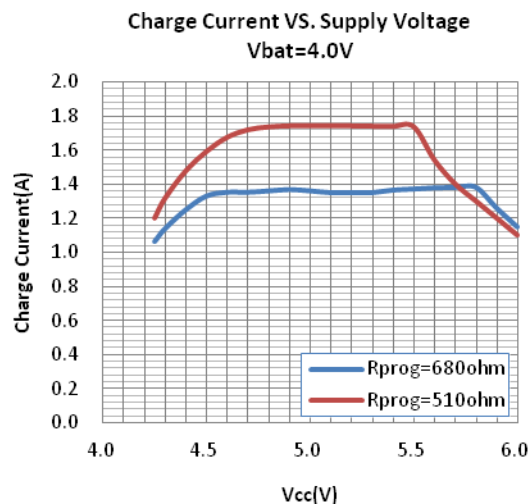
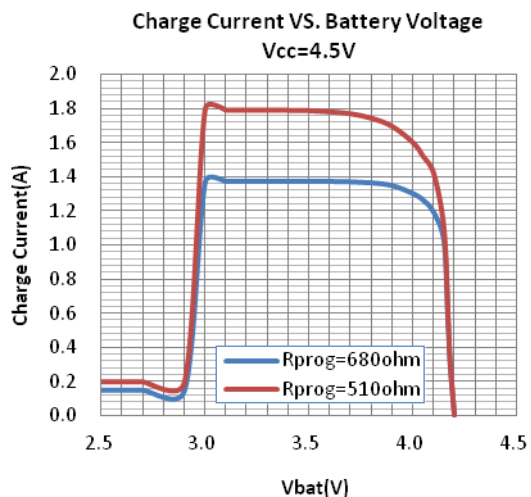

PROG Pin Current vs PROG Pin Voltage
(Pul-Up Current)

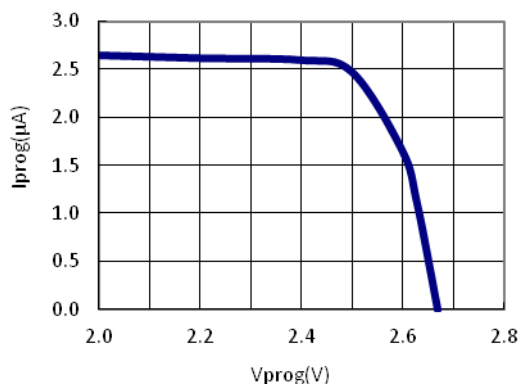

PROG Pin Current vs PROG Pin Voltage
(Clamp Current)

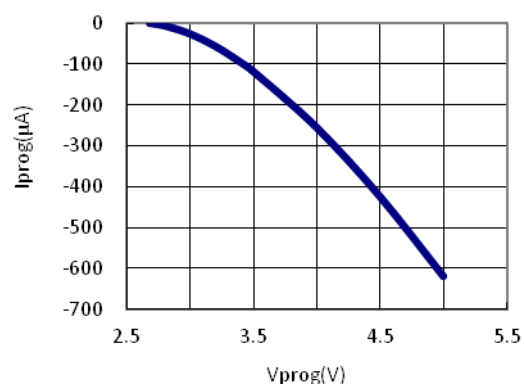

TYPICAL PERFORMANCE CHARACTERISTICS (CONTINUES)

(V_{cc}=5V, T_a=25°C, unless otherwise noted.)

CHRG Pin Current vs CHRG Pin Voltage

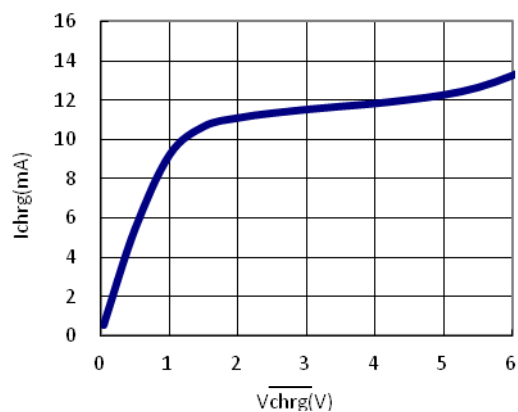

Trickle Charge Voltage vs Temperature

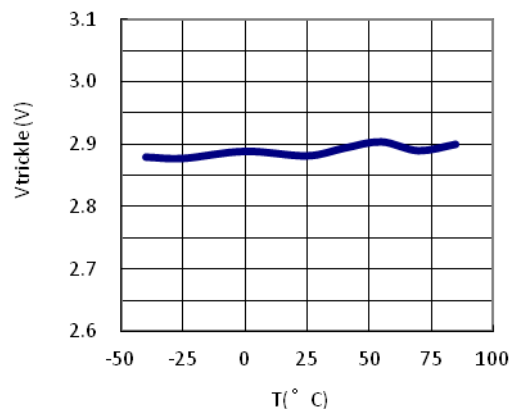

Regulated Voltage vs Temperature

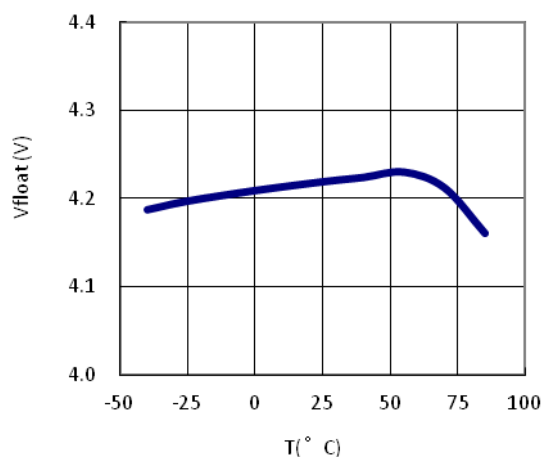

PROG Pin Voltage vs Temperature

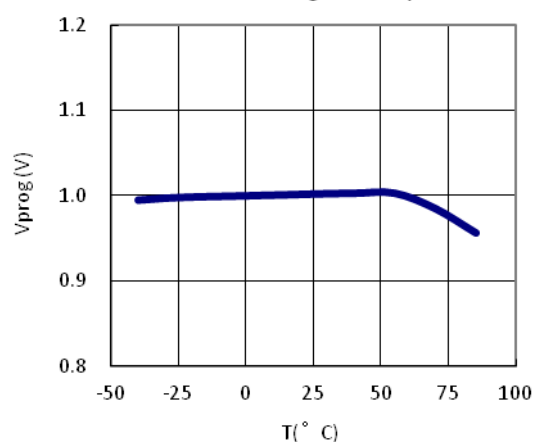

Recharge Voltage vs Temperature

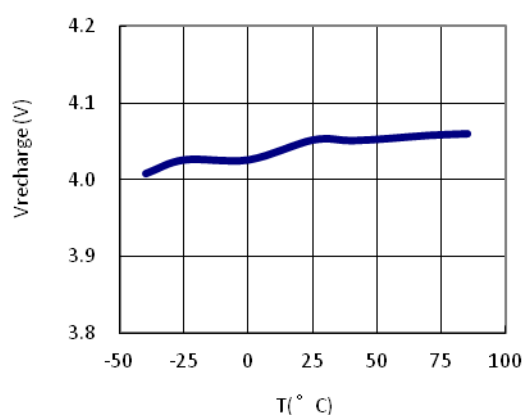

IC Temperature vs Battery Voltage

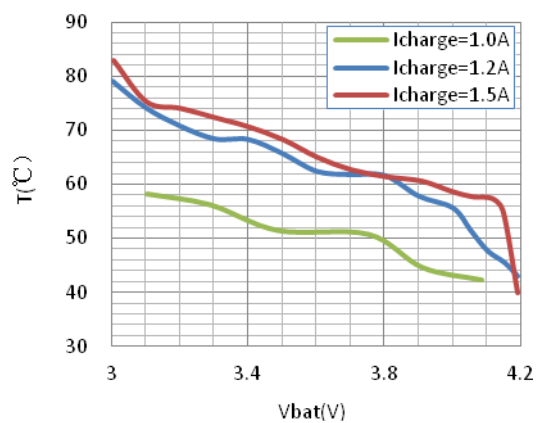

DETAILED DESCRIPTION

The BL8573 is a single cell, fully integrated constant current(CC) /constant voltage (CV) Li-ion battery charger. It can deliver up to 1.5A of charge current with a final float voltage accuracy of $\pm 1\%$. The BL8573 has a build-in thermal regulation circuitry that ensures its safe operation. No blocking diode or external current sense resistor is required; hence reduce the external components for a basic charger circuit to two. The BL8573 is also capable of operating from a USB power source.

NORMAL CHARGE CYCLE

The BL8573 initiates a charge cycle once the voltage at the VCC pin rises above the UVLO threshold level. A $\pm 1\%$ precision resistor needs to be connected from the PROG pin to ground. If the voltage at the BAT pin is less than 2.9V, the charger enters trickle charge mode. In this mode, the charge current is reduced to nearly 1/10 the programmed value until the battery voltage is raised to a safe level for full current charging.

The charger switches to constant-current mode as the BAT pin voltage rises above 2.9V, the charge current is thus resumed to full programmed value. When the final float voltage (4.2V/4.35V) is reached, the BL8573 enters constant-voltage mode and the charge current begins to decrease until it drops to 1/10 of the preset value and ends the charge cycle.

PROGRAMMING CHARGE CURRENT

The charge current is programmable by setting the value of a precision resistor connected from the PROG pin to ground. The charge current is 1000 times of the current out of the PROG pin. The program resistor and the charge current are calculated using the following equations:

$$R_{PROG} = \frac{1000V}{I_{CHG}}$$

The charge current out of the BAT pin can be determined at any time by monitoring the PROG pin voltage using the following equation:

$$I_{BAT} = \frac{V_{PROG}}{R_{PROG}} \cdot 1000$$

BL8573 has a self-temperature-limiting (STL) function, the chip starts to limit its charge current by reducing VPROG gradually after silicon temperature rises above 70°C. Say if the difference of junction and ambient

temperature is 45°C at certain power rating, BL8573 would have the same charge current and junction temperature as chips without STL function at room temperature. As the ambient temperature rises up to 55°C, a chip without STL would have 100°C of junction temperature, while BL8573 would reduce its charge current and hence the junction temperature would be much lower. The STL function helps to improve system reliability.

CHARGE TERMINATION

The BL8573 keeps monitoring the PROG pin during the charging process. It terminates the charge cycle when the charge current falls to 1/10th the programmed value after the final float voltage is reached. When the PROG pin voltage falls below 100mV for longer than tTERM (typically 1ms), charging is terminated. The charge current is latched off and the BL8573 enters standby mode, where the input supply current drops to 200µA. (Note: C/10 termination is disabled in trickle charging and thermal limiting modes).

During charging, the transient response of the circuit can cause the PROG pin to fall below 100mV temporarily before the battery is fully charged, thus can cause a premature termination of the charge cycle. A 1ms filter time (tTERM) on the termination comparator can prevent this from happening. Once the average charge current drops below 1/10th the

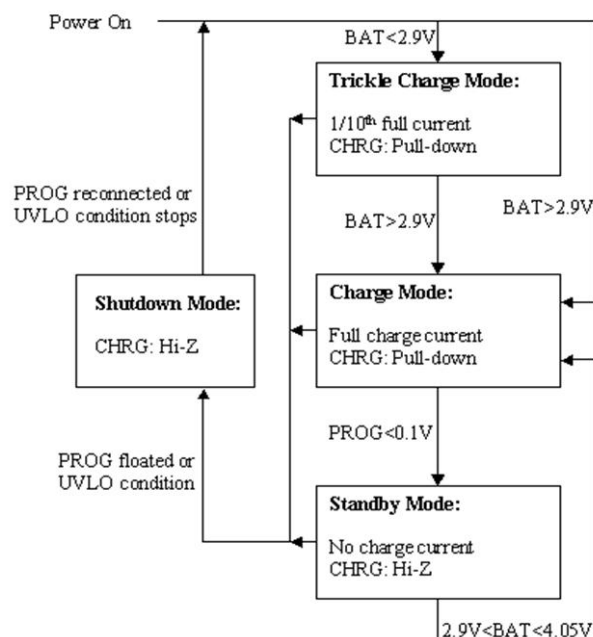

Figure1. Charge Cycle Diagram

programmed value, the BL8573 terminates the charge cycle and ceases to provide any current through the BAT pin. In this state, all loads on the BAT pin must be supplied by the battery.

The BL8573 constantly monitors the BAT pin voltage in standby mode and resume another charge cycle if this voltage drops below the recharge threshold (VRECHRG). User can also manually restart a charge cycle in standby mode either by removing and then reapplied the input voltage or restart the charger using the PROG pin. A diagram of typical charge cycle is shown in Figure 1.

CHARGE STATUS INDICATOR ($\overline{\text{CHRG}}$)

There are two different states of the charge status output, namely pull-down and high impedance. The pull-down state indicates that the BL8573 is in a charge cycle. When the charge cycle has terminated, the pin state is then determined by undervoltage lockout conditions. If the difference between VCC and BAT pin voltage is less than 100mV or insufficient voltage is applied to the VCC pin, High impedance appears on the charge status pin.

THERMAL LIMITING

Build-in feedback circuitry mechanism can reduce the value of the programmed charge current once the die temperature tends to rise above 120°C, hence prevents the temperature from further increase and ensure device safe operation.

APPLICATIONS INFORMATION

STABILITY CONSIDERATIONS

When a battery is connected to the output, the constant-voltage mode feedback is always stable. However, in the case of absence of battery, an output capacitor is recommended to reduce ripple voltage. In the case of high value capacitance or low ESR ceramic capacitors, a small value series resistor ($\sim 1\Omega$) is recommended. No series resistor is needed if tantalum capacitors are used.

In constant-current mode, the PROG pin is in the feedback loop, thus its impedance affects the stability. The maximum allowed value of the program resistor is 20K, and additional capacitance reduces this value.

UNDervoltage LOCKOUT (UVLO)

Build-in undervoltage lockout circuit monitors the input voltage and keeps the charger in shutdown mode until VCC rises above the undervoltage lockout threshold. The UVLO circuit has a built-in hysteresis of 200mV. Furthermore, to protect against reverse current in the power MOSFET, the UVLO circuit keeps the charger in shutdown mode if VCC falls to within 30mV of the battery voltage. If the UVLO comparator is tripped, the charger will not come out of shutdown mode until VCC rises 100mV above the battery voltage.

MANUAL SHUTDOWN

Floating the PROG pin by removing the resistor from PROG pin to ground can put the device in shutdown mode. The battery drain current is thus reduced to less than 5 μ A and the supply current to less than 50 μ A. Reconnecting the resistor back will restart a new charge cycle.

The $\overline{\text{CHRG}}$ pin is in a high impedance state if the BL8573 is in undervoltage lockout mode.

AUTOMATIC RECHARGE

After the termination of the charge cycle, the BL8573 constantly monitors the BAT pin voltage and starts a new charge cycle when the battery voltage falls below 4.05V, keeping the battery at fully charged condition. $\overline{\text{CHRG}}$ output enters a pull-down state during recharge cycles.

The pole frequency at the PROG pin needs to be kept above 100kHz to maintain device stability. Therefore, the maximum resistance value can be calculated from the following equation, C_{PROG} is the capacitance loaded to the PROG pin

$$R_{PROG} \leq \frac{1}{2\pi \cdot 10^5 \cdot C_{PROG}}$$

Average rather than instantaneous charge current is more of a concern. A simple low pass filter can be used on the PROG pin to measure the average battery current as shown in Figure 2. A 10K resistor has been added between the PROG pin and the filter capacitor to ensure stability.

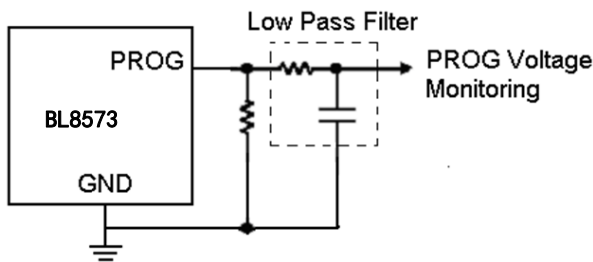

Figure2. Isolating Capacitive Load on PROG Pin and Filtering

POWER DISSIPATION

The power dissipated in the IC causes the rise of die temperature. Most of the power dissipation is caused by the internal power MOSFET, and can be calculated by the following equation:

$$P_D = (V_{CC} - V_{BAT}) \cdot I_{BAT}$$

Where PD is the power dissipated, VCC is the input supply voltage, VBAT is the battery voltage and IBAT is the charge current. The approximate ambient temperature at which the thermal feedback begins to protect the IC is:

$$T_A = 120^\circ\text{C} - P_D \theta_{JA}$$

$$T_A = 120^\circ\text{C} - (V_{CC} - V_{BAT}) \cdot I_{BAT} \cdot \theta_{JA}$$

Example: An BL8573 operating from a 5V USB supply is programmed to supply 400mA full-scale current to a discharged Li-Ion battery with a voltage of 3.75V.

Assuming θ_{JA} is $150^\circ\text{C}/\text{W}$ (see Board Layout Considerations), the ambient temperature at which the BL8573 will begin to reduce the charge current is approximately:

$$T_A = 120^\circ\text{C} - (5\text{V} - 3.75\text{V}) \cdot (400\text{mA}) \cdot 150^\circ\text{C}/\text{W}$$

$$T_A = 120^\circ\text{C} - 0.5\text{W} \cdot 150^\circ\text{C}/\text{W} = 120^\circ\text{C} - 75^\circ\text{C}$$

$$T_A = 45^\circ\text{C}$$

The BL8573 can be used above 45°C ambient, but the charge current will be reduced from 400mA. The approximate current at a given ambient temperature can be approximated by:

$$I_{BAT} = \frac{120^\circ\text{C} - T_A}{(V_{CC} - V_{BAT}) \cdot \theta_{JA}}$$

Using the previous example with an ambient temperature of 60°C , the charge current will be reduced to approximately:

$$I_{BAT} = \frac{120^\circ\text{C} - 60^\circ\text{C}}{(5\text{V} - 3.75\text{V}) \cdot 150^\circ\text{C}/\text{W}} = \frac{60^\circ\text{C}}{187.5^\circ\text{C}/\text{A}}$$

$$I_{BAT} = 320\text{mA}$$

Moreover, when thermal feedback reduces the charge current, the voltage at the PROG pin is also reduced proportionally as discussed in the operation section.

It is important to remember that BL8573 applications do not need to be designed for worst-case thermal conditions since the IC will automatically reduce power dissipation when the junction temperature reaches approximately 120°C .

THERMAL CONSIDERATIONS

Due to its compact size, it is of great importance to use a good thermal PC board. Good thermal conduction increases maximum allowed charge current value.

The thermal path for the heat generated by the IC is from the die to the copper lead frame, through the package leads, (especially the ground lead) to the PC board copper. The PC board copper is the heat sink. The footprint copper pads should be as wide as possible and expand out to larger copper areas to spread and dissipate the heat to the surrounding ambient. Feed through vias to inner or backside copper layers are also useful in improving the overall thermal performance of the charger. Other heat sources on the board, not related to the charger, must also be considered when designing a PC board layout because they will affect overall temperature rise and the maximum charge current.

INCREASING THERMAL REGULATION CURRENT

Reducing the voltage drop across the internal MOSFET can significantly decrease the power dissipation in the IC. Minimized power dissipation results in reduced die temperature rise and hence equivalent increased charge current in thermal regulation. One way is to bypass some of the current through an external component, such as a resistor or diode.

Example: An BL8573 operating from a 5V wall adapter is programmed to supply 600mA full-scale current to a discharged Li-Ion battery with a voltage of 3.75V.

Assuming θ_{JA} is $125^\circ\text{C}/\text{W}$, the approximate charge current at an ambient temperature of 25°C is:

$$I_{BAT} = \frac{120^{\circ}C - 25^{\circ}C}{(5V - 3.75V) \cdot 125^{\circ}C/W} = 608mA$$

By dropping voltage across a resistor in series with a 5V wall adapter (shown in Figure 3), the on-chip power dissipation can be decreased, thus increasing the thermally regulated charge current

$$I_{BAT} = \frac{120^{\circ}C - 25^{\circ}C}{(V_S - I_{BAT} R_{CC} - V_{BAT}) \cdot \theta_{JA}}$$

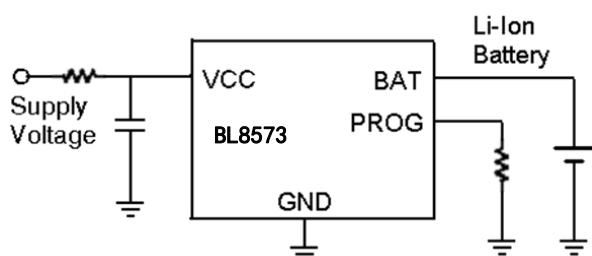

Figure3. A Circuit to Maximize Thermal Mode Charge Current

VCC BYPASS CAPACITOR

Due to their self-resonant and high Q characteristics, some types of ceramic capacitors can cause high voltage transients under some start-up conditions (i.e connecting the charger input to a live power source). Adding a small value resistor in series with the ceramic capacitor can minimize start-up voltage transients

CHARGE CURRENT SOFT-START

To avoid the start-up transients, a soft-start circuit is included to ramp the charge current from zero to programmed value over a period of time. This has the effect of minimizing the transient current load on the power supply during start-up.

PACKAGE LINE

Package	SOT-23-6	Devices per reel	3000Pcs	Unit	mm
Package specification:					

Package	ESOP-8	Devices per reel	2500	Unit	mm																																																																																																								
Package specification:																																																																																																													
<p>COMMON DIMENSIONS (UNITS OF MEASURE=MILLIMETER)</p> <table border="1"> <thead> <tr> <th>SYMBOL</th> <th>MIN</th> <th>NOM</th> <th>MAX</th> </tr> </thead> <tbody> <tr> <td>A</td> <td>1.35</td> <td>1.55</td> <td>1.75</td> </tr> <tr> <td>A1</td> <td>0</td> <td>0.10</td> <td>0.15</td> </tr> <tr> <td>A2</td> <td>1.25</td> <td>1.40</td> <td>1.65</td> </tr> <tr> <td>A3</td> <td>0.50</td> <td>0.60</td> <td>0.70</td> </tr> <tr> <td>b</td> <td>0.38</td> <td>-</td> <td>0.51</td> </tr> <tr> <td>b1</td> <td>0.37</td> <td>0.42</td> <td>0.47</td> </tr> <tr> <td>c</td> <td>0.17</td> <td>-</td> <td>0.25</td> </tr> <tr> <td>c1</td> <td>0.17</td> <td>0.20</td> <td>0.23</td> </tr> <tr> <td>D</td> <td>4.80</td> <td>4.90</td> <td>5.00</td> </tr> <tr> <td>D1</td> <td>3.10</td> <td>3.30</td> <td>3.50</td> </tr> <tr> <td>E</td> <td>5.90</td> <td>6.00</td> <td>6.20</td> </tr> <tr> <td>E1</td> <td>3.90</td> <td>3.90</td> <td>4.00</td> </tr> <tr> <td>E2</td> <td>2.20</td> <td>2.40</td> <td>2.60</td> </tr> <tr> <td>e</td> <td>-</td> <td>1.27BSC</td> <td>-</td> </tr> <tr> <td>L</td> <td>0.45</td> <td>0.60</td> <td>0.80</td> </tr> <tr> <td>L1</td> <td>-</td> <td>1.04REF</td> <td>-</td> </tr> <tr> <td>L2</td> <td>-</td> <td>0.25BSC</td> <td>-</td> </tr> <tr> <td>R</td> <td>0.07</td> <td>-</td> <td>-</td> </tr> <tr> <td>R1</td> <td>0.07</td> <td>-</td> <td>-</td> </tr> <tr> <td>h</td> <td>0.30</td> <td>0.40</td> <td>0.50</td> </tr> <tr> <td>theta</td> <td>0°</td> <td>-</td> <td>8°</td> </tr> <tr> <td>theta 1</td> <td>15°</td> <td>17°</td> <td>19°</td> </tr> <tr> <td>theta 2</td> <td>11°</td> <td>13°</td> <td>15°</td> </tr> <tr> <td>theta 3</td> <td>15°</td> <td>17°</td> <td>19°</td> </tr> <tr> <td>theta 4</td> <td>11°</td> <td>13°</td> <td>15°</td> </tr> </tbody> </table>						SYMBOL	MIN	NOM	MAX	A	1.35	1.55	1.75	A1	0	0.10	0.15	A2	1.25	1.40	1.65	A3	0.50	0.60	0.70	b	0.38	-	0.51	b1	0.37	0.42	0.47	c	0.17	-	0.25	c1	0.17	0.20	0.23	D	4.80	4.90	5.00	D1	3.10	3.30	3.50	E	5.90	6.00	6.20	E1	3.90	3.90	4.00	E2	2.20	2.40	2.60	e	-	1.27BSC	-	L	0.45	0.60	0.80	L1	-	1.04REF	-	L2	-	0.25BSC	-	R	0.07	-	-	R1	0.07	-	-	h	0.30	0.40	0.50	theta	0°	-	8°	theta 1	15°	17°	19°	theta 2	11°	13°	15°	theta 3	15°	17°	19°	theta 4	11°	13°	15°
SYMBOL	MIN	NOM	MAX																																																																																																										
A	1.35	1.55	1.75																																																																																																										
A1	0	0.10	0.15																																																																																																										
A2	1.25	1.40	1.65																																																																																																										
A3	0.50	0.60	0.70																																																																																																										
b	0.38	-	0.51																																																																																																										
b1	0.37	0.42	0.47																																																																																																										
c	0.17	-	0.25																																																																																																										
c1	0.17	0.20	0.23																																																																																																										
D	4.80	4.90	5.00																																																																																																										
D1	3.10	3.30	3.50																																																																																																										
E	5.90	6.00	6.20																																																																																																										
E1	3.90	3.90	4.00																																																																																																										
E2	2.20	2.40	2.60																																																																																																										
e	-	1.27BSC	-																																																																																																										
L	0.45	0.60	0.80																																																																																																										
L1	-	1.04REF	-																																																																																																										
L2	-	0.25BSC	-																																																																																																										
R	0.07	-	-																																																																																																										
R1	0.07	-	-																																																																																																										
h	0.30	0.40	0.50																																																																																																										
theta	0°	-	8°																																																																																																										
theta 1	15°	17°	19°																																																																																																										
theta 2	11°	13°	15°																																																																																																										
theta 3	15°	17°	19°																																																																																																										
theta 4	11°	13°	15°																																																																																																										
<p>NOTES: ALL DIMENSIONS REFER TO JEDEC STANDARD MS-012 AA DO NOT INCLUDE MOLD FLASH OR PROTRUSIONS.</p>																																																																																																													