

### FEATURES

- Passive: no dc bias required
- Conversion loss: 9 dB (typical)
- Image rejection: 20 dB (typical)
- LO to RF isolation: 35 dB (typical)
- LO to IF isolation: 25 dB (typical)
- IP3: 18 dBm (typical)
- P1dB: 17 dBm (typical)
- IF pin frequency: dc – 4.5 GHz
- 12-lead, 3 mm × 3 mm SMT ceramic package

### APPLICATIONS

- Point to point radios
- Point to multipoint radios and VSAT
- Test equipment and sensors
- Military end use

### GENERAL DESCRIPTION

The HMC524ALC3B is a compact gallium arsenide (GaAs), monolithic microwave integrated circuit (MMIC), in phase quadrature (I/Q) mixer in a leadless RoHS compliant surface-mount (SMT) ceramic package. This device can be used as either an image reject mixer or a single-sideband upconverter. The mixer uses two standard, double balanced mixer cells and a 90° hybrid coupler fabricated in a GaAs, metal–semiconductor field effect transistor (MESFET) process. A low frequency quadrature hybrid produces a 100 MHz IF output.

### FUNCTIONAL BLOCK DIAGRAM

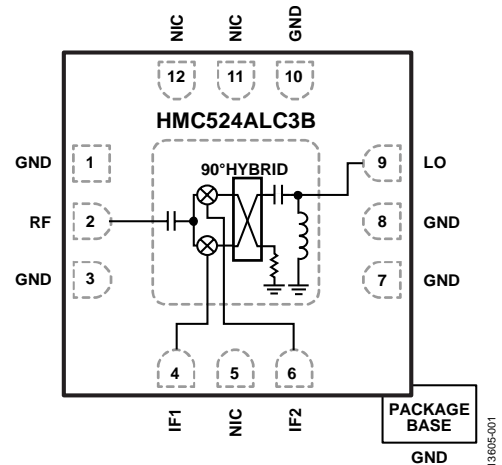

Figure 1.

This device is a much smaller alternative to hybrid style image reject mixers and single-sideband upconverter assemblies. The HMC524ALC3B eliminates the need for wire bonding, allowing use of surface-mount manufacturing techniques.

## TABLE OF CONTENTS

Features .....	1	Downconverter Performance: IF Bandwidth, Lower Sideband (High-Side LO) .....	13
Applications .....	1	Upconverter Performance: IF <sub>IN</sub> = 100 MHz, Upper Sideband (Low-Side LO) .....	14
Functional Block Diagram .....	1	Upconverter Performance: IF <sub>IN</sub> = 100 MHz, Lower Sideband (High-Side LO) .....	15
General Description .....	1	Upconverter Performance: IF <sub>IN</sub> = 2500 MHz, Upper Sideband (Low-Side LO) .....	16
Revision History .....	2	Upconverter Performance: IF <sub>IN</sub> = 2500 MHz, Lower Sideband (High-Side LO) .....	17
Specifications .....	3	Amplitude/ Phase Balance, Downconverter: IF <sub>OUT</sub> = 100 MHz .....	18
Absolute Maximum Ratings .....	4	Isolation and Return Loss .....	19
Thermal Resistance .....	4	M × N Spurious Output Performance .....	20
ESD Caution .....	4	Theory of Operation .....	21
Pin Configuration and Function Descriptions .....	5	Applications Information .....	22
Interface Schematics .....	5	Layout .....	22
Typical Performance Characteristics .....	6	Outline Dimensions .....	24
Downconverter Performance: IF <sub>OUT</sub> = 100 MHz, Upper Sideband (Low-Side LO) .....	6	Ordering Guide .....	24
Downconverter Performance: IF = 100 MHz, Lower Sideband (High-Side LO) .....	8		
Downconverter Performance: IF = 2500 MHz, Upper Sideband (Low-Side LO) .....	10		
Downconverter Performance: IF = 2500 MHz, Lower Sideband (High-Side LO) .....	11		
Downconverter Performance: IF Bandwidth, Upper Sideband (Low-Side LO) .....	12		

## REVISION HISTORY

### 5/2018—Rev. 0 to Rev. A

Changes to Table 2 .....	4
Changes to Applications Information Section .....	22
Changes to Figure 80 .....	22

### 2/2018—Revision 0: Initial Version

## SPECIFICATIONS

T<sub>A</sub> = 25°C, IF = 100 MHz, LO drive level = 17 dBm, upper sideband. All measurements performed on the evaluation printed circuit board (PCB).

Table 1.

Parameter	Test Conditions/Comments	Min	Typ	Max	Unit
FREQUENCY					
Radio Frequency (RF) Pin		22		32	GHz
Intermediate Frequency (IF) Pin		DC		4.5	GHz
Local Oscillator (LO) Pin		22		32	GHz
LO DRIVE LEVEL			17		dBm
RF PERFORMANCE					
Downconverter (IF <sub>OUT</sub> )					
Conversion Loss			9	13	dB
Image Rejection		18	20		dB
Input Third Order Intercept (IP3)		13.5	18		dBm
Input 1 dB Compression Point (P1dB)			17		dBm
Noise Figure	Taken with LO amplifier		15		dB
Amplitude Balance	Taken without external 90° hybrid		0.5		dB
Phase Balance	Taken without external 90° hybrid		5		Degrees
Upconverter					
Conversion Loss	IF <sub>IN</sub>		6		dB
Sideband Rejection			26		dB
IIP3			14		dBm
P1dB			4.5		dBm
Isolation					
LO to RF	Taken without external 90° hybrid	24	35		dB
LO to IF			25		dB
RF to IF			36		dB
Return Loss					
LO	Taken without external 90° hybrid		7		dB
RF			13		dB
IF			6		dB

## ABSOLUTE MAXIMUM RATINGS

Table 2.

Parameter	Rating
RF/IF Input Power	20 dBm
LO Input Power	25 dBm
IF Source/Sink Current	2 mA
Reflow Temperature	260°C
Maximum Junction Temperature (T <sub>J</sub> )	175°C
Lifetime at Maximum T <sub>J</sub>	>1 × 10 <sup>6</sup> hours
Continuous Power Dissipation, P <sub>DISS</sub> <sup>1</sup> (T <sub>A</sub> = 85°C, Derate 6.22 mW/°C Above 85°C)	560 mW
Operating Temperature Range	–40°C to +85°C
Storage Temperature Range	–65°C to +150°C
Lead Temperature (Soldering 60 sec)	260°C
Moisture Sensitivity Level (MSL) <sup>2</sup>	MSL3
Electrostatic Discharge (ESD) Sensitivity	
Human Body Model (HBM)	1000 V
Field Induced Charged Device Model (FICDM)	1250 V

<sup>1</sup> P<sub>DISS</sub> is a theoretical number calculated by (T<sub>J</sub> – 85°C)/θ<sub>JC</sub>.

<sup>2</sup> Based on IPC/JEDEC J-STD-20 MSL classifications.

Stresses at or above those listed under Absolute Maximum Ratings may cause permanent damage to the product. This is a stress rating only; functional operation of the product at these or any other conditions above those indicated in the operational section of this specification is not implied. Operation beyond the maximum operating conditions for extended periods may affect product reliability.

## THERMAL RESISTANCE

Thermal performance is directly linked to PCB design and operating environment. Careful attention to PCB thermal design is required.

θ<sub>JA</sub> is the natural convection junction-to-ambient thermal resistance measured in a one cubic foot sealed enclosure. θ<sub>JC</sub> is the junction to case thermal resistance.

Table 3. Thermal Resistance

Package Type <sup>1</sup>	θ <sub>JA</sub>	θ <sub>JC</sub>	Unit
E-12-4	120	161	°C/W

<sup>1</sup> Test Condition 1: JEDEC standard JESD51-2.

## ESD CAUTION



**ESD (electrostatic discharge) sensitive device.** Charged devices and circuit boards can discharge without detection. Although this product features patented or proprietary protection circuitry, damage may occur on devices subjected to high energy ESD. Therefore, proper ESD precautions should be taken to avoid performance degradation or loss of functionality.

# PIN CONFIGURATION AND FUNCTION DESCRIPTIONS

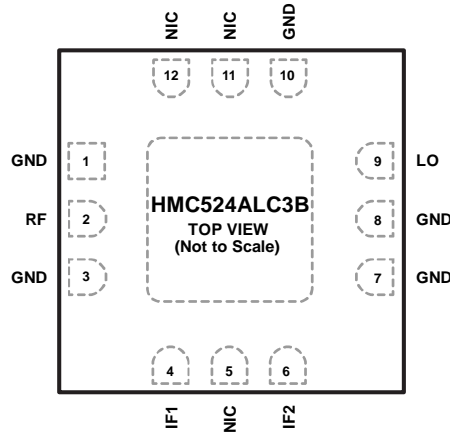

**NOTES**  
 1. NIC = NO INTERNAL CONNECTION. THESE PINS ARE NOT CONNECTED INTERNALLY.  
 2. EXPOSED PAD. THE EXPOSED PAD MUST BE CONNECTED TO THE GND PIN.

13805-002

Figure 2. Pin Configuration

Table 4. Pin Function Descriptions

Pin No.	Mnemonic	Description
1, 3, 7, 8, 10	GND	Ground Connect. These pins and package bottom must be connected to RF/dc ground.
2	RF	Radio Frequency Port. This pin is ac coupled and matched to 50 Ω.
4	IF1	First Quadrature Intermediate Frequency Output Pin. For applications not requiring operation to dc, use an off chip dc blocking capacitor. For operation to dc, these pins must not source/sink more than 2 mA of current or device nonfunction and possible device failure results.
5, 11, 12	NIC	No Internal Connection. These pins are not connected internally.
6	IF2	Second Quadrature Intermediate Frequency Output Pin. For applications not requiring operation to dc, use an off chip dc blocking capacitor. For operation to dc, these pins must not source/sink more than 2 mA of current or device nonfunction and possible device failure results.
9	LO EPAD	Local Oscillator Port. The pin is dc coupled and matched to 50 Ω. Exposed Pad. The exposed pad must be connected to the GND pin.

## INTERFACE SCHEMATICS



Figure 3. GND Interface Schematic

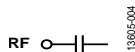

Figure 4. RF Interface Schematic

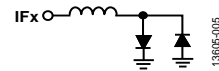

Figure 5. IFx Interface Schematic

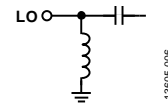

Figure 6. LO Interface Schematic

# TYPICAL PERFORMANCE CHARACTERISTICS

## DOWNCONVERTER PERFORMANCE: $IF_{OUT} = 100\text{ MHz}$ , UPPER SIDEBAND (LOW-SIDE LO)

Data taken as an image reject mixer with external  $90^\circ$  hybrid at the IF ports, LO = 17 dBm, unless otherwise noted.

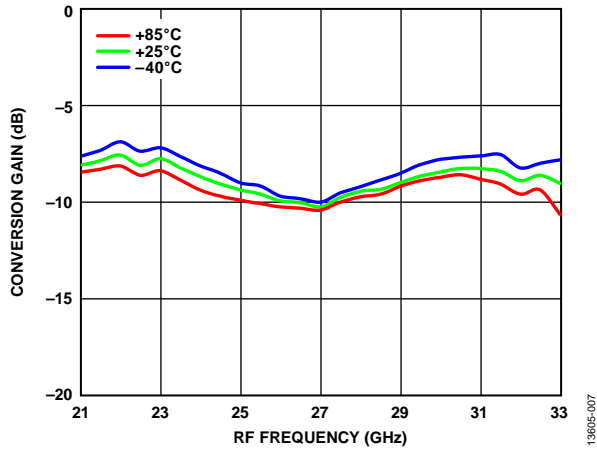

Figure 7. Conversion Gain vs. RF Frequency at Various Temperatures

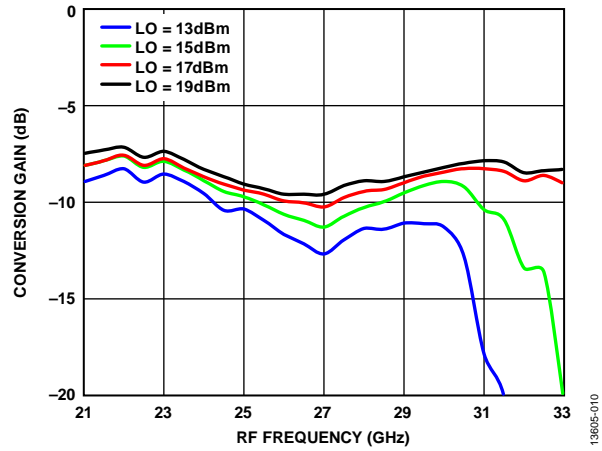

Figure 10. Conversion Gain vs. RF Frequency at Various LO Powers,  $T_A = 25^\circ\text{C}$

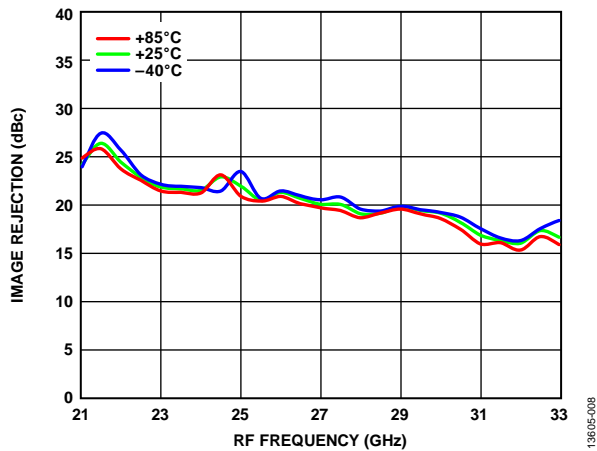

Figure 8. Image Rejection vs. RF Frequency at Various Temperatures

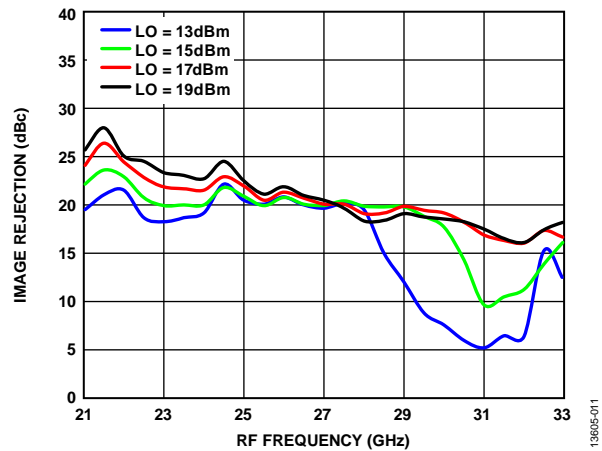

Figure 11. Image Rejection vs. RF Frequency at Various LO Powers,  $T_A = 25^\circ\text{C}$

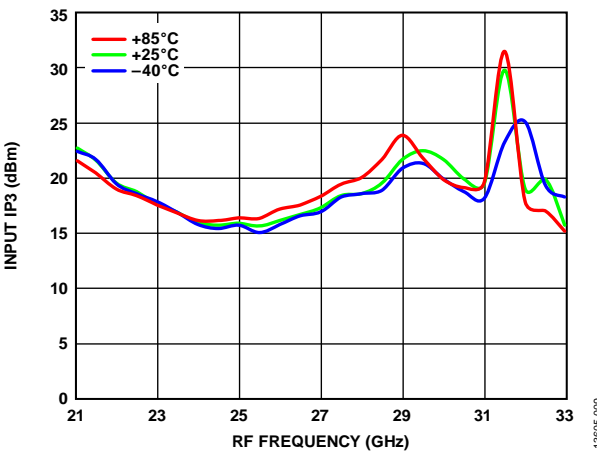

Figure 9. Input IP3 vs. RF Frequency at Various Temperatures

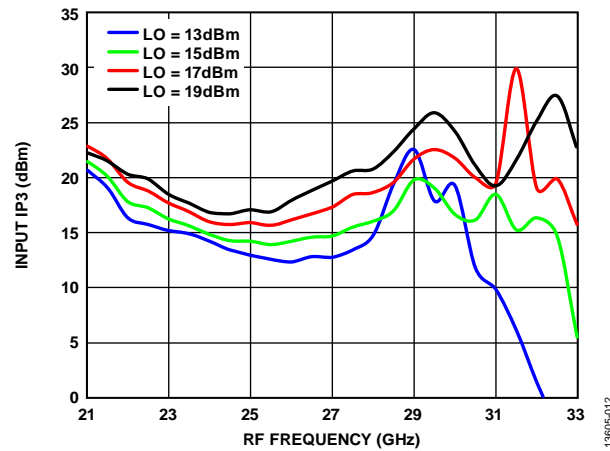

Figure 12. Input IP3 vs. RF Frequency at Various LO Powers,  $T_A = 25^\circ\text{C}$

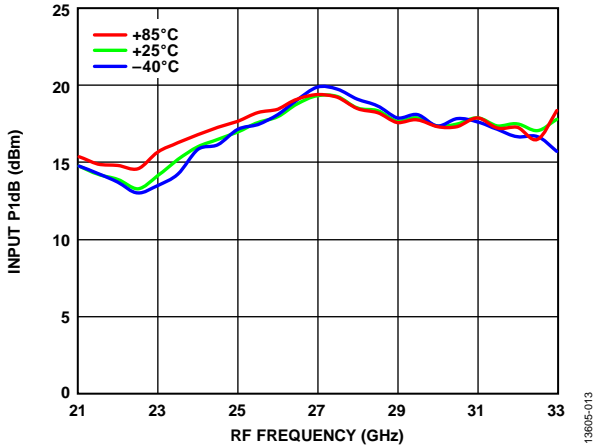

Figure 13. Input P1dB vs. RF Frequency at Various Temperatures

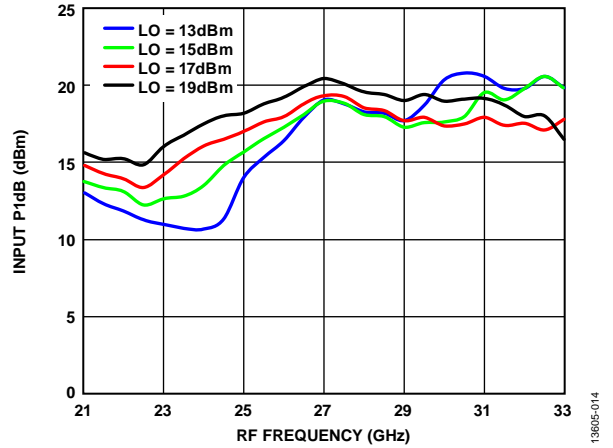

Figure 15. Input P1dB vs. RF Frequency at Various LO Powers,  $T_A = 25^\circ\text{C}$

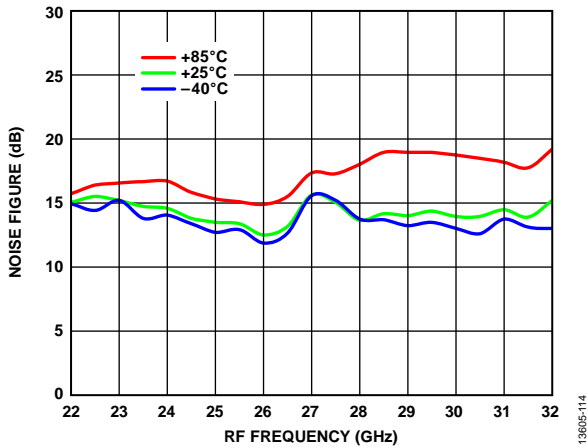

Figure 14. Noise Figure vs. RF Frequency at Various Temperatures

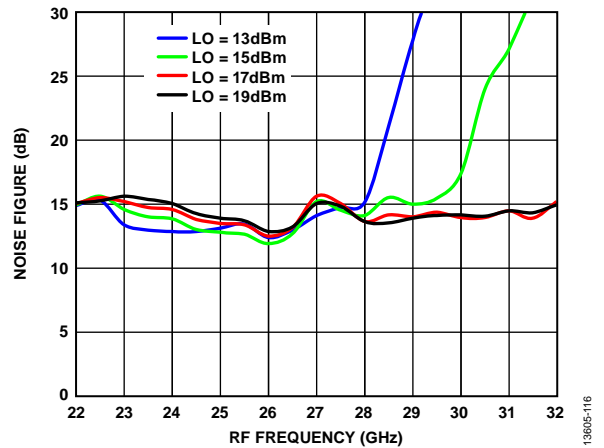

Figure 16. Noise Figure vs. RF Frequency at Various LO Powers,  $T_A = 25^\circ\text{C}$

**DOWNCONVERTER PERFORMANCE: IF = 100 MHz, LOWER SIDEBAND (HIGH-SIDE LO)**

Data taken as an image reject mixer with external 90° hybrid at the IF ports, LO = 17 dBm, unless otherwise noted.

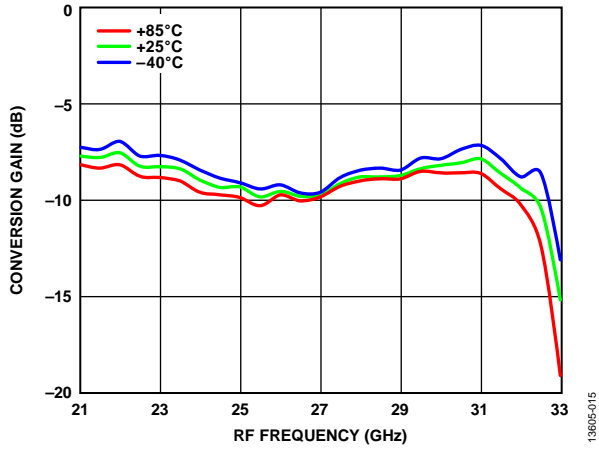

Figure 17. Conversion Gain vs. RF Frequency at Various Temperatures

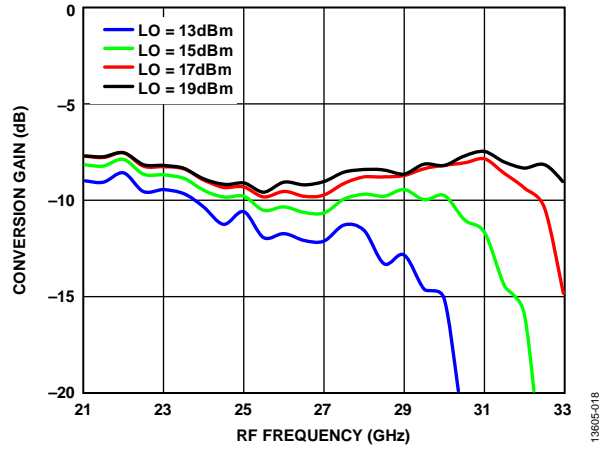

Figure 20. Conversion Gain vs. RF Frequency at Various LO Powers,  $T_A = 25^\circ\text{C}$

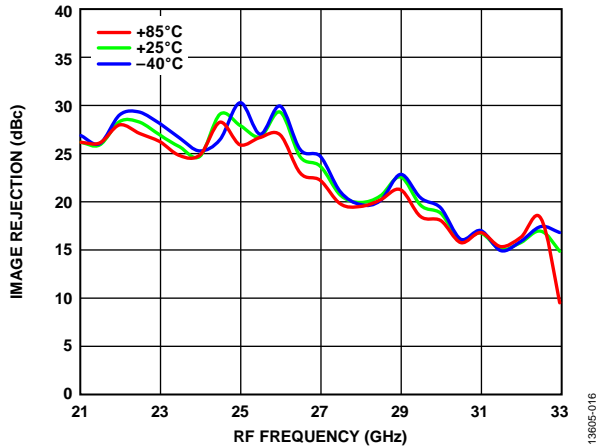

Figure 18. Image Rejection vs. RF Frequency at Various Temperatures

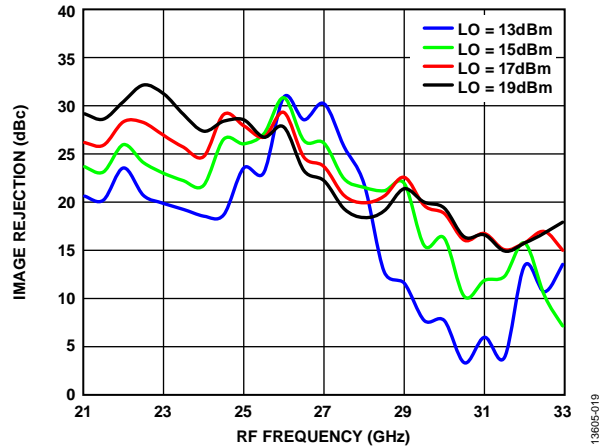

Figure 21. Image Rejection vs. RF Frequency at Various LO Powers,  $T_A = 25^\circ\text{C}$

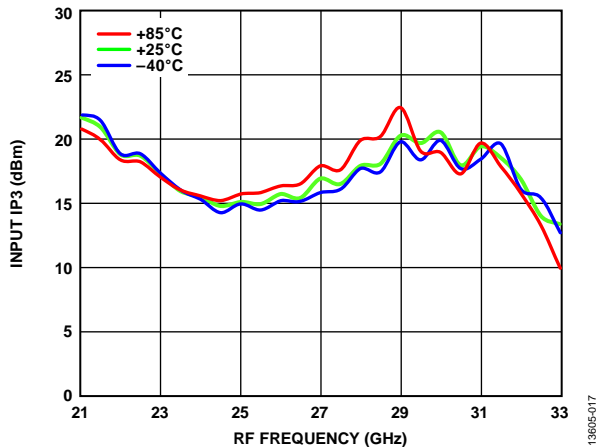

Figure 19. Input IP3 vs. RF Frequency at Various Temperatures

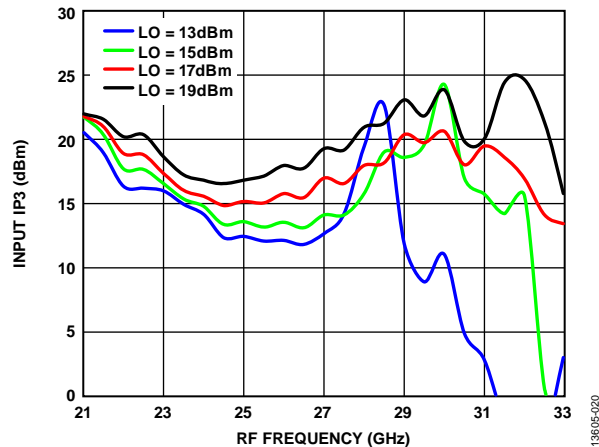

Figure 22. Input IP3 vs. RF Frequency at Various LO Powers,  $T_A = 25^\circ\text{C}$



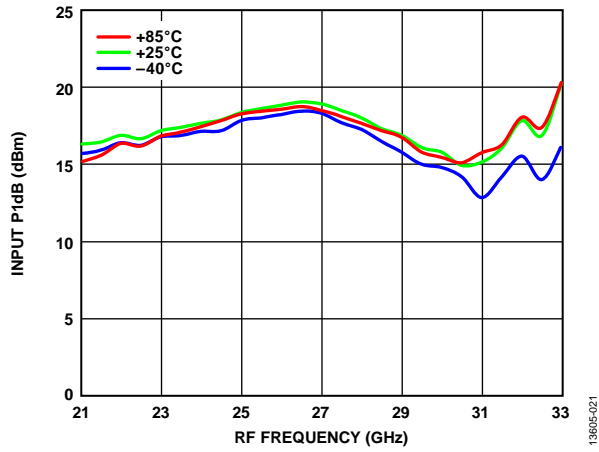

Figure 23. Input P1dB vs. RF Frequency at Various Temperatures

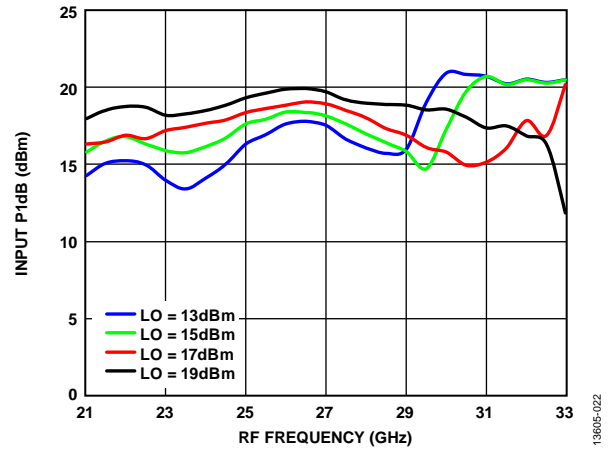

Figure 24 Input P1dB vs. RF Frequency at Various LO Powers, TA = 25°C

**DOWNCONVERTER PERFORMANCE: IF = 2500 MHz, UPPER SIDEBAND (LOW-SIDE LO)**

Data taken as an image reject mixer with external 90° hybrid at the IF ports, LO = 17 dBm, unless otherwise noted.

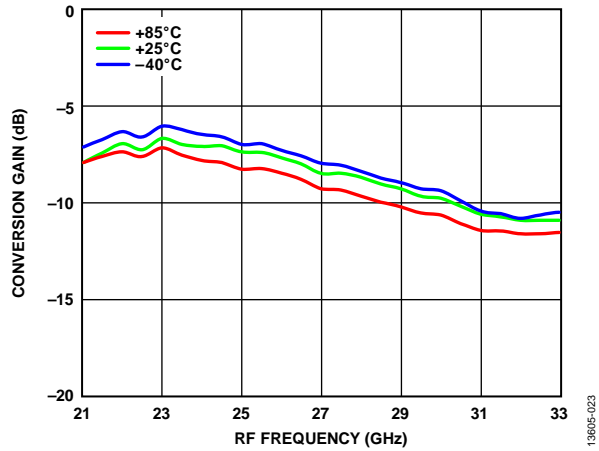

Figure 25. Conversion Gain vs. RF Frequency at Various Temperatures

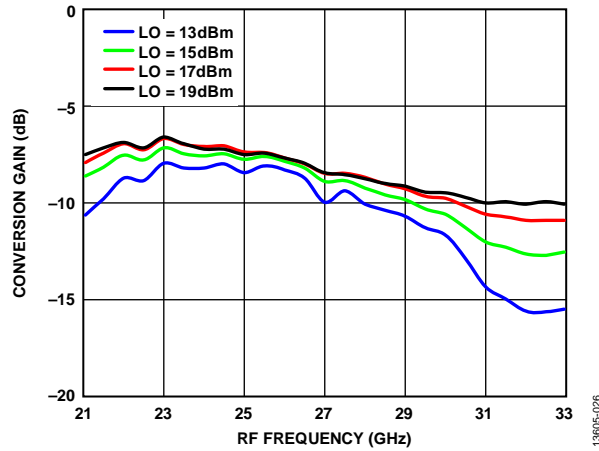

Figure 28. Conversion Gain vs. RF Frequency at Various LO Powers,  $T_A = 25^\circ\text{C}$

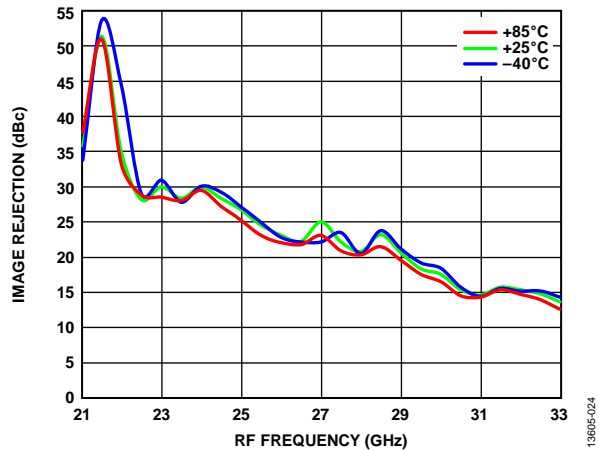

Figure 26. Image Rejection vs. RF Frequency at Various Temperatures

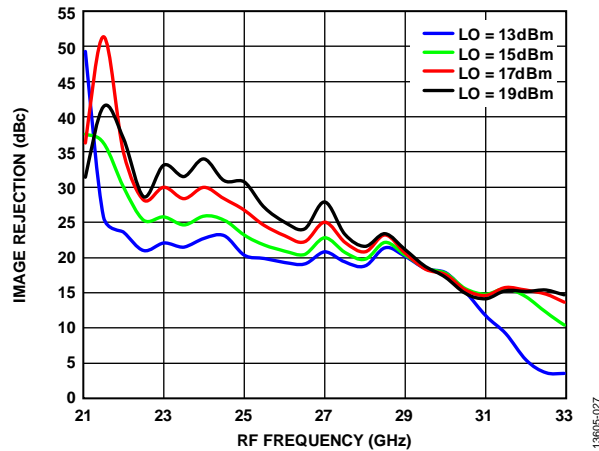

Figure 29. Image Rejection vs. RF Frequency at Various LO Powers,  $T_A = 25^\circ\text{C}$

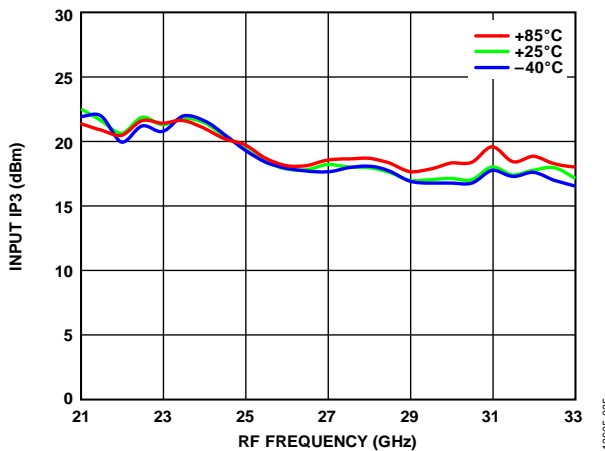

Figure 27. Input IP3 vs. RF Frequency at Various Temperatures

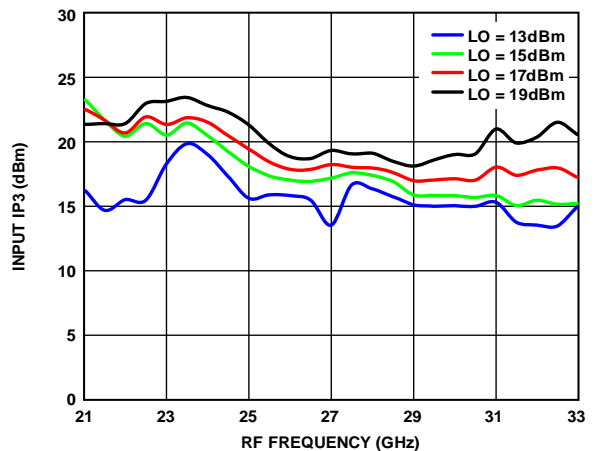

Figure 30. Input IP3 vs. RF Frequency at Various LO Powers,  $T_A = 25^\circ\text{C}$

**DOWNCONVERTER PERFORMANCE: IF = 2500 MHz, LOWER SIDEBAND (HIGH-SIDE LO)**

Data taken as an image reject mixer with external 90° hybrid at the IF ports, LO = 17 dBm, unless otherwise noted.

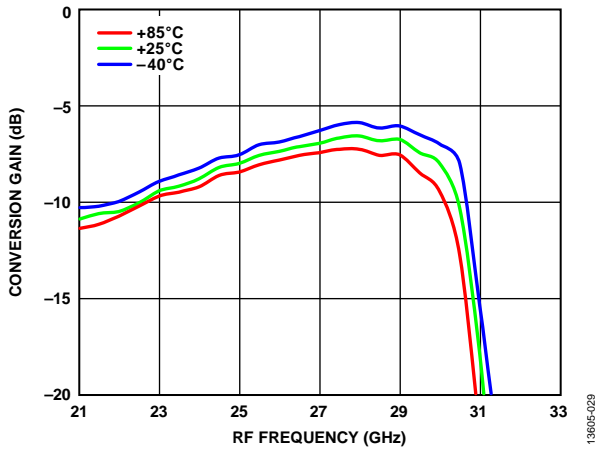

Figure 31. Conversion Gain vs. RF Frequency at Various Temperatures

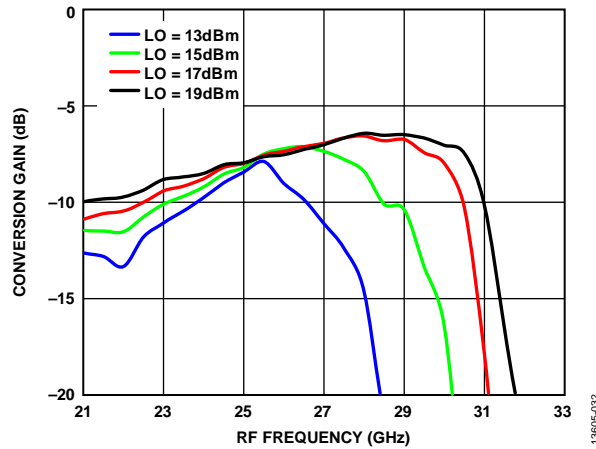

Figure 34. Conversion Gain vs. RF Frequency at Various LO Powers,  $T_A = 25^\circ\text{C}$

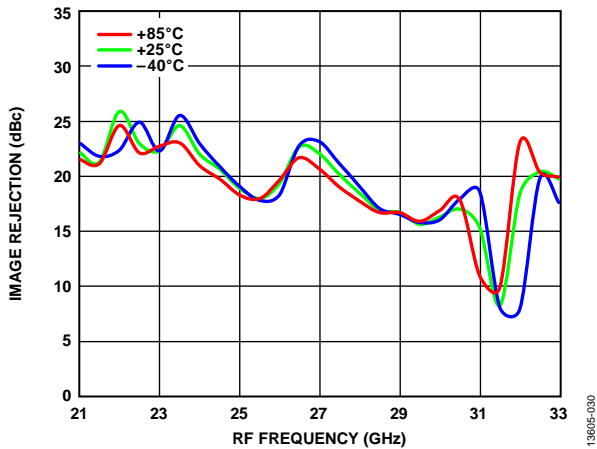

Figure 32. Image Rejection vs. RF Frequency at Various Temperatures

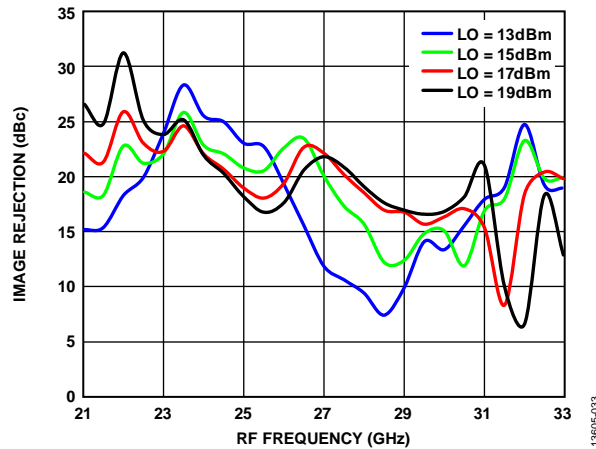

Figure 35. Image Rejection vs. RF Frequency at Various LO Powers,  $T_A = 25^\circ\text{C}$

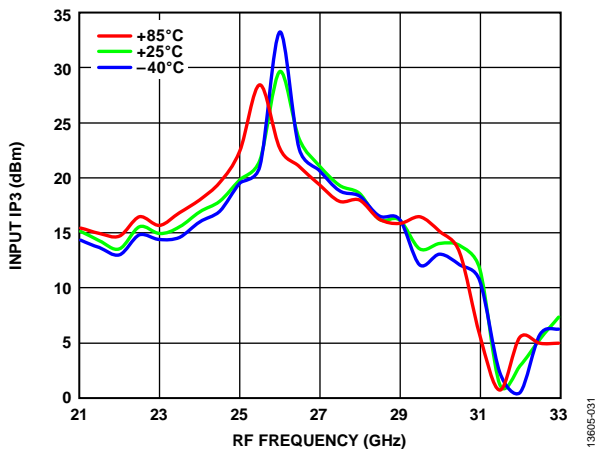

Figure 33. Input IP3 vs. RF Frequency at Various Temperatures

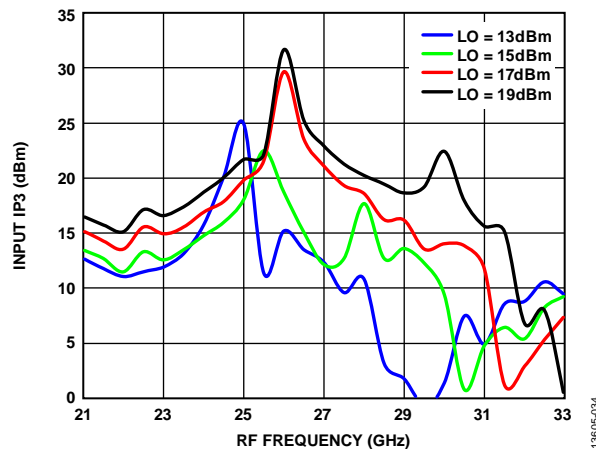

Figure 36. Input IP3 vs. RF Frequency at Various LO Powers,  $T_A = 25^\circ\text{C}$

**DOWNCONVERTER PERFORMANCE: IF BANDWIDTH, UPPER SIDEBAND (LOW-SIDE LO)**

Data taken as an image reject mixer with external 90° hybrid at the IF ports, LO = 17 dBm at 24 GHz, unless otherwise noted.

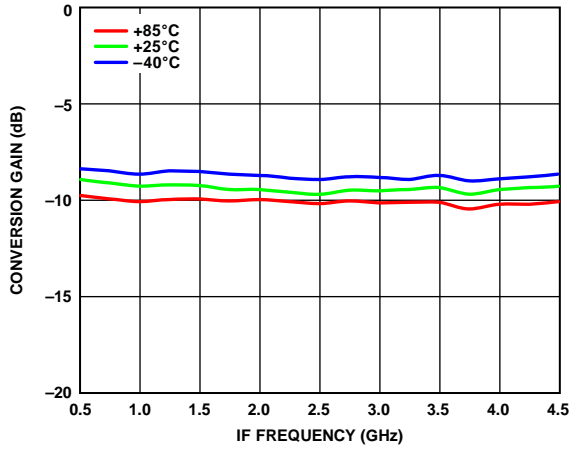

Figure 37. Conversion Gain vs. IF Frequency at Various Temperatures

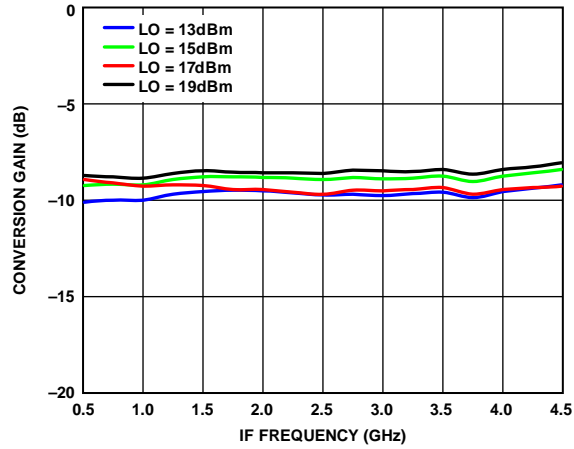

Figure 40. Conversion Gain vs. IF Frequency at Various LO Powers,  $T_A = 25^\circ\text{C}$

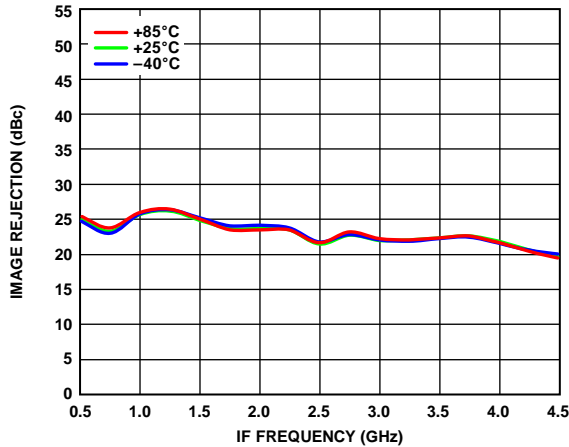

Figure 38. Image Rejection vs. IF Frequency at Various Temperatures

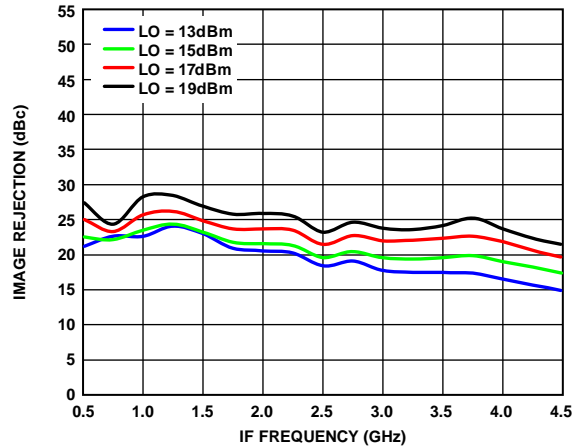

Figure 41. Image Rejection vs. IF Frequency at Various LO Powers,  $T_A = 25^\circ\text{C}$

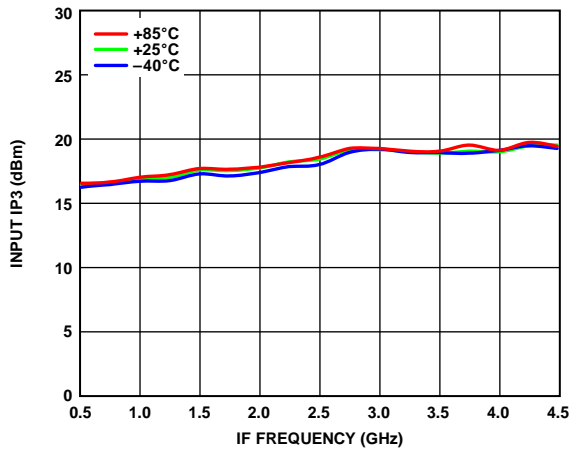

Figure 39. Input IP3 vs. IF Frequency at Various Temperatures

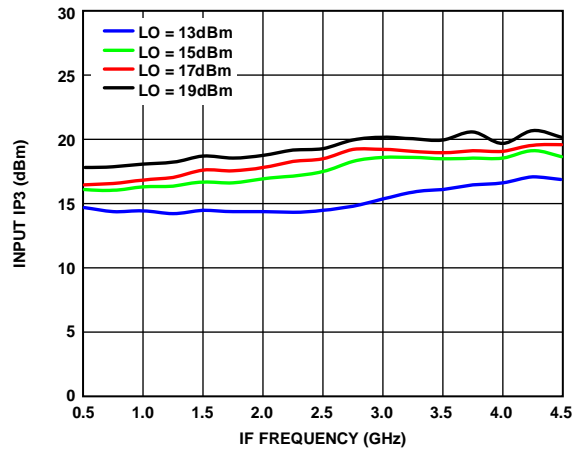

Figure 42. Input IP3 vs. IF Frequency at Various LO Powers,  $T_A = 25^\circ\text{C}$

**DOWNCONVERTER PERFORMANCE: IF BANDWIDTH, LOWER SIDEBAND (HIGH-SIDE LO)**

Data taken as an image reject mixer with external 90° hybrid at the IF ports, LO = 17 dBm at 24 GHz, unless otherwise noted.

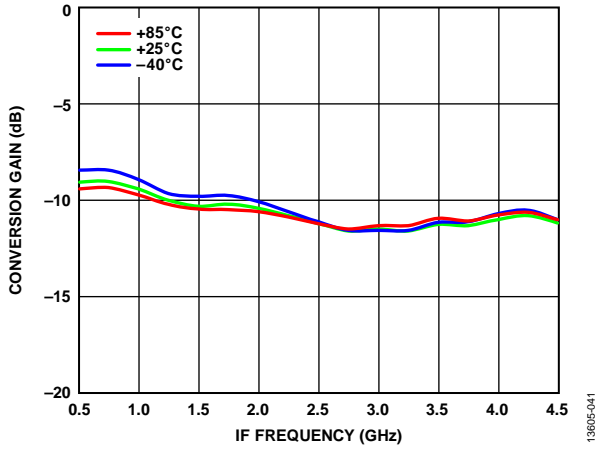

Figure 43. Conversion Gain vs. IF Frequency at Various Temperatures

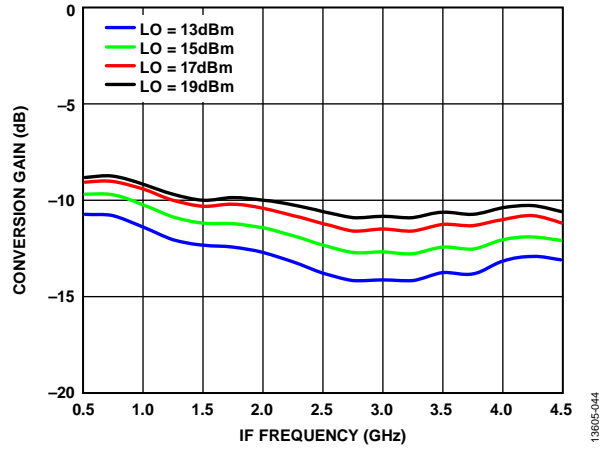

Figure 46. Conversion Gain vs. IF Frequency at Various LO Powers,  $T_A = 25^\circ\text{C}$

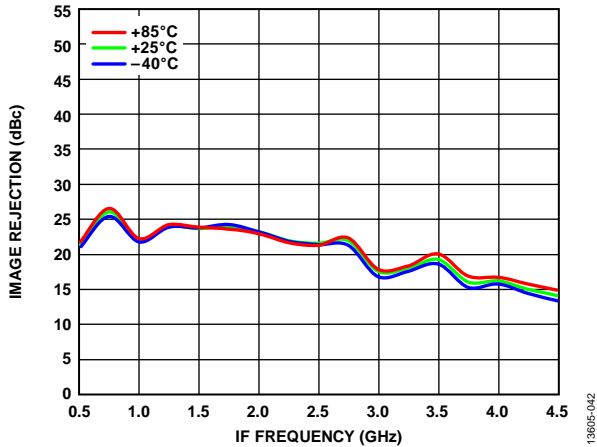

Figure 44. Image Rejection vs. IF Frequency at Various Temperatures

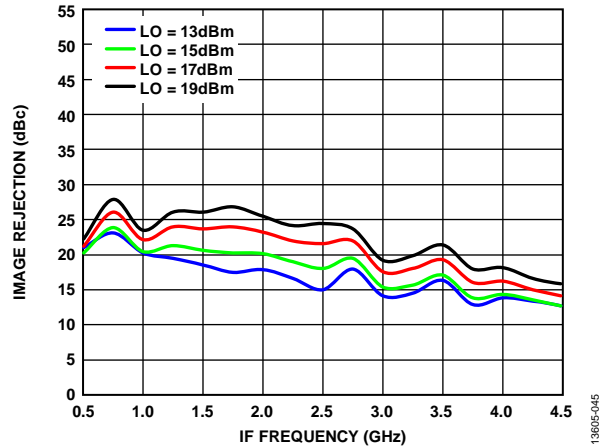

Figure 47. Image Rejection vs. IF Frequency at Various LO Powers,  $T_A = 25^\circ\text{C}$

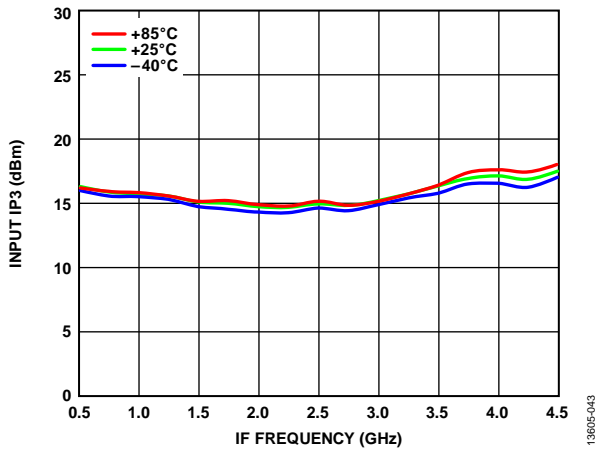

Figure 45. Input IP3 vs. IF Frequency at Various Temperatures

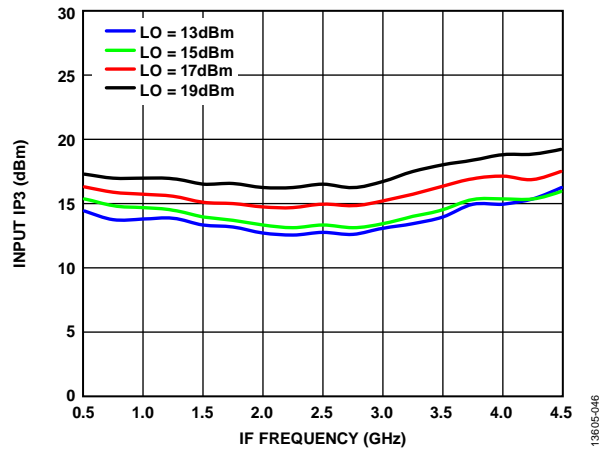

Figure 48. Input IP3 vs. IF Frequency at Various LO Powers,  $T_A = 25^\circ\text{C}$

**UPCONVERTER PERFORMANCE:  $I_{F_{IN}} = 100$  MHz, UPPER SIDEBAND (LOW-SIDE LO)**

Data taken as a single sideband upconverter with external 90° hybrid at the IF ports, LO = 17 dBm, unless otherwise noted.

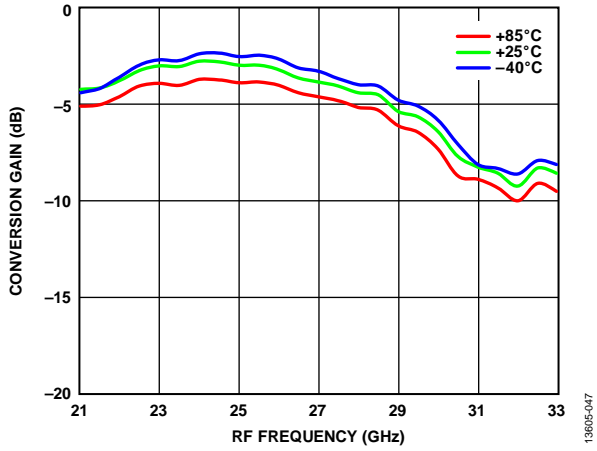

Figure 49. Conversion Gain vs. RF Frequency at Various Temperatures

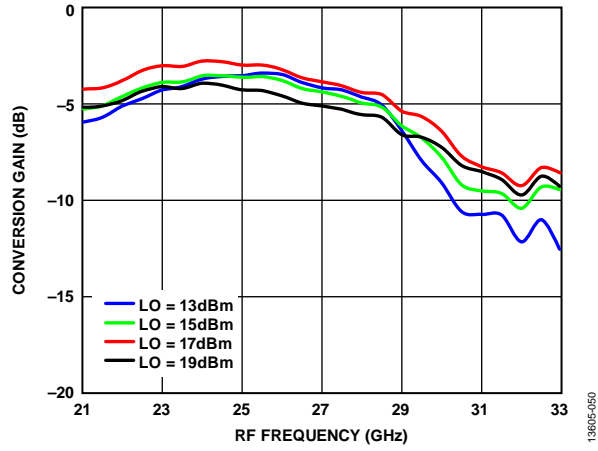

Figure 52. Conversion Gain vs. RF Frequency at Various LO Powers  
 $T_A = 25^\circ\text{C}$

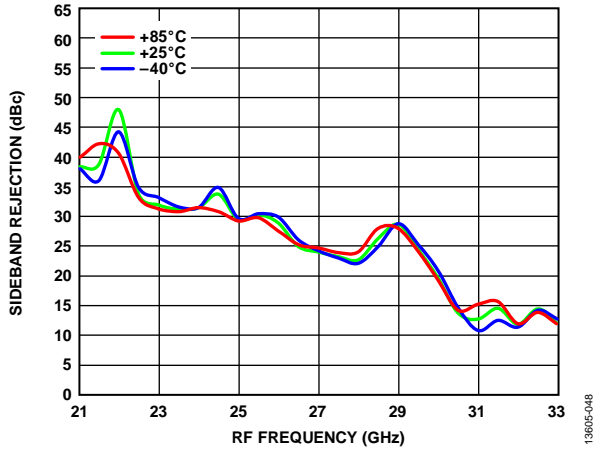

Figure 50. Sideband Rejection vs. RF Frequency at Various Temperatures

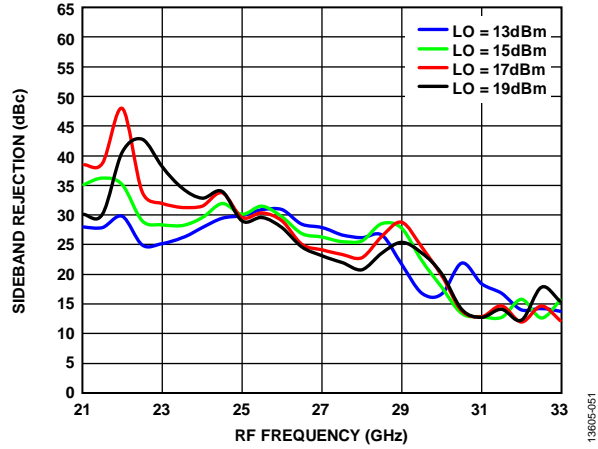

Figure 53. Sideband Rejection vs. RF Frequency at Various LO Powers,  
 $T_A = 25^\circ\text{C}$

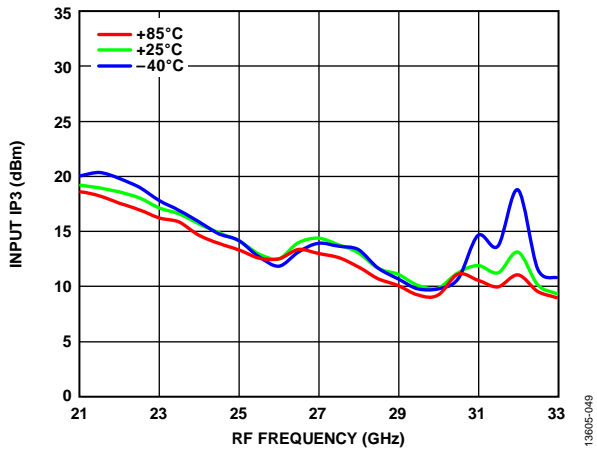

Figure 51. Input IP3 vs. RF Frequency at Various Temperatures

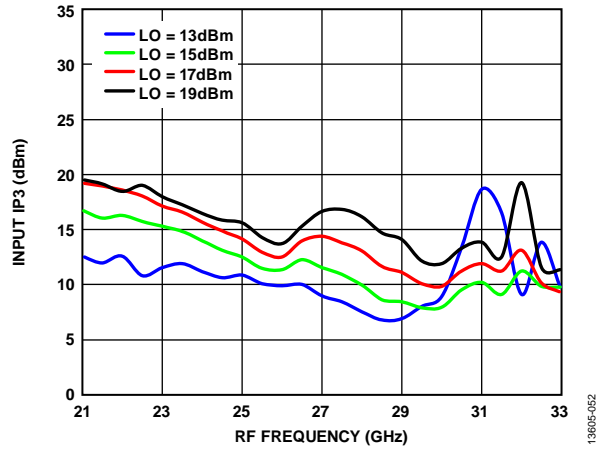

Figure 54. Input IP3 vs. RF Frequency at Various LO Powers,  $T_A = 25^\circ\text{C}$

**UPCONVERTER PERFORMANCE:  $I_{F_{IN}} = 100 \text{ MHz}$ , LOWER SIDEBAND (HIGH-SIDE LO)**

Data taken as a single sideband upconverter with external  $90^\circ$  hybrid at the IF ports, LO = 17 dBm, unless otherwise noted.

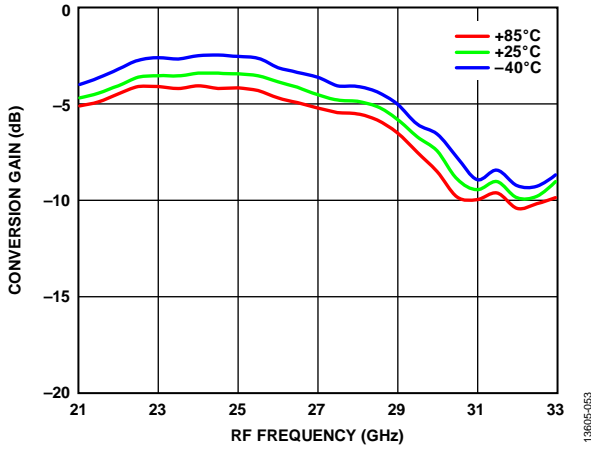

Figure 55. Conversion Gain vs. RF Frequency at Various Temperatures

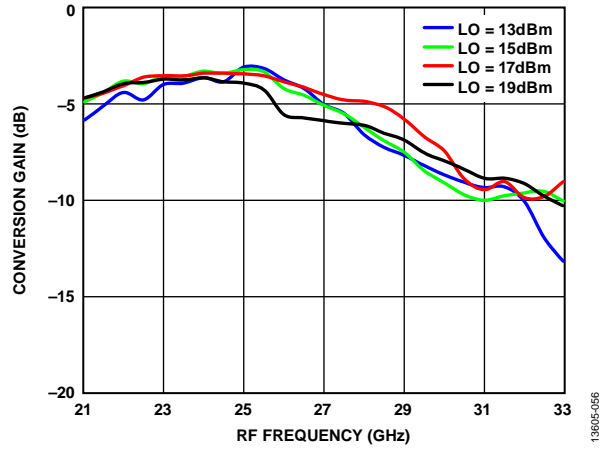

Figure 58. Conversion Gain vs. RF Frequency at Various LO Powers,  $T_A = 25^\circ\text{C}$

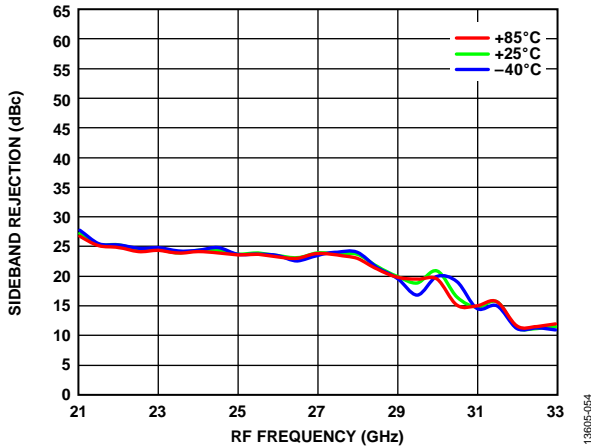

Figure 56. Sideband Rejection vs. RF Frequency at Various Temperatures

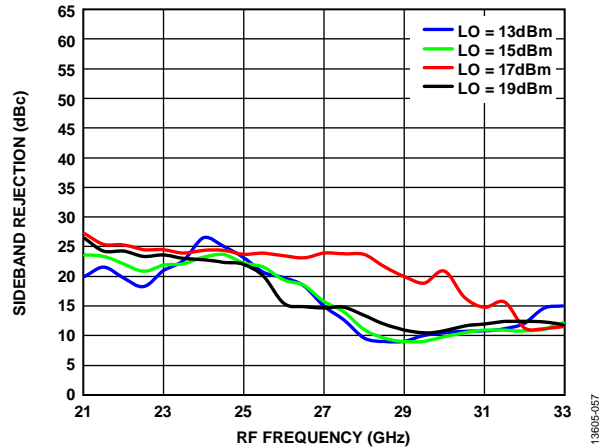

Figure 59. Sideband Rejection vs. RF Frequency at Various LO Powers,  $T_A = 25^\circ\text{C}$

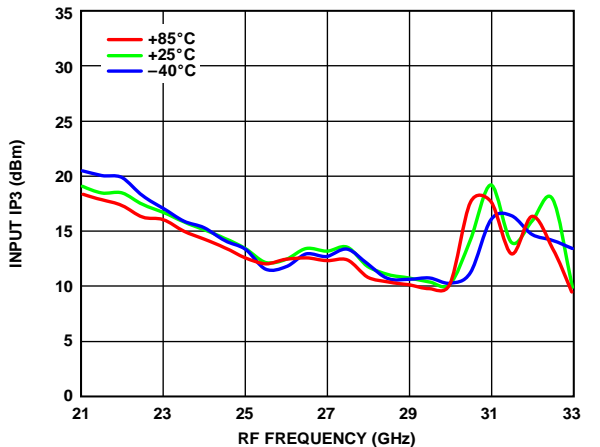

Figure 57. Input IP3 vs. RF Frequency at Various Temperatures

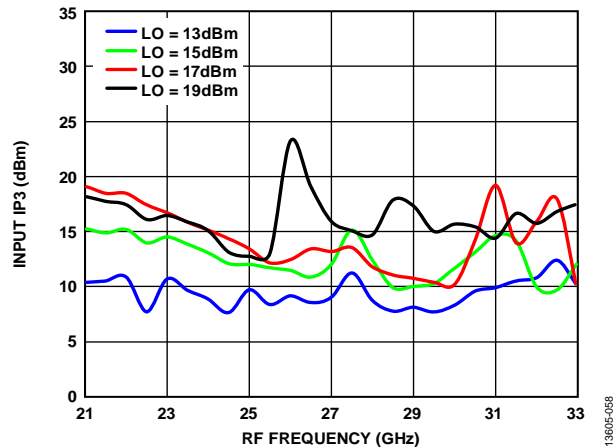

Figure 60. Input IP3 vs. RF Frequency at Various LO Powers,  $T_A = 25^\circ\text{C}$

**UPCONVERTER PERFORMANCE:  $IF_{IN} = 2500$  MHz, UPPER SIDEBAND (LOW-SIDE LO)**

Data taken as a single sideband upconverter with external 90° hybrid at the IF ports, LO = 17 dBm, unless otherwise noted.

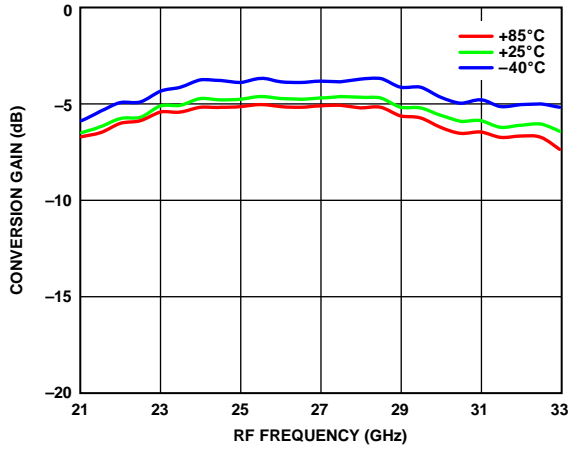

Figure 61. Conversion Gain vs. RF Frequency at Various Temperatures

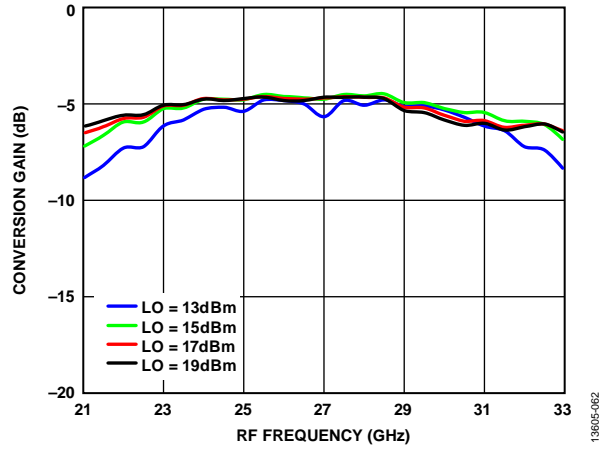

Figure 64. Conversion Gain vs. RF Frequency at Various LO Powers,  $T_A = 25^\circ\text{C}$

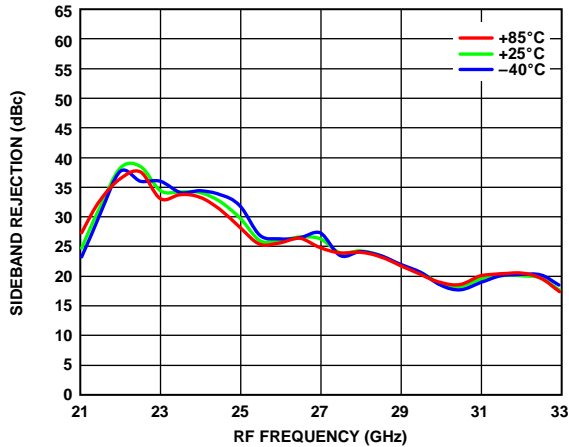

Figure 62. Sideband Rejection vs. RF Frequency at Various Temperatures

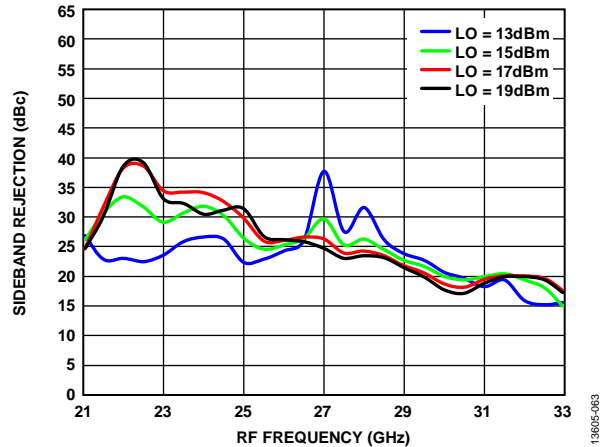

Figure 65. Sideband Rejection vs. RF Frequency at Various LO Powers,  $T_A = 25^\circ\text{C}$

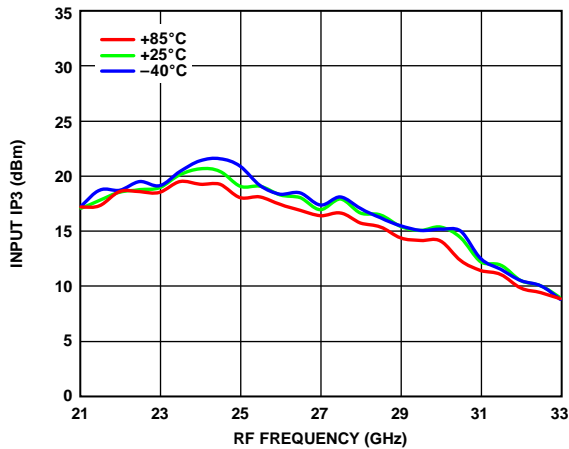

Figure 63. Input IP3 vs. RF Frequency at Various Temperatures

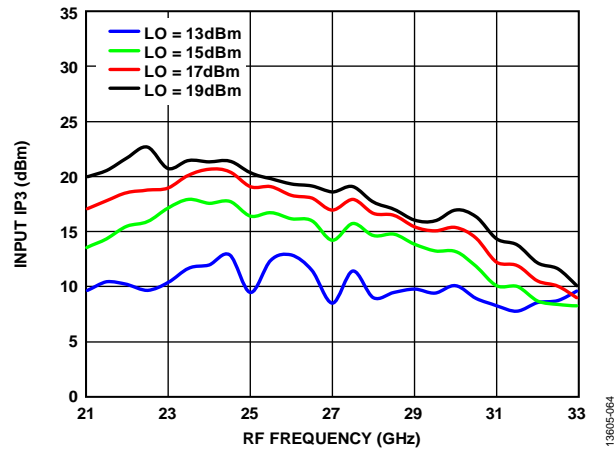

Figure 66. Input IP3 vs. RF Frequency at Various LO Powers,  $T_A = 25^\circ\text{C}$



**UPCONVERTER PERFORMANCE: IF<sub>IN</sub> = 2500 MHz, LOWER SIDEBAND (HIGH-SIDE LO)**

Data taken as a single sideband upconverter with external 90° hybrid at the IF ports, LO = 17 dBm, unless otherwise noted.

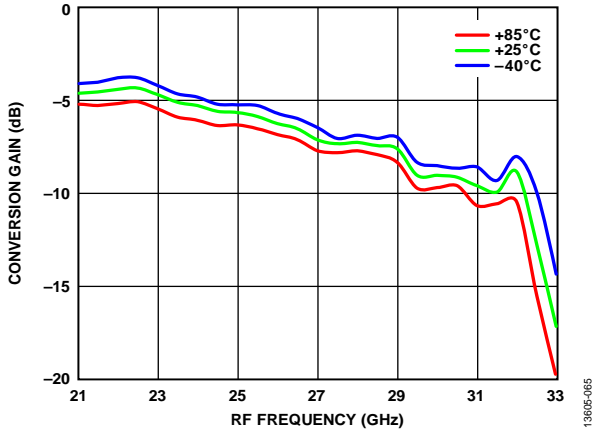

Figure 67. Conversion Gain vs. RF Frequency at Various Temperatures

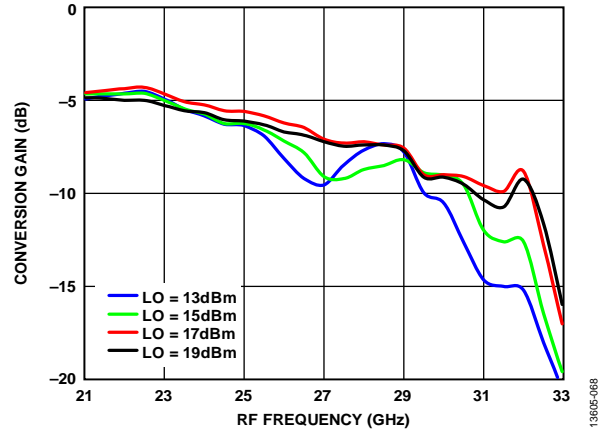

Figure 70. Conversion Gain vs. RF Frequency at Various LO Powers, T<sub>A</sub> = 25°C

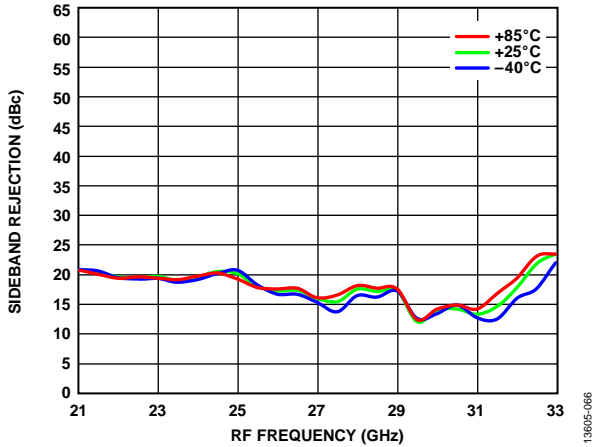

Figure 68. Sideband Rejection vs. RF Frequency at Various Temperatures

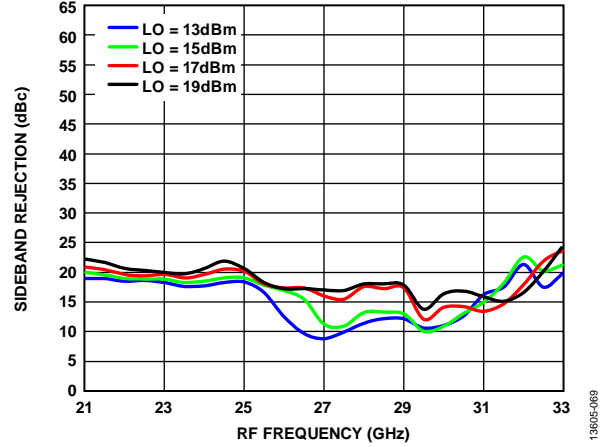

Figure 71. Sideband Rejection vs. RF Frequency at Various LO Powers, T<sub>A</sub> = 25°C

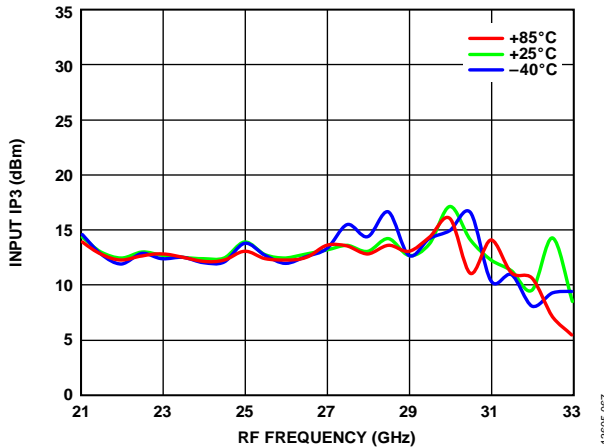

Figure 69. Input IP3 vs. RF Frequency at Various Temperatures

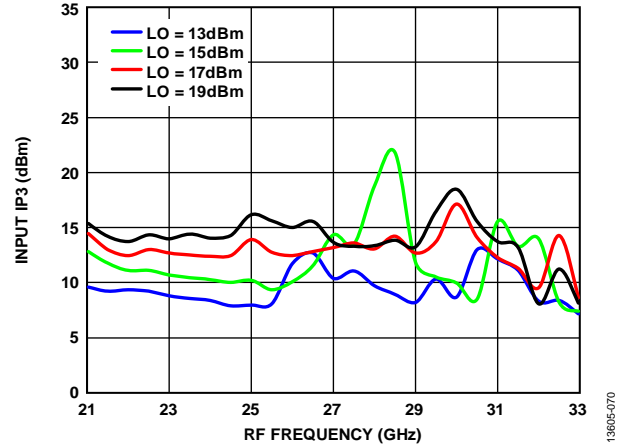

Figure 72. Input IP3 vs. RF Frequency at Various LO Powers, T<sub>A</sub> = 25°C

**AMPLITUDE/ PHASE BALANCE, DOWNCONVERTER: IF<sub>OUT</sub> = 100 MHz**

Data taken at various LO powers.

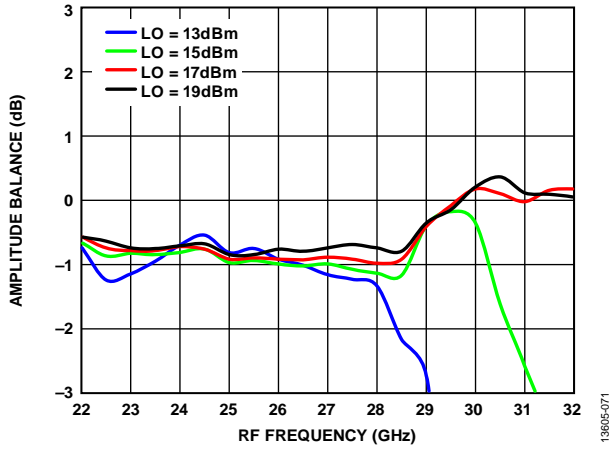

Figure 73. Amplitude Balance vs. RF Frequency at Various LO powers, Upper Sideband,  $T_A = 25^\circ\text{C}$

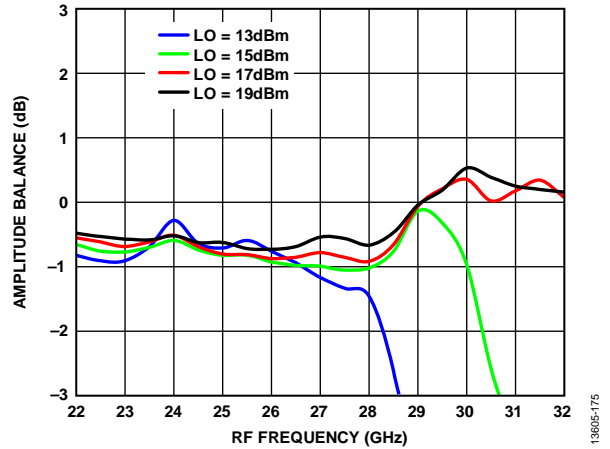

Figure 75. Amplitude Balance vs. RF Frequency at Various LO powers, Lower Sideband,  $T_A = 25^\circ\text{C}$

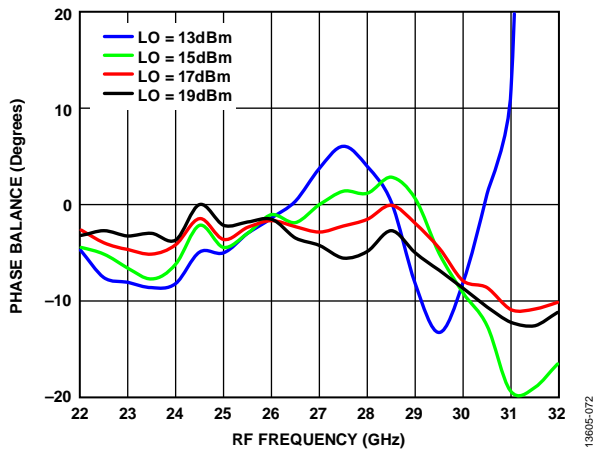

Figure 74. Phase Balance vs. RF Frequency at Various LO Powers, Upper Sideband,  $T_A = 25^\circ\text{C}$

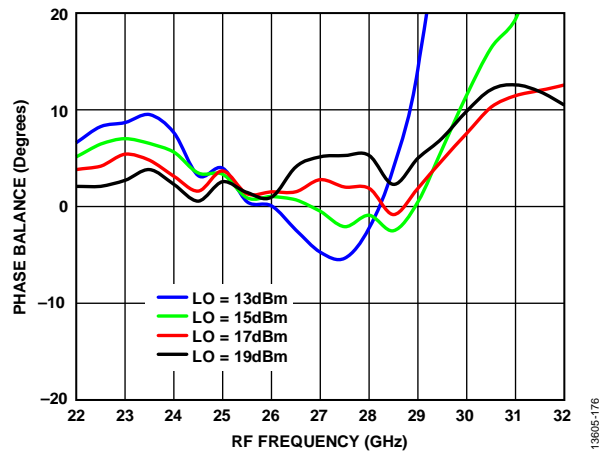

Figure 76. Phase Balance vs. RF Frequency at Various LO Powers, Lower Sideband,  $T_A = 25^\circ\text{C}$

ISOLATION AND RETURN LOSS

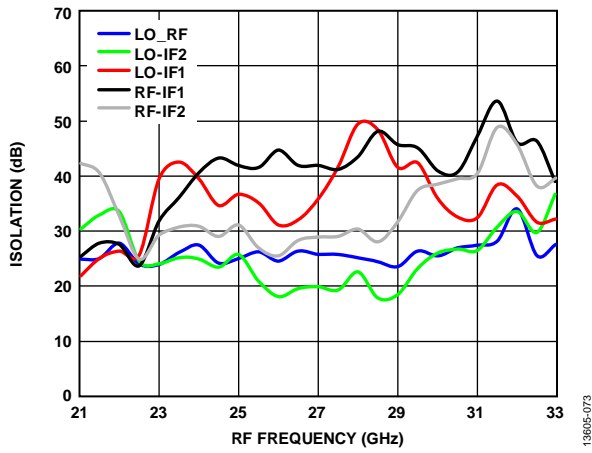

Figure 77. Isolation vs. RF Frequency at LO = 17 dBm,  $T_A = 25^\circ\text{C}$

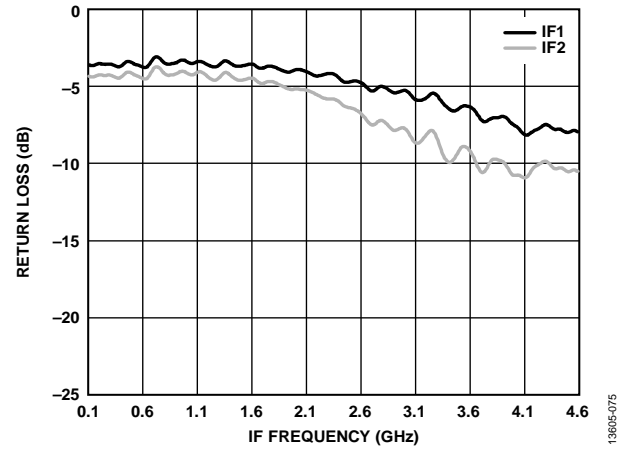

Figure 79. Return Loss vs. IF Frequency, LO = 17 dBm at 27 GHz,  $T_A = 25^\circ\text{C}$

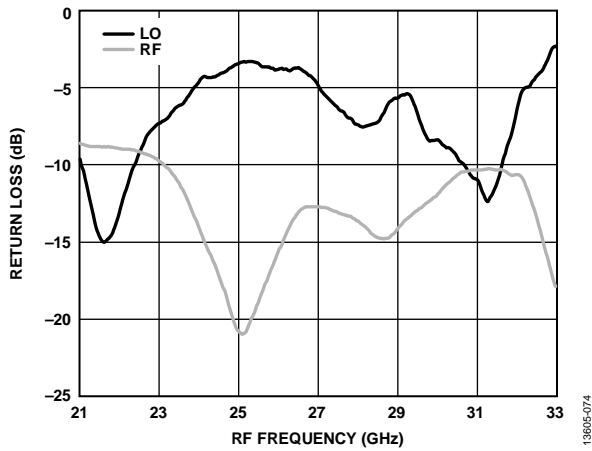

Figure 78. Return Loss vs. RF Frequency, LO = 17 dBm,  $T_A = 25^\circ\text{C}$

**M × N SPURIOUS OUTPUT PERFORMANCE**

**Downconverter, M × N**

RF = 24.5 GHz, LO = 24.4 GHz, RF power = -10 dBm, and LO power = 17 dBm, data taken without external hybrid. Mixer spurious products are measured in dBc from the IF output power level (M × RF) - (N × LO) are positive. N/A means not applicable.

		N × LO					
		0	1	2	3	4	5
M × RF	0	N/A	-2	+39	N/A	N/A	N/A
	1	+28	0	+52	+58	N/A	N/A
	2	+61	+72	+56	+73	+59	N/A
	3	N/A	+95	+73	+66	+73	+59
	4	N/A	N/A	+125	+73	+83	+73
	5	N/A	N/A	N/A	+159	+70	+85

**Upconverter, M × N**

IF = 100 MHz, LO = 24.4 GHz, IF power = -10 dBm, and LO power = 17 dBm, data taken without external hybrid. Mixer spurious products are measured in dBc from the RF output power level (M × IF) + (N × LO) are positive, unless otherwise noted.

		N × LO		
		0	1	2
M × IF	-5	+90	+79	+67
	-4	+90	+72	+68
	-3	+91	+52	+67
	-2	+68	+40	+58
	-1	+88	0	+32
	0	0	-5	+22
	+1	+89	0	+32
	+2	+67	+41	+58
	+3	+89	+52	+69
	+4	+89	+74	+67
	+5	+88	+77	+67

## THEORY OF OPERATION

The HMC524ALC3B is a compact GaAs MMIC I/Q mixer in a leadless RoHS compliant SMT ceramic package. This device is either an image reject mixer or a single-sideband upconverter.

When used as an image reject mixer, the HMC524ALC3B downconverts radio frequencies between 22 GHz and 32 GHz to intermediate frequencies between dc and 4.5 GHz.

When used as single-sideband upconverter, the HMC524ALC3B upconverts IF between dc and 4.5 GHz to RF between 22 GHz and 32 GHz

### APPLICATIONS INFORMATION

Figure 80 shows the typical application circuit for the HMC524ALC3B. To select the appropriate sideband, an external 90° hybrid coupler is needed. For applications not requiring operation to dc, use an off chip dc blocking capacitor. For applications that require the LO signal at the output to be suppressed, use a bias tee or RF feed as shown in Figure 80. Ensure that the source or sink current used for LO suppression is <2 mA for each IF port to prevent damage to the device. The common-mode voltage for each IF port is 0 V.

To select the upper sideband when using as an upconverter, connect the IF1 pin to the 90° port of the hybrid and connect the IF2 pin to the 0° port of the hybrid. To select the lower sideband, connect the IF1 pin to the 0° port of the hybrid and connect the IF2 pin to the 90° port of the hybrid. The input is from the sum port of the hybrid, and the difference port is 50 Ω terminated.

To select the upper sideband (low-side LO) when using as a downconverter, connect the IF1 pin to the 0° port of the hybrid and connect the IF2 pin to the 90° port of the hybrid. To select the lower sideband (high-side LO), connect the IF1 pin to the 90° port of the hybrid and connect the IF2 pin to the 0° port of the hybrid. The output is from the sum port of the hybrid, and the difference port is 50 Ω terminated.

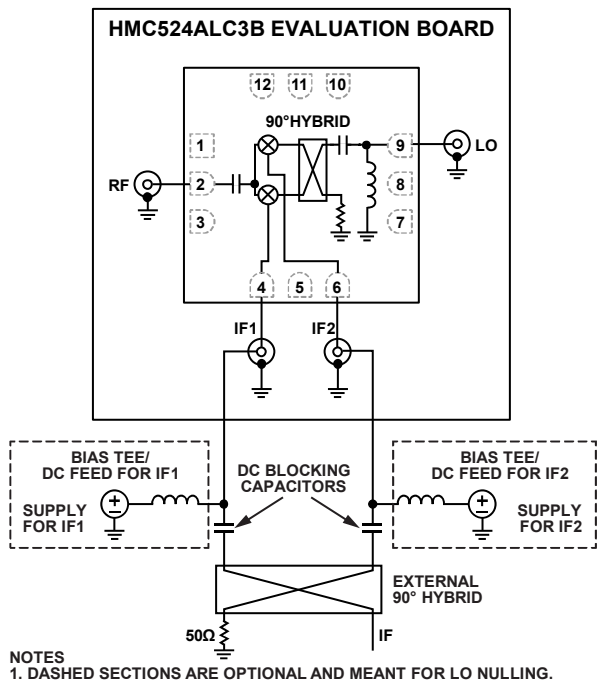

Figure 80. Typical Application Circuit Evaluation Board Information

The EV1HMC524ALC3B evaluation PCB used in the application must use RF circuit design techniques. Signal lines must have 50 Ω impedance, and connect the package ground leads and exposed pad directly to the ground plane similarly to Figure 82. Use a sufficient number of via holes to connect the top and bottom ground planes. The evaluation circuit board shown in Figure 82 is available from Analog Devices, Inc., upon request.

### LAYOUT

Solder the exposed pad on the underside of the HMC524ALC3B to a low thermal and electrical impedance ground plane. This pad is typically soldered to an exposed opening in the solder mask on the evaluation board. Connect these ground vias to all other ground layers on the evaluation board to maximize heat dissipation from the device package. Figure 81 shows the PCB land pattern footprint for the EV1HMC524ALC3B evaluation board.

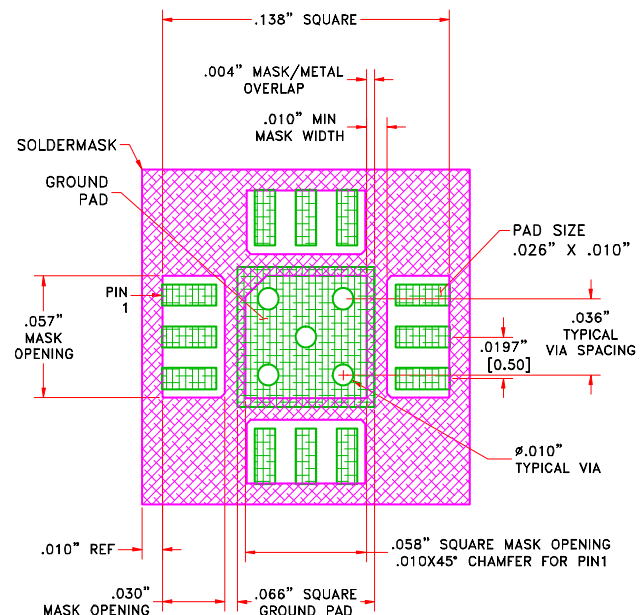

Figure 81. PCB Land Pattern Footprint of the EV1HMC524ALC3B

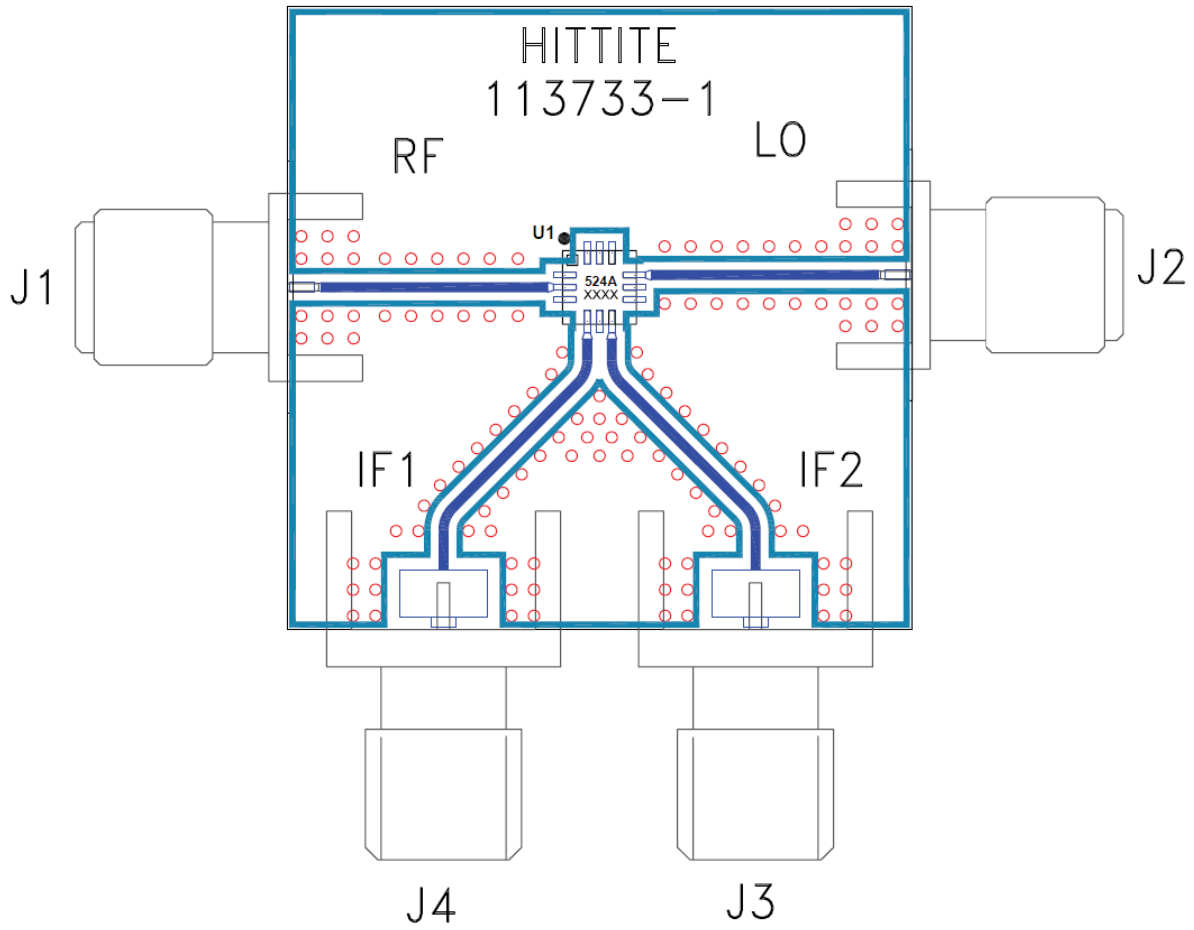

Figure 82. EV1HMC524ALC3B (113733-1) Evaluation PCB Top Layer

13805-077

Table 5. Bill of Materials for the EV1HMC524ALC3B (113733-1) Evaluation PCB

Quantity	Reference Designator	Description	Part Number
1	113733-1	PCB, EV1HMC524ALC3B	113733-1
2	J1 (connects to RF), J2 (connects to LO)	2.92 mm subminiature version A (SMA) connectors, SRI connector gage	104935
2	J3 (connects to IF1), J4 (connects to IF2)	Gold plated SMA, edge mount with 0.02 inch pin connectors, Johnson SMA connectors	105192
1	U1	Device under test, HMC524ALC3B	HMC524ALC3B

OUTLINE DIMENSIONS

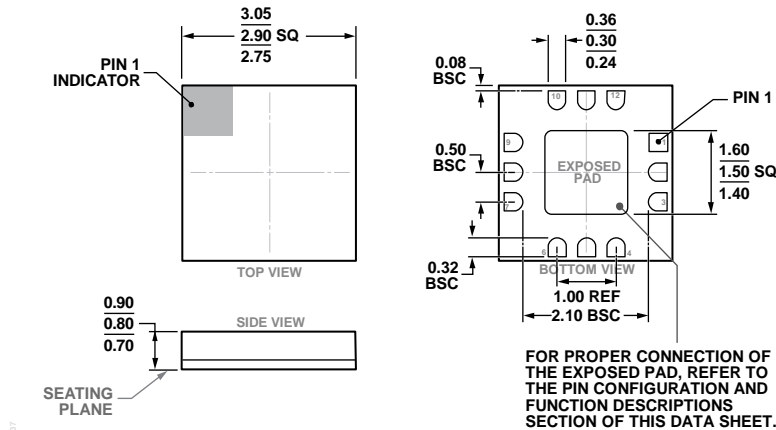

Figure 83. 12-Terminal Ceramic Leadless Chip Carrier (LCC)  
(E-12-4)  
Dimensions shown in millimeters

ORDERING GUIDE

Model <sup>1</sup>	Temperature Range	Package Body Material	Lead Finish	Package Description	Package Option
HMC524ALC3B	-40°C to +85°C	Alumina Ceramic	Gold over Nickel	12-Terminal LCC	E-12-4
HMC524ALC3BTR	-40°C to +85°C	Alumina Ceramic	Gold over Nickel	12-Terminal LCC	E-12-4
HMC524ALC3BTR-R5	-40°C to +85°C	Alumina Ceramic	Gold over Nickel	12-Terminal LCC	E-12-4
EV1HMC524ALC3B				Evaluation Board	

<sup>1</sup> All models are RoHS compliant parts.