

## 1. ELECTRICAL SPECIFICATIONS @25°C

- 1.1 OCL: 350 uH Min @ 100 KHz, 0.1V with 8mA DC Bias
- 1.2 Leakage Inductance: 0.5uH Max @ 100KHz, 0.2V
- 1.3 DCR: 1.4Ω Max
- 1.4 Turns Ratio: 1CT:1CT
- 1.5 Polarity: 1-36, 3-34, 5-32, 7-30.10-27, 12-25, 14-23, 16-21 In-Phase
- 1.6 Insertion Loss: -1.0 dB Max. @ 0.3-100 MHz
- 1.7 Return Loss: -18 dB Min. @ 1-30 MHz
  - 14 dB Min. @ 30-60 MHz
  - 12 dB Min. @ 60-80 MHz
  - 10 dB Min. @ 80-100 MHz
- 1.8 Cross Talk: -30 dB Min @ 1-100 MHz
- 1.9 Common Mode Rejection : -30 dB Min @ 1-100 MHz
- 1.10 Isolation HI-POT: 1500Vrms 2mA 60Second
- 1.11 Operating temperature 0°C to +70°C
- 1.12 Storage temperature -40°C to +85°C

DRAWN BY:	CHECKED BY:	APPROVED BY:	CUSTOMER BY:
			FPE PART NO : G36501DK-R
	GuangDong Misun Technology Co., Ltd		REV: A
			PAGE: 1 / 2

## 2. SCHEMATICS

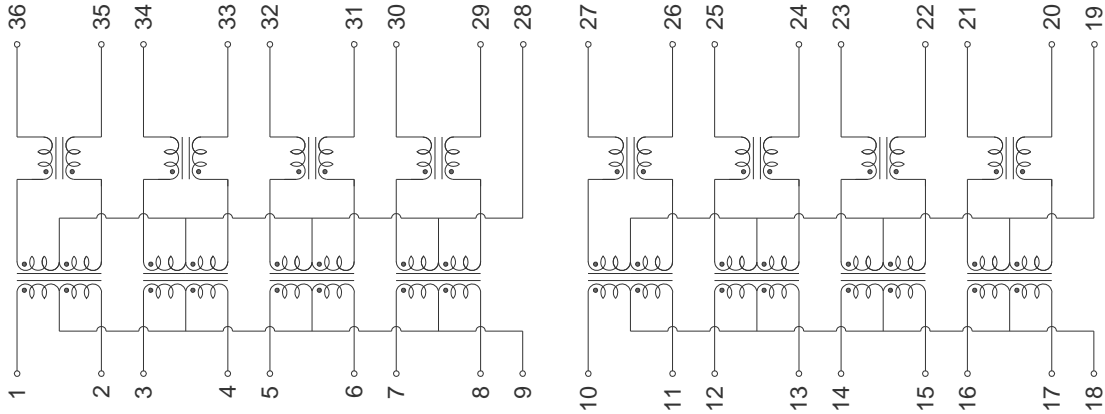

## 3. DIMENSIONS & MARKING

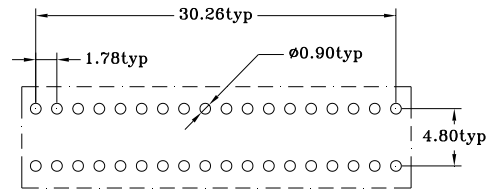
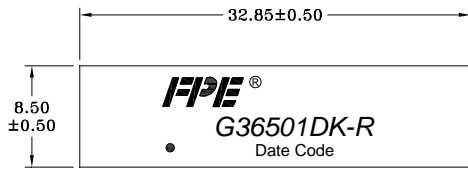

SUGGESTED PCB LAYOUT

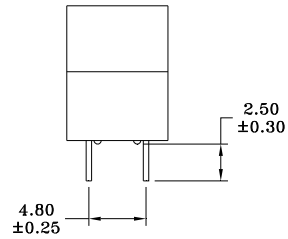
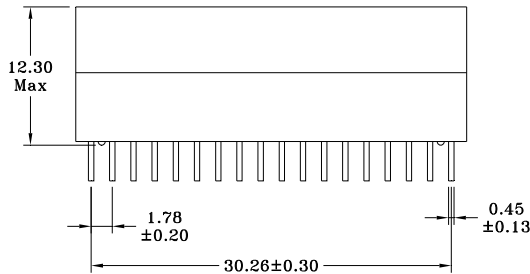

DRAWN BY:	CHECKED BY:	APPROVED BY:	CUSTOMER BY:
			FPE PART NO : G36501DK-R
	GuangDong Misun Technology Co., Ltd		REV: A
			PAGE: 2 / 2