

SML-31 series

1608(0603)
1.6×0.8mm(t=0.8mm)

Features

- 1608 standard size(1.6×0.8mm, t=0.8mm)
- Abundant color variations with diverse luminous intensity types



Product Specifications

| Part No. | LED chip | Emitting color | Absolute maximum ratings (Ta=25°C) | | | | | | Electrical and optical characteristics (Ta=25°C) | | | | | | | | | | |
|-----------------|-----------------|-----------------|------------------------------------|------------------------|------------------------------|-----------------------|--------------------------------|------------------------------|--|-----|-------------------------|---|-----------------------------|--------------|-----|-----------------------------|-----|-----|------|
| | | | Power dissipation PD(mW) | Forward current IF(mA) | Peak forward current IFP(mA) | Reverse voltage VR(V) | Operating temperature Topr(°C) | Storage temperature Tsig(°C) | Forward voltage VF (V) | | Reverse current IR (μA) | | Dominant wavelength λD (nm) | | | Luminous intensity Iv (mcd) | | | |
| ■ SML-310VT | GaAsP on GaP | Red | 55 | | | | | | 2 | 20 | | | 625 | 630 | 635 | 20 | 1.4 | 4 | 20 |
| ■ SML-311UT | AlGaInP on GaAs | | | 44 | | | | | | 1.8 | 2 | | | 615 | 620 | 625 | 2 | 0.9 | 2.5 |
| ■ SML-311DT | | | Orange | | | | | | | | | | | 602 | 605 | 608 | | 1.6 | 3.15 |
| ■ SML-310DT | GaAsP on GaP | | | 55 | | | | | | 2 | 20 | | | | | | 20 | 2.2 | 6.3 |
| ■ SML-311WT | AlGaInP on GaAs | Yellow | 44 | | 60±1 | 4 | | -40 to +85 | 1.8 | 2 | | 4 | 587 | 590 | 593 | 2 | 0.9 | 2.5 | 2 |
| ■ SML-311YT | | | | | | | | | | | | | | 584 | 587 | 590 | | 2.2 | 6.3 |
| ■ SML-310YT | GaAsP on GaP | Yellowish Green | 55 | 20 | | | | -30 to +85 | 2.1 | | | | | | | | | | |
| ■ SML-310MT | GaP | | | | | | | | | | | | | 2.2 | | 100 | | | 567 |
| ■ SML-310PT | | | Green | | | | | | | | | | 557 | 560 | 563 | | 1.4 | 4 | |
| ■ SML312ECT | | Bluish Green | 84 | | 100±2 | | | | 3.3 | 20 | | | 520 | 527 | 535 | 20 | 90 | 200 | 20 |
| ■ SML312EC4T | | | | | | | | | | | | | | | | | | | |
| ■ SML312BCT | InGaIn on SiC | Blue | | | | 5 | | | 3.3 | | 5 | | 464 | 470 | 476 | | 22 | 63 | |
| ■ SML312BC4T | | | | | | | | | | | | | | | | 3.2 | | 460 | 466 |
| ■ SML310BAT | | | 94 | | 70±2 | | | | 3.8 | | | | | | | | | | |
| □ SML312WBCW(A) | | White | 108 | 30 | 100±2 | | | -40 to +100 | 3.0 | 5 | | | (x, y) | (0.30, 0.29) | 5 | 45 | 71 | 5 | |

※ 1:Duty1/5, 200Hz / ※ 2:Duty1/10, 1kHz

Dimensions

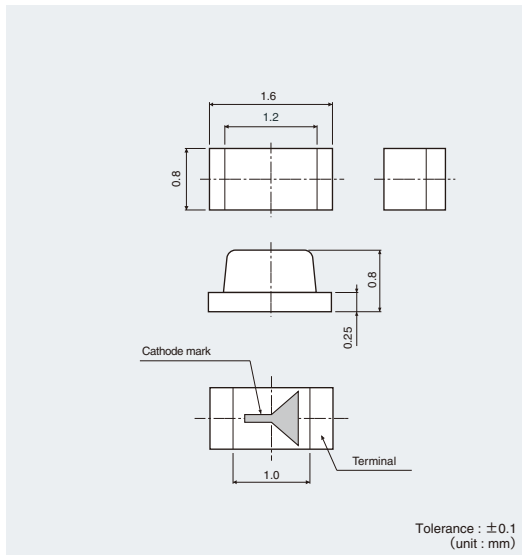

Recommended Solder Pattern Viewing Angle

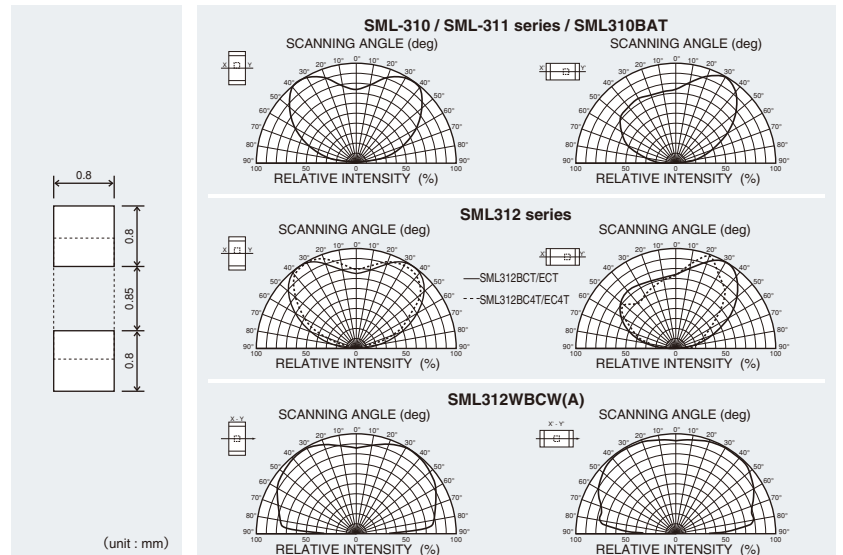

Electrical Characteristics Curves

Forward Current-Forward Voltage

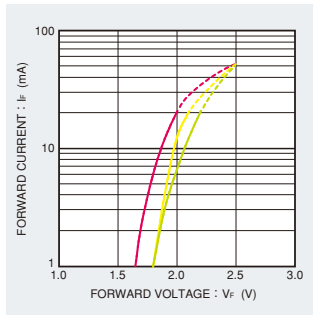

- SML-310VT
- SML-310DT
- SML-310YT
- SML-310MT
- SML-310PT
- SML-310YT

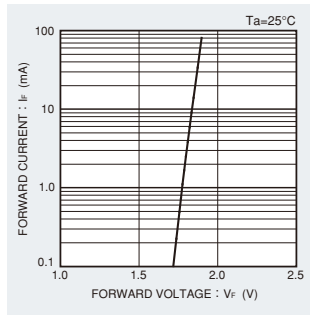

- SML-311UT
- SML-311DT
- SML-311WT
- SML-311YT

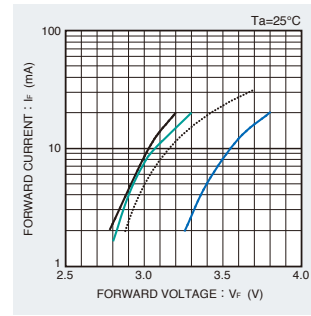

- SML312BC4T
- SML312EC4T
- SML312BCT
- SML312ECT
- SML312BAT
- SML312WBCW(A)

Luminous Intensity-Atmosphere Temperature

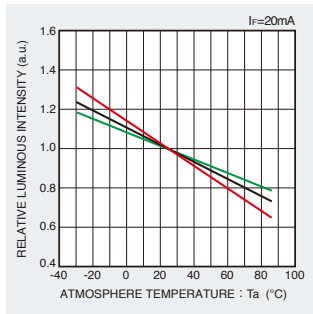

- SML-310VT
- SML-310DT
- SML-310YT
- SML-310MT
- SML-310PT

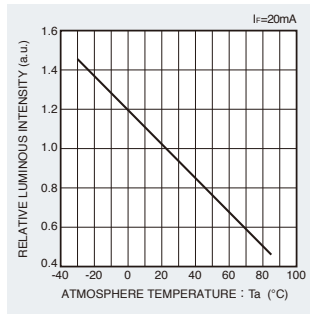

- SML-311UT
- SML-311DT
- SML-311WT
- SML-311YT

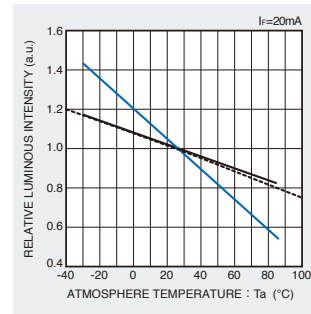

- SML312BC4T
- SML312EC4T
- SML312BCT
- SML312ECT
- SML312BAT
- SML312WBCW(A)

Luminous Intensity-Forward Current

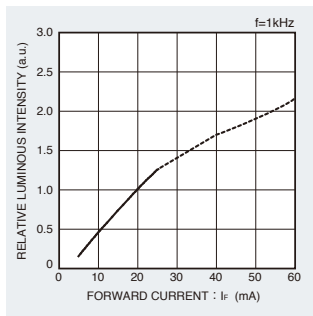

- SML-310VT
- SML-310DT
- SML-310YT
- SML-310MT
- SML-310PT

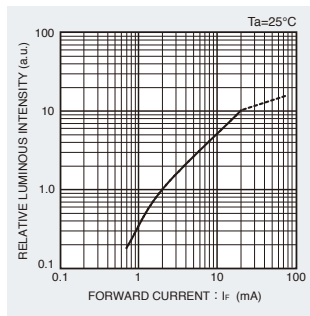

- SML-311UT
- SML-311DT
- SML-311WT
- SML-311YT

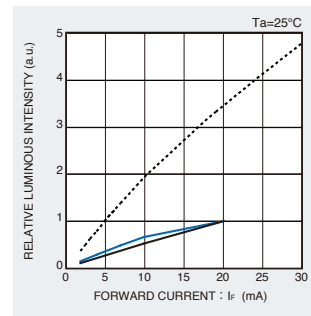

- SML312BC4T
- SML312EC4T
- SML312BCT
- SML312ECT
- SML312BAT
- SML312WBCW(A)

Deratings

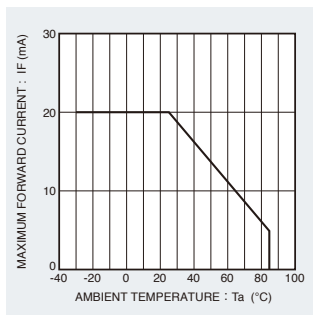

- SML-310VT
- SML-310DT
- SML-310YT
- SML-310MT
- SML-310PT

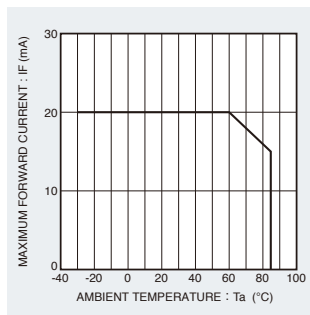

- SML-311UT
- SML-311DT
- SML-311WT
- SML-311YT

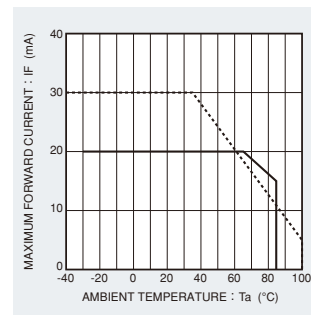

- SML312BC4T
- SML312EC4T
- SML312BCT
- SML312ECT
- SML312BAT
- SML312WBCW(A)

SML-31 series

Rank Reference of Brightness

Red (V, U)

(Ta=25°C, If=20mA)

| Package size(mm) | Height(mm) | Luminous Intensity (mcd) | G | H | J | K | L | M | N | P | Q | R | S | T | U | V | W | X | | |
|---------------------|------------|--------------------------|---------------------------|------------|------------|------------|-----------|----------|----------|----------|----------|-----------|------------|------------|------------|------------|-------------|--------------|--|--|
| | | | 1.0 to 1.6 | 1.6 to 2.5 | 2.5 to 4.0 | 4.0 to 6.3 | 6.3 to 10 | 10 to 16 | 16 to 25 | 25 to 40 | 40 to 63 | 63 to 100 | 100 to 160 | 160 to 250 | 250 to 400 | 400 to 630 | 630 to 1000 | 1000 to 1600 | | |
| Mini-mold Chip LEDs | 1608 | 0.8 | SML-311UT ^{※/※1} | | | | | | | | | | | | | | | | | |
| | | | SML-310VT [※] | | | | | | | | | | | | | | | | | |

Orange (D)

(Ta=25°C, If=2mA)

| Package size(mm) | Height(mm) | Luminous Intensity (mcd) | G | H | J | K | L | M | N | P | Q | R | S | T | U | V | W | X | |
|---------------------|------------|--------------------------|------------|------------|------------|------------|-----------|----------|----------|----------|----------|-----------|------------|------------|------------|------------|-------------|--------------|--|
| | | | 1.0 to 1.6 | 1.6 to 2.5 | 2.5 to 4.0 | 4.0 to 6.3 | 6.3 to 10 | 10 to 16 | 16 to 25 | 25 to 40 | 40 to 63 | 63 to 100 | 100 to 160 | 160 to 250 | 250 to 400 | 400 to 630 | 630 to 1000 | 1000 to 1600 | |
| Mini-mold Chip LEDs | 1608 | 0.8 | SML-311DT | | | | | | | | | | | | | | | | |

Yellow (Y, W)

(Ta=25°C, If=20mA)

| Package size(mm) | Height(mm) | Luminous Intensity (mcd) | G | H | J | K | L | M | N | P | Q | R | S | T | U | V | W | X | |
|---------------------|------------|--------------------------|---------------------------|------------|------------|------------|-----------|----------|------------------------|----------|----------|-----------|------------|------------|------------|------------|-------------|--------------|--|
| | | | 1.0 to 1.6 | 1.6 to 2.5 | 2.5 to 4.0 | 4.0 to 6.3 | 6.3 to 10 | 10 to 16 | 16 to 25 | 25 to 40 | 40 to 63 | 63 to 100 | 100 to 160 | 160 to 250 | 250 to 400 | 400 to 630 | 630 to 1000 | 1000 to 1600 | |
| Mini-mold Chip LEDs | 1608 | 0.8 | SML-311YT ^{※/※1} | | | | | | | | | | | | | | | | |
| | | | SML-311WT ^{※/※1} | | | | | | SML-310YT [※] | | | | | | | | | | |

Green (M, P, E)

(Ta=25°C, If=20mA)

| Package size(mm) | Height(mm) | Luminous Intensity (mcd) | F | G | H | J | K | L | M | N | P | Q | R | S | T | U | V | W | X |
|---------------------|------------|--------------------------|------------------------|------------|------------|------------|------------|-----------|-------------------------|----------|----------|----------|-----------|------------|------------|------------|------------|-------------|--------------|
| | | | 0.63 to 1.0 | 1.0 to 1.6 | 1.6 to 2.5 | 2.5 to 4.0 | 4.0 to 6.3 | 6.3 to 10 | 10 to 16 | 16 to 25 | 25 to 40 | 40 to 63 | 63 to 100 | 100 to 160 | 160 to 250 | 250 to 400 | 400 to 630 | 630 to 1000 | 1000 to 1800 |
| Mini-mold Chip LEDs | 1608 | 0.8 | SML-310MT [※] | | | | | | SML312ECT [※] | | | | | | | | | | |
| | | | SML-310PT [※] | | | | | | SML312EC4T [※] | | | | | | | | | | |

Blue (B)

(Ta=25°C, If=20mA)

| Package size(mm) | Height(mm) | Luminous Intensity (mcd) | G | H | J | K | L | M | N | P | Q | R | S | T | U | V | W | |
|---------------------|------------|--------------------------|------------|------------|------------|------------|------------|---------|------------|----------|----------|----------|-----------|------------|------------|------------|------------|--|
| | | | 0.9 to 1.4 | 1.4 to 2.2 | 2.2 to 3.6 | 3.6 to 5.6 | 5.6 to 9.0 | 9 to 14 | 14 to 22 | 22 to 36 | 36 to 56 | 56 to 90 | 90 to 140 | 140 to 220 | 220 to 360 | 360 to 560 | 560 to 900 | |
| Mini-mold Chip LEDs | 1608 | 0.8 | SML310BAT | | | | | | SML312BC4T | | | | | | | | | |
| | | | SML312BCT | | | | | | | | | | | | | | | |

White (WB)

(Ta=25°C, If=5mA)

| Package size(mm) | Height(mm) | Luminous Intensity (mcd) | P | Q | R | S | T | U | V | W | X1 | X2 | Y1 | Y2 | Z1 | |
|---------------------|------------|--------------------------|---------------|----------|----------|-----------|------------|------------|------------|------------|-------------|--------------|--------------|--------------|--------------|--|
| | | | 25 to 36 | 36 to 56 | 56 to 90 | 90 to 140 | 140 to 220 | 220 to 360 | 360 to 560 | 560 to 900 | 900 to 1100 | 1100 to 1400 | 1400 to 1800 | 1800 to 2200 | 2200 to 2800 | |
| Mini-mold Chip LEDs | 1608 | 0.8 | SML312WBCW(A) | | | | | | | | | | | | | |

※Brightness on specification sheet include tolerance of within ±10%. ※1:If=2mA

Part No. Construction

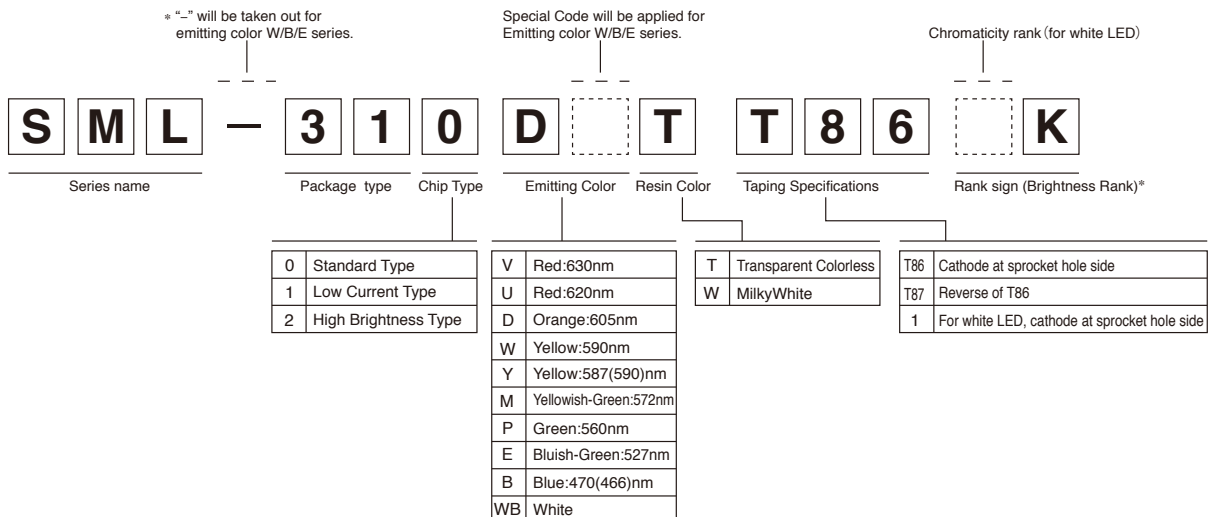

- Concerning the Brightness rank
 - Please refer to the rank chart above for luminous intensity classification.
 - Part name is individual for each rank.
 - When shipped as sample, the part name will be a representative part name.
- General products are free of ranks. Please contact sales if rank appointment is needed.

Packing Specification

ROHM LED products are being shipped with desiccant (silica gel) concluded in moisture-proof bags. Pasting the moisture sensitive label on the outer surface of the moisture-proof bags or enclosing the humidity indication card inside the bag is available upon request. Please contact the nearest sales office or distributor if necessary.

Notes

No copying or reproduction of this document, in part or in whole, is permitted without the consent of ROHM Co.,Ltd.

The content specified herein is subject to change for improvement without notice.

The content specified herein is for the purpose of introducing ROHM's products (hereinafter "Products"). If you wish to use any such Product, please be sure to refer to the specifications, which can be obtained from ROHM upon request.

Examples of application circuits, circuit constants and any other information contained herein illustrate the standard usage and operations of the Products. The peripheral conditions must be taken into account when designing circuits for mass production.

Great care was taken in ensuring the accuracy of the information specified in this document. However, should you incur any damage arising from any inaccuracy or misprint of such information, ROHM shall bear no responsibility for such damage.

The technical information specified herein is intended only to show the typical functions of and examples of application circuits for the Products. ROHM does not grant you, explicitly or implicitly, any license to use or exercise intellectual property or other rights held by ROHM and other parties. ROHM shall bear no responsibility whatsoever for any dispute arising from the use of such technical information.

The Products specified in this document are intended to be used with general-use electronic equipment or devices (such as audio visual equipment, office-automation equipment, communication devices, electronic appliances and amusement devices).

The Products specified in this document are not designed to be radiation tolerant.

While ROHM always makes efforts to enhance the quality and reliability of its Products, a Product may fail or malfunction for a variety of reasons.

Please be sure to implement in your equipment using the Products safety measures to guard against the possibility of physical injury, fire or any other damage caused in the event of the failure of any Product, such as derating, redundancy, fire control and fail-safe designs. ROHM shall bear no responsibility whatsoever for your use of any Product outside of the prescribed scope or not in accordance with the instruction manual.

The Products are not designed or manufactured to be used with any equipment, device or system which requires an extremely high level of reliability the failure or malfunction of which may result in a direct threat to human life or create a risk of human injury (such as a medical instrument, transportation equipment, aerospace machinery, nuclear-reactor controller, fuel-controller or other safety device). ROHM shall bear no responsibility in any way for use of any of the Products for the above special purposes. If a Product is intended to be used for any such special purpose, please contact a ROHM sales representative before purchasing.

If you intend to export or ship overseas any Product or technology specified herein that may be controlled under the Foreign Exchange and the Foreign Trade Law, you will be required to obtain a license or permit under the Law.



Thank you for your accessing to ROHM product informations.
More detail product informations and catalogs are available, please contact us.

ROHM Customer Support System

<http://www.rohm.com/contact/>