

»Features

- 350Watts peak pulse power ($t_p = 8/20\mu s$)
- Unidirectional configurations
- Solid-state silicon-avalanche technology
- Low clamping voltage
- Low leakage current
- IEC 61000-4-2 $\pm 30kV$ contact $\pm 30kV$ air
- IEC 61000-4-4 (EFT) 40A (5/50ns)
- IEC 61000-4-5 (Lightning) 17A (8/20 μs)



»Applications

- USB Vbus,
- Power Line
- Power management

»Mechanical Data

- SOD323 package
- Molding compound flammability rating: UL94V-0
- Packaging: Tape and Reel
- RoHS/WEEE Compliant

»Schematic & PIN Configuration

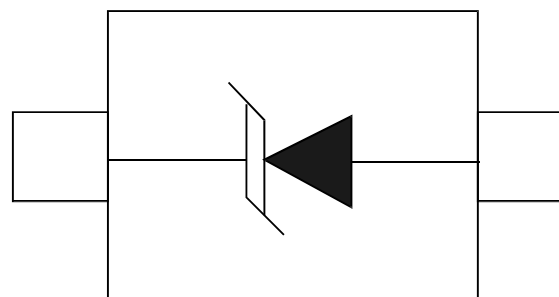

SOD-323

»Absolute Maximum Rating

| Rating | Symbol | Value | Units |
|--|-----------|----------------|-------|
| Peak Pulse Power ($t_p = 8/20\mu s$) | P_{PP} | 350 | Watts |
| Peak Pulse Current ($t_p = 8/20\mu s$) (note1) | I_{pp} | 17 | A |
| ESD per IEC 61000-4-2 (Air) ESD per IEC 61000-4-2 (Contact) | V_{ESD} | 30 30 | kV |
| Lead Soldering Temperature | T_L | 260(10seconds) | °C |
| Junction Temperature | T_J | -55 to + 150 | °C |
| Storage Temperature | T_{stg} | -55 to + 150 | °C |

»Electrical Characteristics

| Parameter | Symbol | Conditions | Min | Typical | Max | Units |
|---------------------------|-----------|---------------------------------|-----|---------|-----|---------|
| Reverse Stand-Off Voltage | V_{RWM} | | | | 5.0 | V |
| Reverse Breakdown Voltage | V_{BR} | $I_T = 1mA$ | 6.0 | | | V |
| Reverse Leakage Current | I_R | $V_{RWM} = 5V, T = 25^\circ C$ | | | 1 | μA |
| Clamping Voltage | V_C | $I_{PP} = 17A, t_p = 8/20\mu s$ | | 17 | 19 | V |
| Junction Capacitance | C_j | $V_R = 0V, f = 1MHz$ | | 120 | 135 | pF |

»Electrical Parameters (TA = 25°C unless otherwise noted)

| Symbol | Parameter |
|-----------|---|
| I_{PP} | Maximum Reverse Peak Pulse Current |
| V_C | Clamping Voltage @ I_{PP} |
| V_{RWM} | Working Peak Reverse Voltage |
| I_R | Maximum Reverse Leakage Current @ V_{RWM} |
| V_{BR} | Breakdown Voltage @ I_T |
| I_T | Test Current |
| | |
| | |

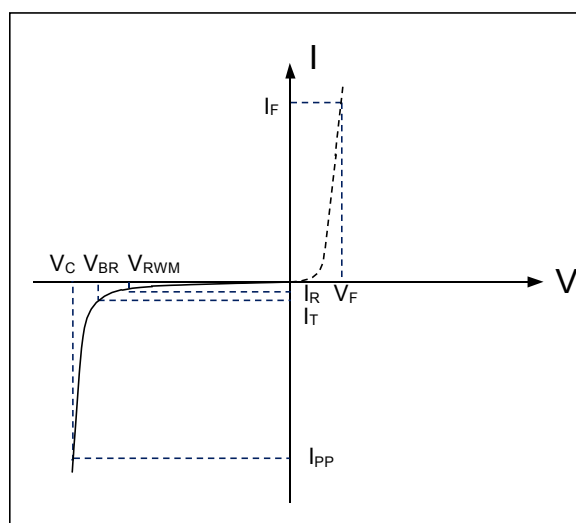

Note: 8/20 μs pulse waveform.

»Typical Characteristics

Figure 1: Peak Pulse Power vs. Pulse Time

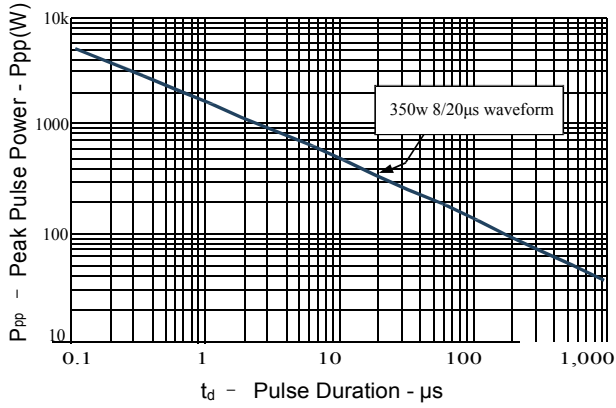

Figure 2: Power Derating Curve

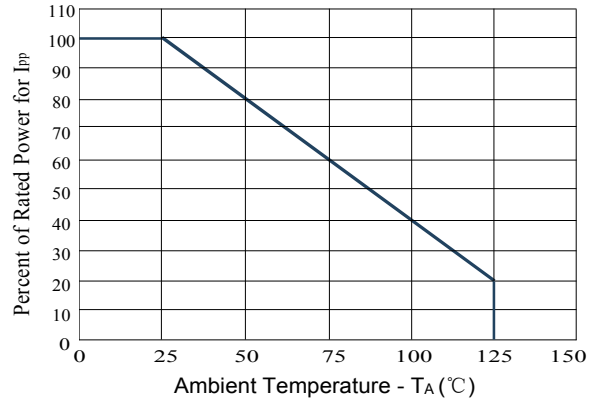

Figure3: Pulse Waveform

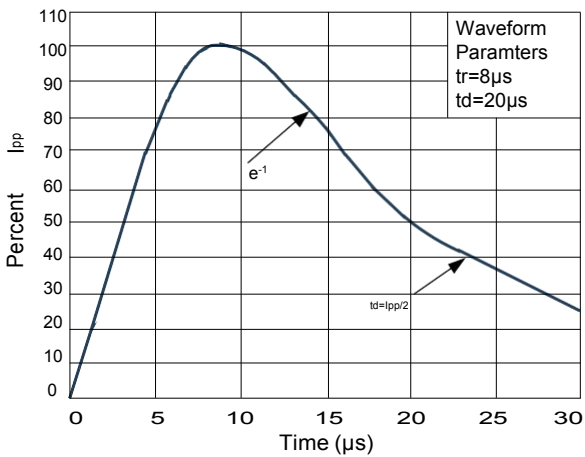
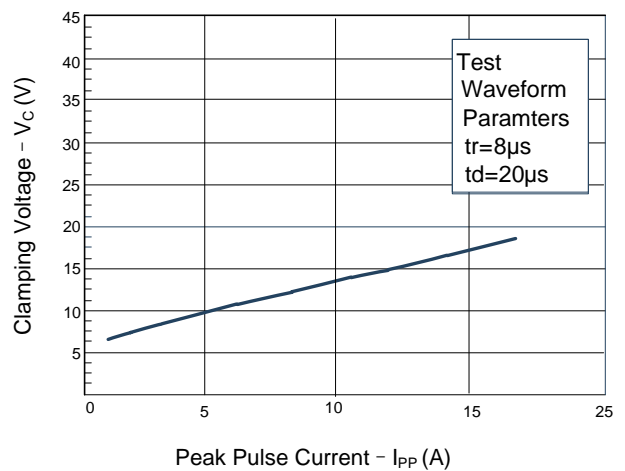
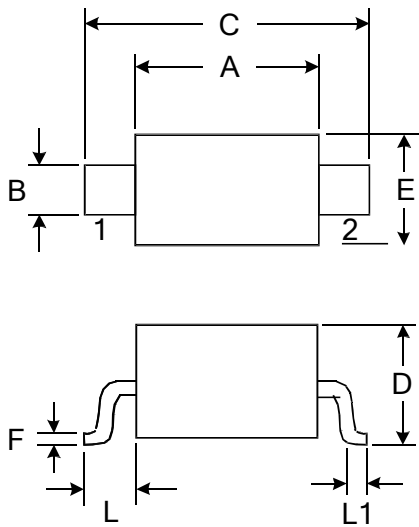

Figure 4: Clamping Voltage vs. Ipp



»Outline Drawing – SOD323



| DIMENSIONS | | | | |
|------------|------------|-------|----------|-------|
| SYMBOL | MILLIMETER | | INCHES | |
| | MIN | MAX | MIN | MAX |
| A | 1.600 | 1.800 | 0.063 | 0.071 |
| B | 0.250 | 0.350 | 0.010 | 0.014 |
| C | 2.500 | 2.700 | 0.098 | 0.106 |
| D | | 1.000 | | 0.039 |
| E | 1.200 | 1.400 | 0.047 | 0.055 |
| F | 0.080 | 0.150 | 0.003 | 0.006 |
| L | 0.475 REF | | 0.019REF | |
| L1 | 0.250 | 0.400 | 0.010 | 0.016 |
| H | 0.000 | 0.100 | 0.000 | 0.004 |

»Marking

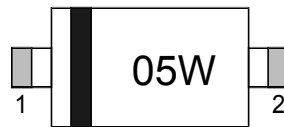

Pin Style: 1. Cathode 2. Anode

»Ordering information

| Order code | Package | Base qty | Delivery mode |
|------------|---------|----------|---------------|
| BSD3A051V | SOD323 | 3000 | Tape and reel |