

Features

- 400 watts Peak Pulse Power (10/1000 μ s)
- Unidirectional and Bidirectional Protection
- Fast Response Time : Typically < 1ps
- Excellent Clamping Capability
- Glass Passivated Junction
- Built-in Strain relief
- Low inductance
- Low profile package
- High temperature solder:260°C/20 seconds at terminal

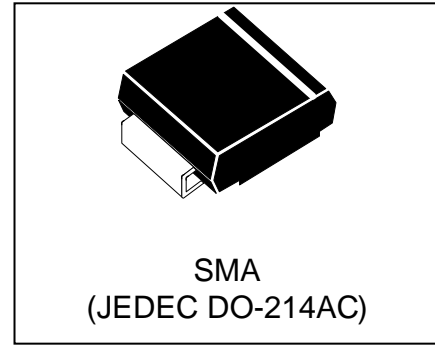

Mechanical Characteristics

- JEDEC DO-214AC(SMAJ) package
- Molding compound flammability rating:
UL 94V-0
- Marking : Marking Code
- Packaging : Tape and Reel per EIA 481
- RoHS/WEEE Compliant

Applications

- I/O Interfaces
- Power lines
- Automotive and Telecommunication
- Computers & Consumer Electronics
- Industrial Electronics

Absolute Maximum Rating			
Rating	Symbol	Value	Units
Peak Pulse Power (tp =10/1000 μ s) (see Note1,2& 3)	P _{PPM}	400	Watts
Peak pulse current (10/1000 μ s) (see Note2&3)	I _{PPM}	See Electrical Characteristics	A
Peak Forward surge current (see Note4&5)	I _{FSM}	40	A
Power Dissipation on infinite heat sink T _A = 50 °C (Fig5)	P _D	1.0	W
Operating Junction Temperature range	T _J	-65 to + 150	°C
Storage Temperature range	T _{STG}	-65 to + 150	°C

Note1: Peak Pulse Power Rating as Pulse Width ,per Fig1.

Note2: Peak Pusle Power or Current Derated above T_A=25°C Per Fig. 2 and Non-Repetitive Current Pulse,Per Fig.3.

Note3: Mounted on 5.0x5.0mm² copper pad to each terminal.

Note4: 8.3ms Single Half Sine Wave or Equivalent Square Wave.

Note5: Maximum Forward Surge Current only for Unidirectional Device per Fig6.

Electrical Characteristics

Part Number		Reverse Stand off Voltage V_{RWM} (Volts)	Breakdown Voltage		Test Current I_T (mA)	Maximum Clamping Voltage $V_C@I_{PP}$ (Volts)	Maximum PeakPulse Current I_{pp} (Amps)	Maximum Reverse Leakage $I_R@V_{RWM}$ (μ A)
			$V_{BR}(\text{Volts})@I_T$					
UNI-POLAR	BI-POLAR		MIN	MAX				
SMAJ5.0A	SMAJ5.0CA	5.0	6.40	7.07	10	9.2	43.5	800
SMAJ6.0A	SMAJ6.0CA	6.0	6.67	7.37	10	10.3	38.8	800
SMAJ6.5A	SMAJ6.5CA	6.5	7.22	7.98	10	11.2	35.7	500
SMAJ7.0A	SMAJ7.0CA	7.0	7.78	8.60	10	12.0	33.3	200
SMAJ7.5A	SMAJ7.5CA	7.5	8.33	9.21	1	12.9	31.0	100
SMAJ8.0A	SMAJ8.0CA	8.0	8.89	9.83	1	13.6	29.4	50
SMAJ8.5A	SMAJ8.5CA	8.5	9.44	10.40	1	14.4	27.8	20
SMAJ9.0A	SMAJ9.0CA	9.0	10.00	11.10	1	15.4	26.0	10
SMAJ10A	SMAJ10CA	10	11.10	12.30	1	17.0	23.5	5
SMAJ11A	SMAJ11CA	11	12.20	13.50	1	18.2	22.0	5
SMAJ12A	SMAJ12CA	12	13.30	14.7	1	19.9	20.1	5
SMAJ13A	SMAJ13CA	13	14.40	15.90	1	21.5	18.6	1
SMAJ14A	SMAJ14CA	14	15.60	17.20	1	23.2	17.2	1
SMAJ15A	SMAJ15CA	15	16.70	18.50	1	24.4	16.4	1
SMAJ16A	SMAJ16CA	16	17.80	19.70	1	26.0	15.4	1
SMAJ17A	SMAJ17CA	17	18.90	20.90	1	27.6	14.5	1
SMAJ18A	SMAJ18CA	18	20.00	22.10	1	29.2	13.7	1
SMAJ20A	SMAJ20CA	20	22.20	24.50	1	32.4	12.3	1
SMAJ22A	SMAJ22CA	22	24.40	26.90	1	35.5	11.3	1
SMAJ24A	SMAJ24CA	24	26.70	29.50	1	38.9	10.3	1
SMAJ26A	SMAJ26CA	26	28.90	31.90	1	42.1	9.5	1
SMAJ28A	SMAJ28CA	28	31.10	34.40	1	45.4	8.8	1
SMAJ30A	SMAJ30CA	30	33.30	36.80	1	48.4	8.3	1
SMAJ33A	SMAJ33CA	33	36.70	40.60	1	53.3	7.5	1
SMAJ36A	SMAJ36CA	36	40.00	44.20	1	58.1	6.9	1
SMAJ40A	SMAJ40CA	40	44.40	49.10	1	64.5	6.2	1

Electrical Characteristics (Cont.)

Part Number		Reverse Stand off Voltage V_{RWM} (Volts)	Breakdown Voltage $V_{BR}(\text{Volts})@I_T$		Test Current I_T (mA)	Maximum Clamping Voltage $V_c@I_{PP}$ (Volts)	Maximum PeakPulse Current I_{pp} (Amps)	Maximum Reverse Leakage $I_R@V_{RWM}$ (μA)
			MIN	MAX				
UNI-POLAR	BI-POLAR							
SMAJ43A	SMAJ43CA	43	47.80	52.80	1	69.4	5.8	1
SMAJ45A	SMAJ45CA	45	50.00	55.30	1	72.7	5.5	1
SMAJ48A	SMAJ48CA	48	53.30	58.90	1	77.4	5.2	1
SMAJ51A	SMAJ51CA	51	56.70	62.70	1	82.4	4.9	1
SMAJ54A	SMAJ54CA	54	60.00	66.30	1	87.1	4.6	1
SMAJ58A	SMAJ58CA	58	64.40	71.20	1	93.6	4.3	1
SMAJ60A	SMAJ60CA	60	66.70	73.70	1	96.8	4.1	1
SMAJ64A	SMAJ64CA	64	71.10	78.60	1	103	3.9	1
SMAJ70A	SMAJ70CA	70	77.80	86.00	1	113	3.5	1
SMAJ75A	SMAJ75CA	75	83.30	92.10	1	121	3.3	1
SMAJ78A	SMAJ78CA	78	86.70	95.80	1	126	3.2	1
SMAJ85A	SMAJ85CA	85	94.40	104	1	137	2.9	1
SMAJ90A	SMAJ90CA	90	100	111	1	146	2.7	1
SMAJ100A	SMAJ100CA	100	111	123	1	162	2.5	1
SMAJ110A	SMAJ110CA	110	122	135	1	177	2.3	1
SMAJ120A	SMAJ120CA	120	133	147	1	193	2.0	1
SMAJ130A	SMAJ130CA	130	144	159	1	209	1.9	1
SMAJ150A	SMAJ150CA	150	167	185	1	243	1.6	1
SMAJ160A	SMAJ160CA	160	178	197	1	259	1.5	1
SMAJ170A	SMAJ170CA	170	189	209	1	275	1.4	1
SMAJ188A	SMAJ188CA	188	209	231	1	328	1.2	1

Typical Characteristics

Figure 1: Peak Pulse Power Rating Curve

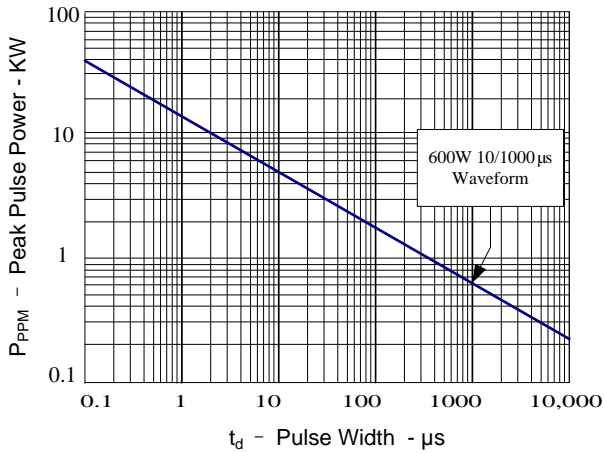

Figure 2: Pulse Derating Curve

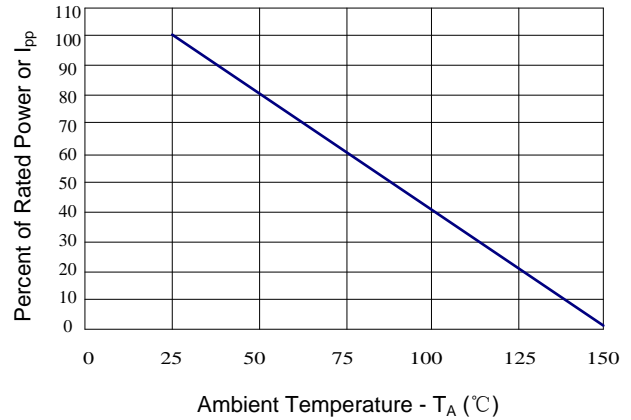

Figure 3: Pulse Waveform

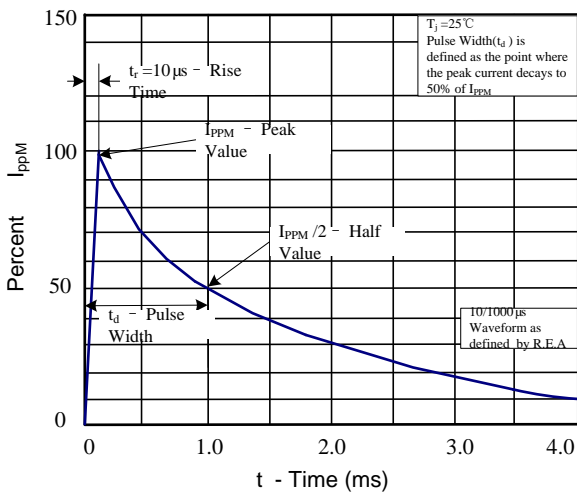

Figure 4: Typical Junction Capacitance

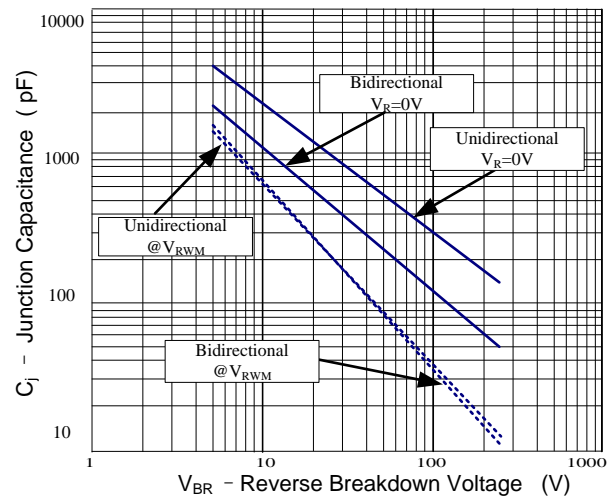

Figure 5: Steady State Power Dissipation Derating Curve

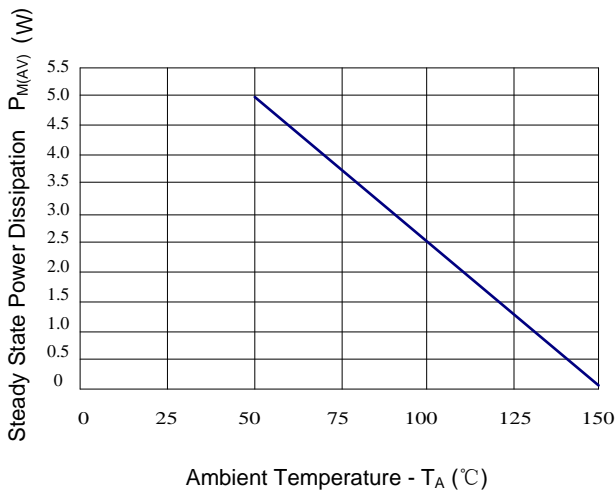
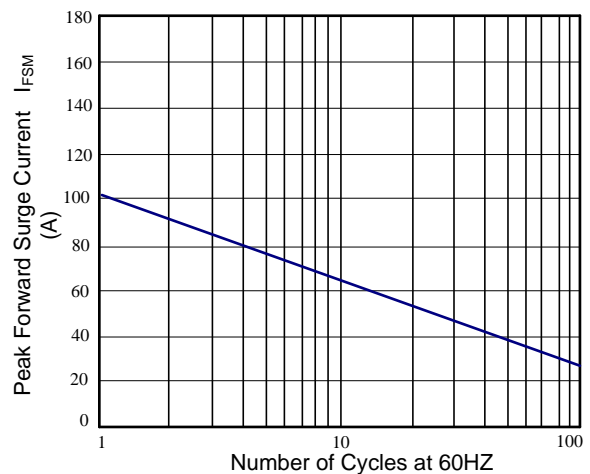

Figure 6: Maximum Non-Repetitive Forward Surge Current Only Unidirectional



Outline Drawing – SMAJ(DO-214AC)

Ref. (mm)	Millimeters	
	Min.	Max.
A	1.980	2.290
A1	-	0.203
B	1.250	1.650
E	3.990	4.500
E1	0.152	0.305
D	2.540	2.790
L	0.780	1.520

