

EL CONNECTOR

4.5mm pitch/Disconnectable Crimp style Wire-to-wire connectors

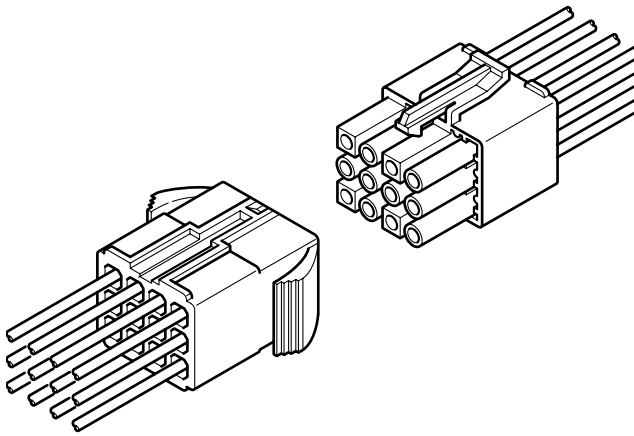

The contacts for the compact EL connector can be easily inserted into the connector housings. The plug housing and the receptacle housing can be smoothly mated even if they are mechanically distorted.

- Easy insertion and secure installation of contacts
- A smooth connection even when pried during mating
- Durable arm lock mechanism
- Two contact styles
- Interchangeability with ML connector

Specifications

- Current rating: 10A AC, DC max.
- Voltage rating: 300V AC, DC max.
- Temperature range: -25°C to +90°C (including temperature rise in applying electrical current)
- Contact resistance: Initial value/7m Ω max. After environmental testing/10m Ω max.
- Insulation resistance: 1,000M Ω min.
- Withstanding voltage: 1,500V AC/minute
- Applicable wire: AWG #26 to #16 0.13 to 1.25mm²
- Applicable panel thickness: 0.8 to 2.0mm
- * Compliant with RoHS.
- * Refer to "General Instruction and Notice when using Terminals and Connectors" at the end of this catalog.
- * Contact JST for details.

Note: The current rating varies depending on the number of circuits and the wire size used in each connector. The table below lists the current rating as a function of the number of circuits and the wire size.

Current unit : A

Circuits	Wire size (AWG)					
	#16	#18	#20	#22	#24	#26
2	10	6	5	4	4	3
3	10	6	5	4	4	3
4	10	6	5	4	4	3
6	8	5	4	3	3	3
9	6	4	3	3	2	2
12	6	4	3	3	2	2
15	6	4	3	3	2	2

Standards

Recognized E60389

Certified LR20812

R75052

Panel layout and Assembly layout

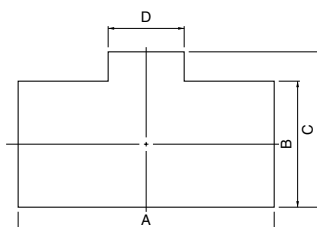
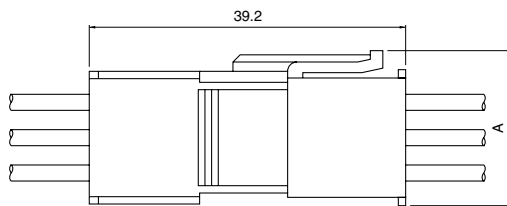

Circuits	Dimensions A (mm)
2~4 (Single-line arrangement)	10.4
4 (Double-line arrangement)	15.0
6	14.9
9~15	19.4

Circuits	Receptacle housing Model No.	Panel hole dimensions (mm)				Applicable panel thickness (mm)
		A	B	C	D	
2	ELR-02V	15.0	6.0	6.85	5.2	0.8~2.0
3	ELR-03V	19.7	6.0	6.85	5.2	
4	ELR-04V	24.2	6.0	6.85	5.2	
	ELR-04NV	15.6	10.6	11.6	5.2	
6	ELR-06V	19.7	10.2	11.1	5.2	
9	ELR-09V	19.7	14.8	15.7	5.2	
12	ELR-12V	24.2	14.8	15.7	5.2	
15	ELR-15V	28.7	14.8	15.7	5.2	

- Note: 1. Punch holes in the panel according to the figures and table shown above. Burrs must be removed.
 2. The strength of the panel must be considered when punching two or more holes.
 3. The connector must be inserted from the same side as the hole is punched.

EL CONNECTOR

Contact

Pin contact

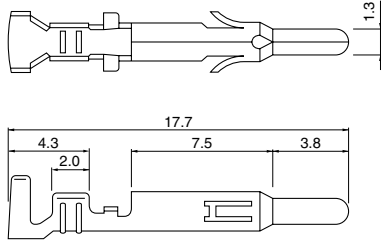

Socket contact

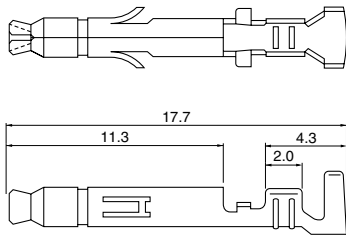

Model No.		Applicable wire		Insulation O.D. (mm)	Q'ty / reel
Pin contact	Socket contact	mm ²	AWG #		
SLM-01T-P1.3E	SLF-01T-P1.3E	0.13~0.5	26~20	1.3~2.7	6,000
SLM-41T-P1.3E	SLF-41T-P1.3E	0.5 ~1.25	20~16	1.9~3.4	4,000
*SLM-42T-P1.3E	*SLF-42T-P1.3E	0.3+0.3~ 0.5+0.5	22+22~ 20+20	1.7+1.7~ 2.0+2.0	

Material and Finish

Phosphor bronze, tin-plated (reflow treatment)

RoHS compliance

- Note: 1. Contact denoted by * is used for two wires.
 2. Contact JST for special products.
 3. Contact JST for brass products.

Contact	Crimping machine	Applicator		
		Crimp applicator	Dies	Crimp applicator with dies
SLM-01T-P1.3E	AP-K2N	MKS-L	MK/SLF/M-01-13E	APLMK SLF/M01-13E
SLF-01T-P1.3E		*MKS-SC	SC/SLF/M-01-13E	APLSC SLF/M01-13E
SLM-42T-P1.3E		MKS-L	MK/SLF/M-42-13E	APLMK SLF/M42-13E
SLF-42T-P1.3E		—	—	—
SLM-41T-P1.3E		MKS-L	MK/SLF/M-41-13E	APLMK SLF/M41-13E
SLF-41T-P1.3E		*MKS-SC	SC/SLF/M-41-13E	APLSC SLF/M41-13E

Note: *Strip-crimp applicator

Contact position location numbers

Contact position numbers are stamped

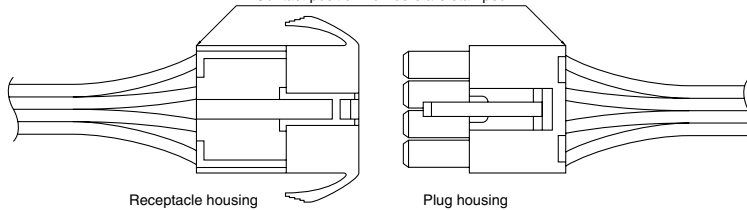

Receptacle housing

Plug housing

Receptacle housing

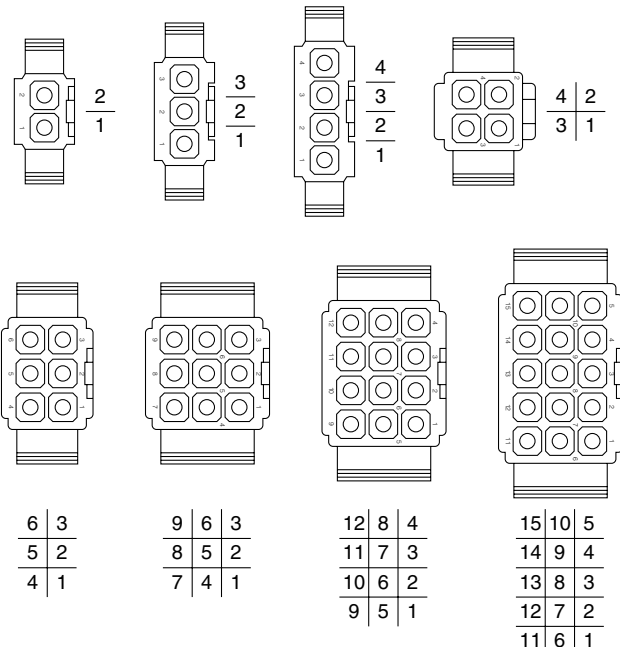



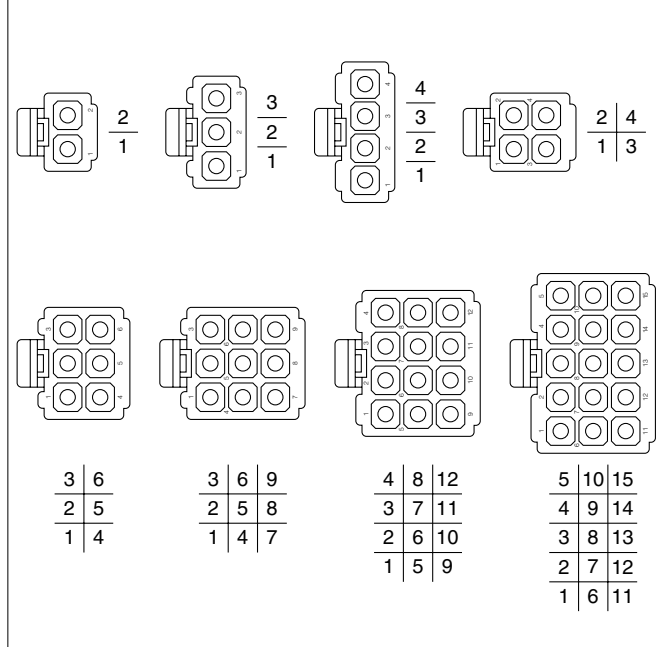

Plug housing

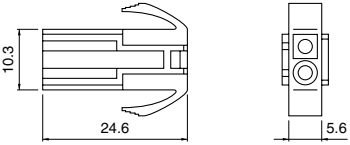

EL CONNECTOR

Housing

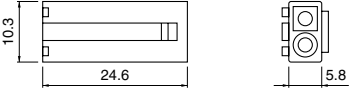
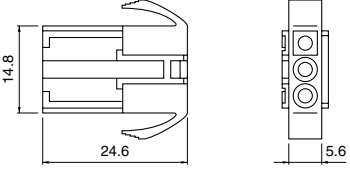
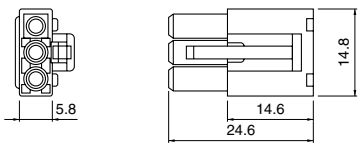
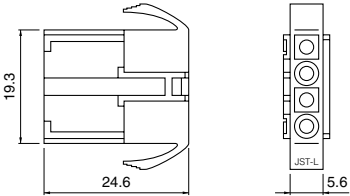
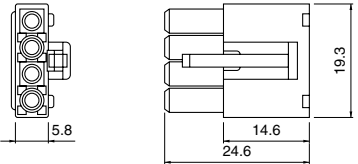
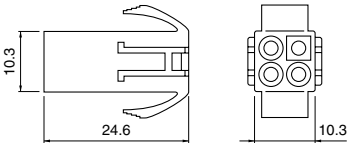
Material: PA 6, UL94V-0, white

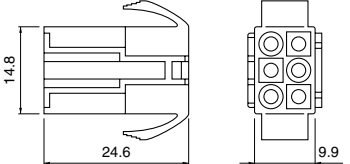
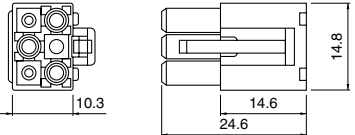
Circuits	Voltage rating	Current rating	Receptacle housing(for pin contact)		Plug housing(for socket contact)	
2	300V	10A	ELR-02V 	Q'ty / bag 500	ELP-02V 	Q'ty / bag 500
			ELR-02VF 	Q'ty / bag 500		
3	300V	10A	ELR-03V 	Q'ty / bag 500	ELP-03V 	Q'ty / bag 500
4	300V	10A	ELR-04V 	Q'ty / bag 500	ELP-04V 	Q'ty / bag 500
			ELR-04NV 	Q'ty / bag 500		
			ELR-04NVF 			
6	300V	8A	ELR-06V 	Q'ty / bag 500	ELP-06V 	Q'ty / bag 500

RoHS compliance

EL CONNECTOR

Housing

Material: PA 6, UL94V-0, white

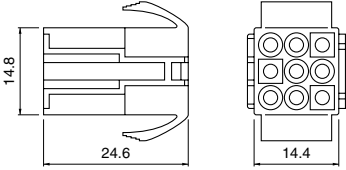
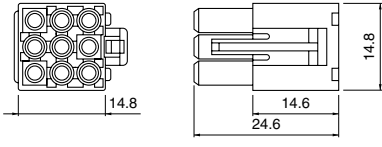
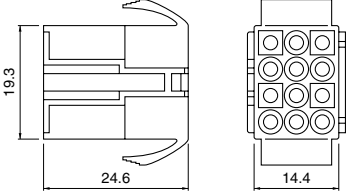
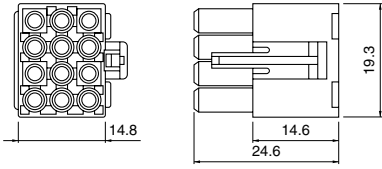
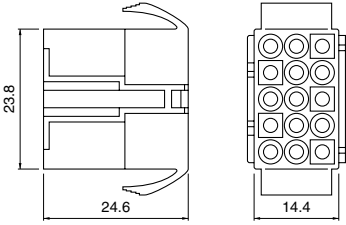
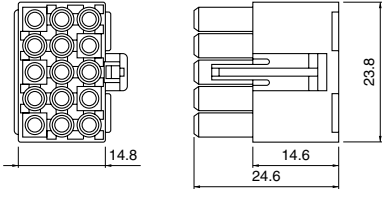
Circuits	Voltage rating	Current rating	Receptacle housing(for pin contact)		Plug housing(for socket contact)	
9	300V	6A	ELR-09V 	Q'ty / bag 500	ELP-09V 	Q'ty / bag 500
12	300V	6A	ELR-12V 	Q'ty / bag 500	ELP-12V 	Q'ty / bag 500
15	300V	6A	ELR-15V 	Q'ty / bag 500	ELP-15V 	Q'ty / bag 500

RoHS compliance

Note: 1. ELR-02VF and ELR-04NVF are exclusively for free hanging. The other circuits can be used either for panel mounted or free hanging.

See "Panel layout" for the panel hole dimensions.

2. Contact JST for special products.