









32.768kHz Series Tuning Fork Crystal Units

The 32.768kHz tuning fork crystal unit is the most widely used frequency control product. TAITIEN's tuning-fork-type crystals have low power consumption ideal for portable application. Their different package sizes provide the customers more choices for time management. TAITIEN's tuning-fork-type crystals are cost effective real time clock products.

| Type | XA | XB | | XD | | | XN | |
|-----------|--|---|---|---|---|---|--|--|
| Size (mm) | 3 x 8 | 1 x 4 | 2 x 6 | 2.0 x 1.2 | 3.2 x 1.5 | 4.1 x 1.5 | 6.9 x 1.4 | 8.0 x 3.8 |
| Package | DIP | DIP | DIP | SMD | SMD | SMD | SMD | SMD |
| RoHS | Yes | Yes | Yes | Yes | Yes | Yes | Yes* | Yes* |
| Outline |  |  |  |  |  |  |  |  |

* Pb in high temperature solder (exempt per RoHS 2002/95/EC Annex (7)) and suitable for RoHS compliant reflow

ELECTRICAL SPECIFICATION

| | |
|---|--------------------------------------|
| Nominal Frequency | 32.768000 kHz |
| Mode of Vibration | Fundamental |
| Storage Temp. Range (T _{STR}) | -55°C ~+125 °C |
| Turnover Temperature (TM) | 25±5 °C |
| Temperature Coefficient (β) | -(0.03±0.01) ppm/°C ² |
| Frequency vs. Temperature (Δf / fM) | β × (T-TM) ² ppm |
| Series Resistance (R1) | 65~90 KΩ Max. |
| Level of Drive (DL) | 0.1±0.01 uW Typ, 0.5 uW Max. |
| Aging (first year) (Δf / f0) | ±3 ppm Max. |
| Quality Factor (Q) | 30000~60000 Typ. |
| Shunt Capacitance (C0) | 3~7 pF Max. |
| Load Capacitance (CL) | 6, 7, 9, 12.5 pF (Please contact us) |
| Frequency Tolerance(f _{tol}) | ±20 ppm @ 25±5 °C |
| Insulation Resistance | 500 MΩ Min. @ DC 100±15 V |

Specifications subject to change without notice

FREQ. vs. CAPACITANCE RATIO (C0/C1)

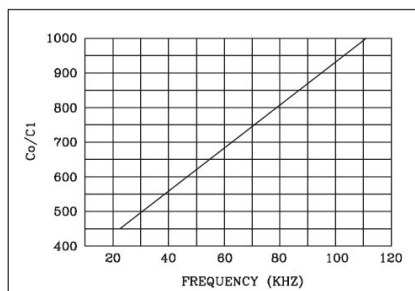

FREQ. vs. LOAD CAPACITANCE (TYP.)

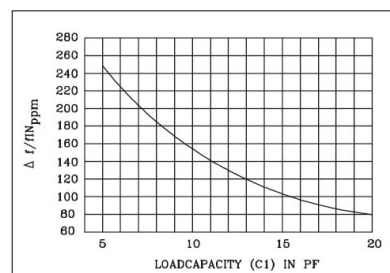

FREQ. vs. TEMPERATURE (TYP.)

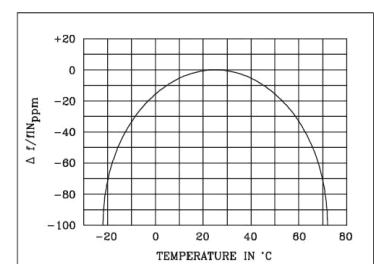

Rev(3)06/2016

DIMENSION (mm) – XA / XB Type

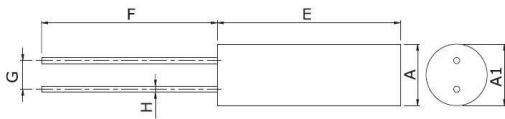

UNIT:mm

| TYPE | A | A' | E | F | G | H |
|------|-----|--------|--------|--------|----------|------------|
| XA | 3.0 | 3.1max | 8.0max | 10±1 | 0.8±0.2 | ∅0.32±0.07 |
| XB-N | 2.0 | 2.1max | 6.0max | 5.0min | 0.7±0.2 | ∅0.28±0.05 |
| XB-J | 1.0 | 1.2max | 4.6max | 5.7min | 0.3±0.05 | ∅0.18±0.03 |

DIMENSION (mm) – XD Type

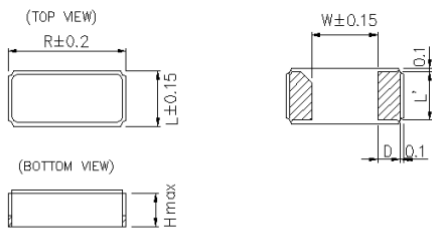

| Model | R | L | H | W | L' | D | S | P | ∠L' |
|-------|-----|-----|-----|-----|-----|-----|-----|-----|-----|
| 4115 | 4.1 | 1.5 | 0.9 | 2.7 | 1.3 | 0.6 | 3.4 | 1.1 | 1.8 |
| 3215 | 3.2 | 1.5 | 0.9 | 1.7 | 1.3 | 0.6 | 2.5 | 1.1 | 1.8 |
| 2012 | 2.0 | 1.2 | 0.6 | 0.8 | 1.0 | 0.5 | 1.4 | 0.6 | 1.1 |

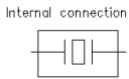

SOLDER PAD LAYOUT (mm)

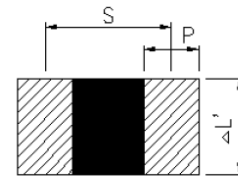

Do not design any patterns on shaded area
 Recommended soldering pattern

DIMENSION (mm) – XN Type

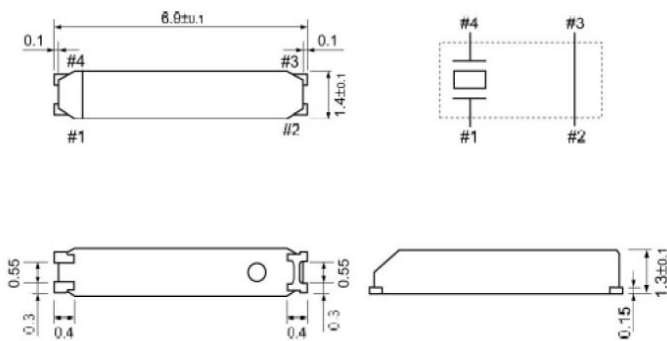

* Do not connect to external with #2 and #3

SOLDER PAD LAYOUT (mm)

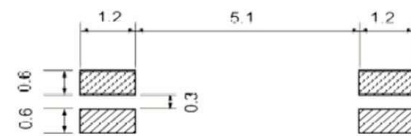

DIMENSION (mm) – XN Type

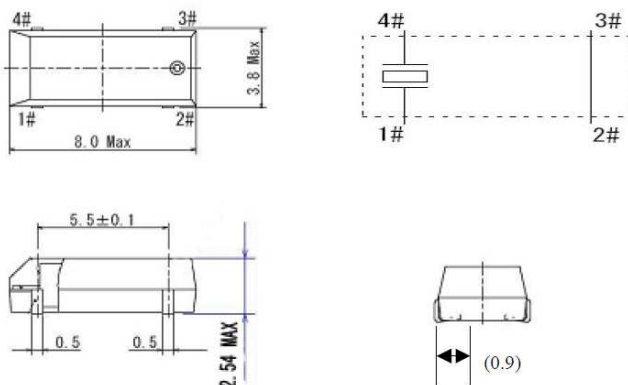

SOLDER PAD LAYOUT (mm)

