

## SOP8 Plastic-Encapsulate MOSFETS

### CJQ4435S P-Channel Power MOSFET

$V_{(BR)DSS}$	$R_{DS(on)}$ TYP	$I_D$
-30V	18mΩ@-10V	-7.3A
	26mΩ@ -4.5V	

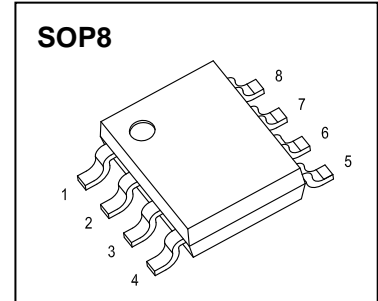

#### DESCRIPTION

The CJQ4435S uses advanced trench technology to provide excellent  $R_{DS(on)}$ , shoot-through immunity, body diode characteristics and ultra-low gate resistance. This device is ideally suited for use as a low side switch in Notebook CPU core power conversion.

#### APPLICATIONS

- Battery Switch
- Load Switch

#### MARKING



Q4435S= Device code  
 Solid dot=Pin1 indicator  
 Solid dot = Green molding compound device,  
 if none, the normal device  
 YY=Date Code

#### Equivalent Circuit

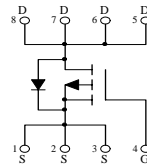

#### MAXIMUM RATINGS ( $T_a=25^\circ\text{C}$ unless otherwise noted )

Parameter	Symbol	Limit	Unit
Drain-Source Voltage	$V_{DS}$	-30	V
Gate-Source Voltage	$V_{GS}$	$\pm 20$	V
Continuous Drain Current	$I_D$	-7.3	A
Pulsed Drain Current	$I_{DM}$	-27	A
Single Pulsed Avalanche Energy	$E_{AS}^{(1)}$	20	mJ
Power Dissipation	$P_D$	1.4	W
Thermal Resistance from Junction to Ambient	$R_{\theta JA}$	89	$^\circ\text{C/W}$
Junction Temperature	$T_J$	150	$^\circ\text{C}$
Storage Temperature Range	$T_{stg}$	-55 ~ +150	$^\circ\text{C}$

(1).  $E_{AS}$  condition:  $V_{DD}=-20V, L=0.5mH, R_G=25\Omega$ , Starting  $T_J = 25^\circ\text{C}$

# MOSFET ELECTRICAL CHARACTERISTICS

$T_a=25\text{ }^\circ\text{C}$  unless otherwise specified

Parameter	Symbol	Test Condition	Min	Typ	Max	Unit
<b>Off characteristics</b>						
Drain-source breakdown voltage	$V_{(BR)DSS}$	$V_{GS} = 0V, I_D = -250\mu A$	-30			V
Zero gate voltage drain current	$I_{DSS}$	$V_{DS} = -30V, V_{GS} = 0V$			-1	$\mu A$
Gate-body leakage current	$I_{GSS}$	$V_{DS} = 0V, V_{GS} = \pm 20V$			$\pm 100$	nA
<b>On characteristics (note1)</b>						
Gate-threshold voltage	$V_{GS(th)}$	$V_{DS} = V_{GS}, I_D = -250\mu A$	-1.0	-1.5	-3.0	V
Static drain-source on-state resistance	$R_{DS(on)}$	$V_{GS} = -10V, I_D = -7.3A$		18	24	m $\Omega$
		$V_{GS} = -4.5V, I_D = -6.9A$		26	35	m $\Omega$
Forward transconductance	$g_{fs}$	$V_{DS} = -10V, I_D = -7.3A$		12		S
<b>Dynamic characteristics (note 2)</b>						
Input capacitance	$C_{iss}$	$V_{DS} = -15V, V_{GS} = 0V,$ $f = 1MHz$		1400		pF
Output capacitance	$C_{oss}$			165		
Reverse transfer capacitance	$C_{rss}$			145		
<b>Switching characteristics (note 2)</b>						
Total gate charge	$Q_g$	$V_{DS} = -15V, V_{GS} = -10V,$ $I_D = -7.3A$			42	nC
		$V_{DS} = -15V, V_{GS} = -4.5V,$ $I_D = -7.3A$			25	
Gate-source charge	$Q_{gs}$				7	
Gate-drain charge	$Q_{gd}$				12	
Turn-on delay time	$t_{d(on)}$	$V_{DD} = -15V, I_D = -1A,$ $V_{GS} = -10V, R_G = 1\Omega,$ $R_L = 15\Omega$			15	ns
Turn-on rise time	$t_r$				15	
Turn-off delay time	$t_{d(off)}$				70	
Turn-off fall time	$t_f$				25	
<b>Drain-Source Diode Characteristics</b>						
Drain-source diode forward voltage(note1)	$V_{SD}$	$V_{GS} = 0V, I_S = -2A$			-1.2	V
Continuous drain-source diode forward current	$I_S$				-7.3	A
Pulsed drain-source diode forward current	$I_{SM}$				-27	A

Notes:

1. Pulse Test : Pulse Width  $\leq 300\mu s$ , duty cycle  $\leq 2\%$ .
2. Guaranteed by design, not subject to production testing.

# TYPICAL CHARACTERISTICS

Output Characteristics

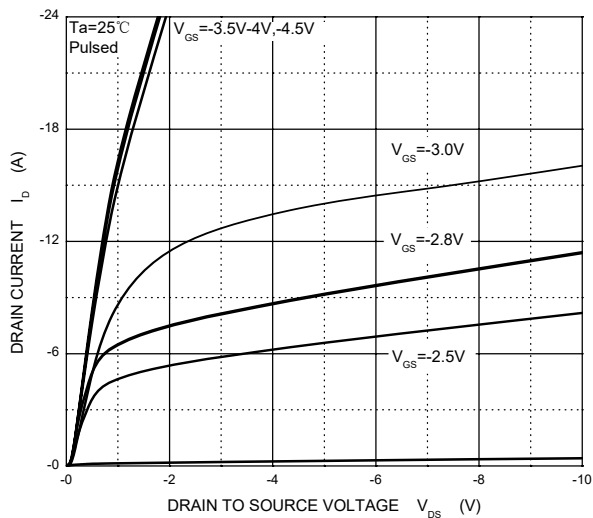

Transfer Characteristics

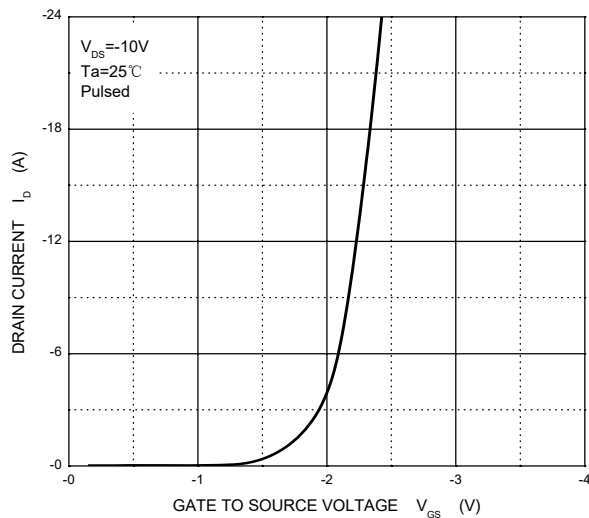

$R_{DS(ON)}$  —  $I_d$

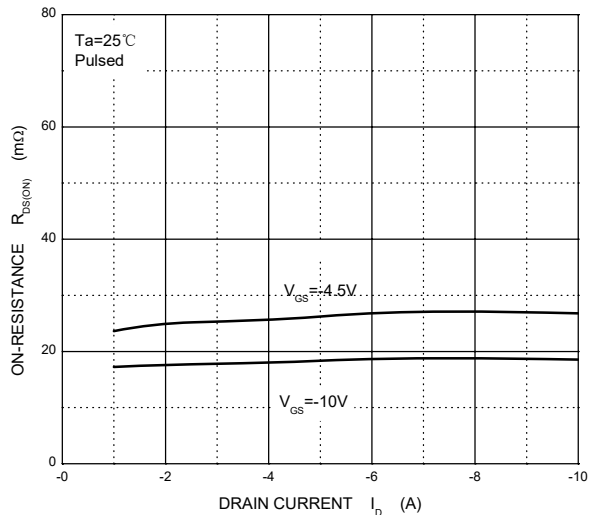

$R_{DS(ON)}$  —  $V_{GS}$

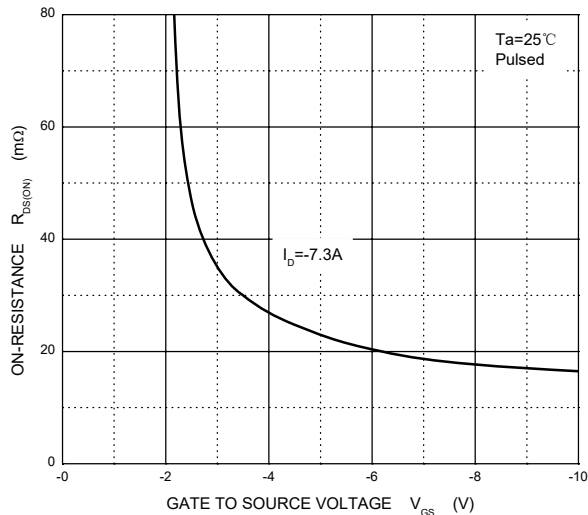

Threshold Voltage

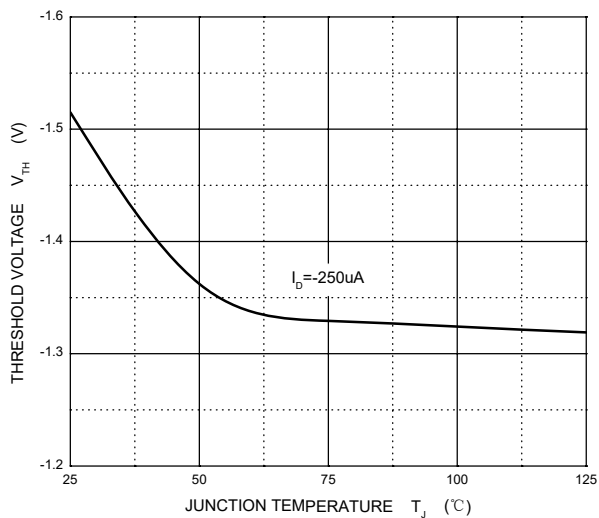

$I_s$  —  $V_{SD}$

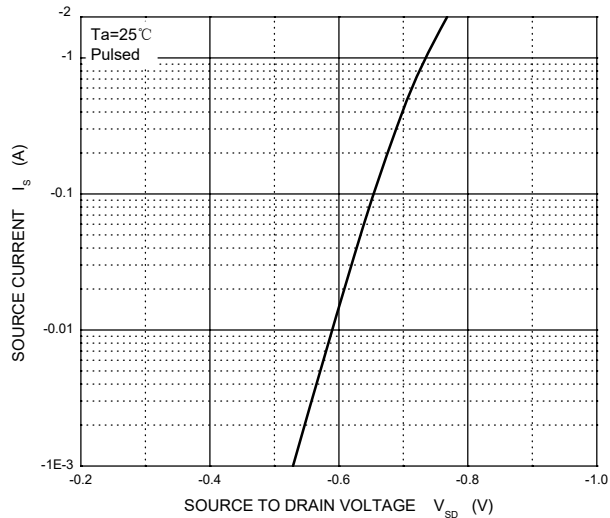

## SOP8 Package Outline Dimensions

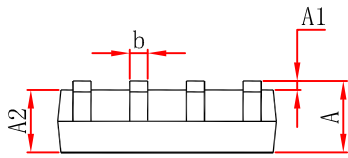
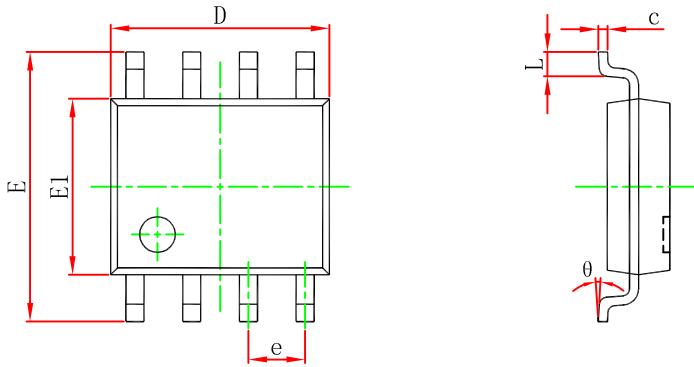

Symbol	Dimensions In Millimeters		Dimensions In Inches	
	Min	Max	Min	Max
A	1.350	1.750	0.053	0.069
A1	0.100	0.250	0.004	0.010
A2	1.350	1.550	0.053	0.061
b	0.330	0.510	0.013	0.020
c	0.170	0.250	0.007	0.010
D	4.800	5.000	0.189	0.197
e	1.270 (BSC)		0.050 (BSC)	
E	5.800	6.200	0.228	0.244
E1	3.800	4.000	0.150	0.157
L	0.400	1.270	0.016	0.050
theta	0°	8°	0°	8°

## SOP8 Suggested Pad Layout

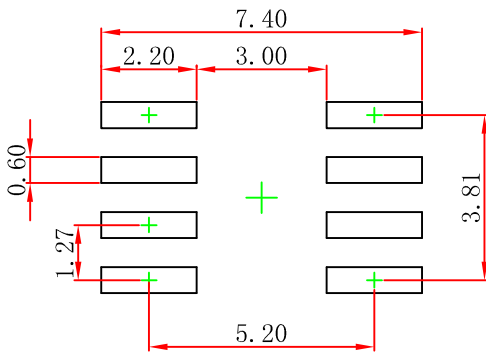

- Note:
1. Controlling dimension: in millimeters.
  2. General tolerance:  $\pm 0.05\text{mm}$ .
  3. The pad layout is for reference purposes only.

### NOTICE

JSCJ reserves the right to make modifications, enhancements, improvements, corrections or other changes without further notice to any product herein. JSCJ does not assume any liability arising out of the application or use of any product described herein.

# SOP8 Tape and Reel

## SOP8 Embossed Carrier Tape

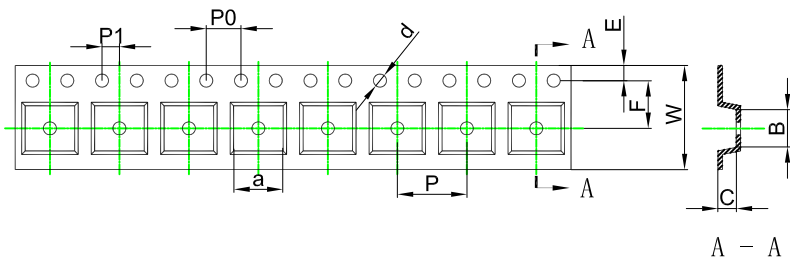

### Packaging Description:

SOP8 parts are shipped in tape. The carrier tape is made from a dissipative (carbon filled) polycarbonate resin. The cover tape is a multilayer film (Heat Activated Adhesive in nature) primarily composed of polyester film, adhesive layer, sealant, and anti-static sprayed agent. These reeled parts in standard option are shipped with 2,500 units per 13" or 33cm diameter reel. The reels are clear in color and is made of polystyrene plastic (anti-static coated).

ALL DIM IN mm

Dimensions are in millimeter										
Pkg type	a	B	C	d	E	F	P0	P	P1	W
SOP8	6.40	5.40	2.10	Ø1.50	1.75	5.50	4.00	8.00	2.00	12.00

## SOP8 Tape Leader and Trailer

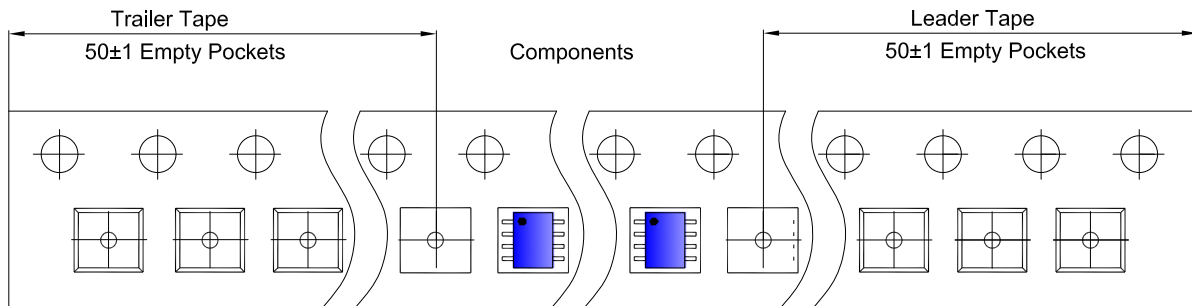

## SOP8 Reel

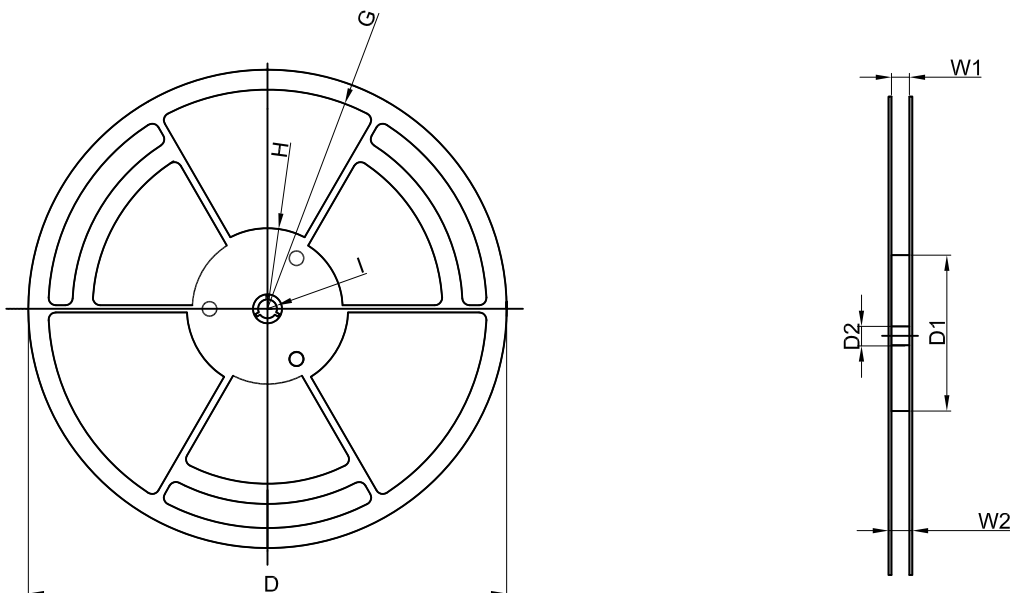

Dimensions are in millimeter								
Reel Option	D	D1	D2	G	H	I	W1	W2
13" Dia	Ø330.00	100.00	13.00	R151.00	R56.00	R6.50	12.40	17.60

REEL	Reel Size	Box	Box Size(mm)	Carton	Carton Size(mm)	G.W.(kg)
4,000 pcs	13 inch	8,000 pcs	360×360×65	64,000 pcs	565×380×390	