

SOT-23 Plastic-Encapsulate MOSFET

N-Channel MOSFET

Product Summary

$V_{(BR)DSS}$	$R_{DS(on)MAX}$	I_D
20V	31.8mΩ@4.5V	5A
	35.6mΩ@2.5V	
	41.4mΩ@1.8V	

Features

- TrenchFET Power MOSFET
- Excellent $R_{DS(on)}$ and Low Gate Charge

Applications

- DC/DC Converters
- Load Switching for Portable Applications

Marking:

- S12

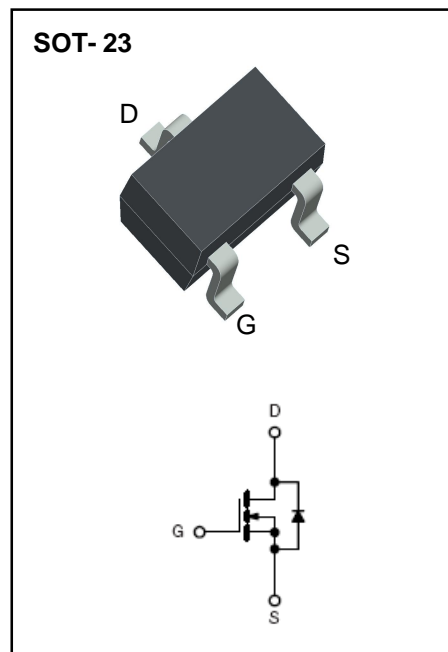

Limiting Values (Absolute Maximum Rating)

Parameter	Symbol	Value	Unit
Drain-Source Voltage	V_{DS}	20	V
Gate-Source Voltage	V_{GS}	±8.0	
Continuous Drain Current	I_D	5	A
Pulsed Drain Current	I_{DM}	20	
Continuous Source-Drain Diode Current	I_S	1.04	
Maximum Power Dissipation	P_D	0.35	W
Thermal Resistance from Junction to Ambient	$R_{\theta JA}$	357	°C/W
Junction Temperature	T_J	150	°C
Storage Temperature	T_{stg}	-50 ~ +150	

Electrical Characteristics ($T_A=25^\circ\text{C}$ unless otherwise noted)

Parameter	Symbol	Test Condition	Min	Typ	Max	Unit
Static						
Drain-source breakdown voltage	$V_{(BR)DSS}$	$V_{GS} = 0V, I_D = 250\mu A$	20			V
Gate-source leakage	I_{GSS}	$V_{DS} = 0V, V_{GS} = \pm 8V$			± 100	nA
Zero gate voltage drain current	I_{DSS}	$V_{DS} = 20V, V_{GS} = 0V$			1.0	μA
Gate-source threshold voltage	$V_{GS(th)}$	$V_{DS} = V_{GS}, I_D = 250\mu A$	0.45	0.7	1.0	V
Drain-source on-state resistance ^a	$R_{DS(on)}$	$V_{GS} = 4.5V, I_D = 5.0A$		0.018	0.0318	Ω
		$V_{GS} = 2.5V, I_D = 4.7A$		0.023	0.0356	
		$V_{GS} = 1.8V, I_D = 4.3A$		0.030	0.0414	
Forward tranconductance ^a	g_{fs}	$V_{DS} = 10V, I_D = 5.0A$		6		S
Dynamic^b						
Input capacitance	C_{iss}	$V_{DS} = 10V, V_{GS} = 0V, f = 1MHz$		865		pF
Output capacitance	C_{oss}			105		
Reverse transfer capacitance	C_{riss}			55		
Gate resistance	R_g	$f = 1MHz$	0.5		4.8	Ω
Turn-on delay Time	$t_{d(on)}$	$V_{GEN} = 5V, V_{DD} = 10V,$ $I_D = 4A, R_G = 1\Omega, R_L = 2.2\Omega$			10	ns
Rise time	t_r				20	
Turn-off Delay time	$t_{d(off)}$				32	
Fall yime	t_f				12	
Drain-source body diode characteristics						
Forward diode voltage	V_{SD}	$V_{GS} = 0V, I_S = 4A$		0.75	1.2	V

Notes :

- Pulse Test : pulse width $\leq 300\mu s$, duty cycle $\leq 2\%$.
- These parameters have no way to verify.

Typical Characteristics

Output Characteristics

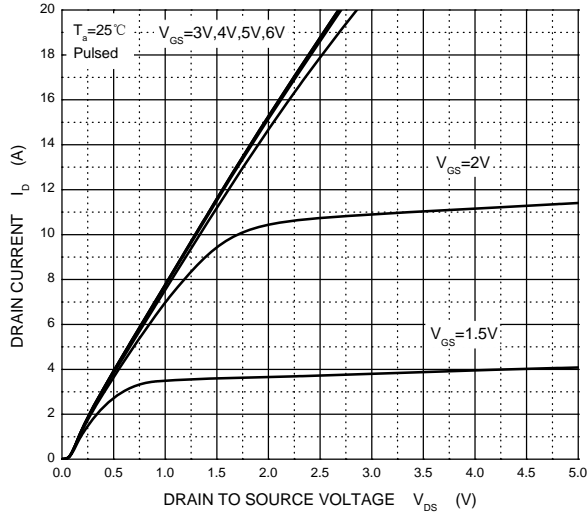

Transfer Characteristics

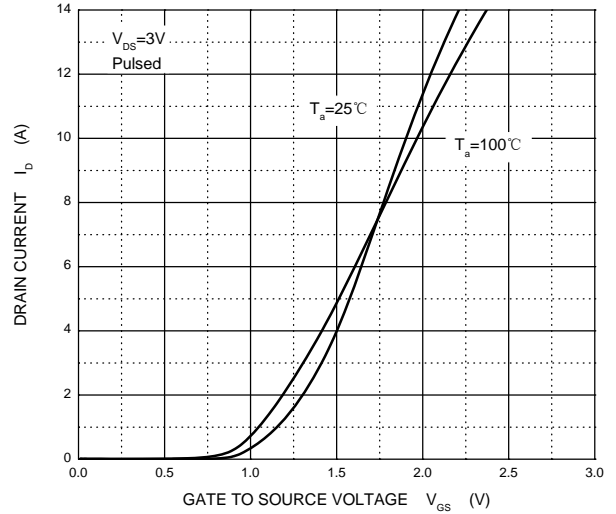

$R_{DS(ON)}$ — I_D

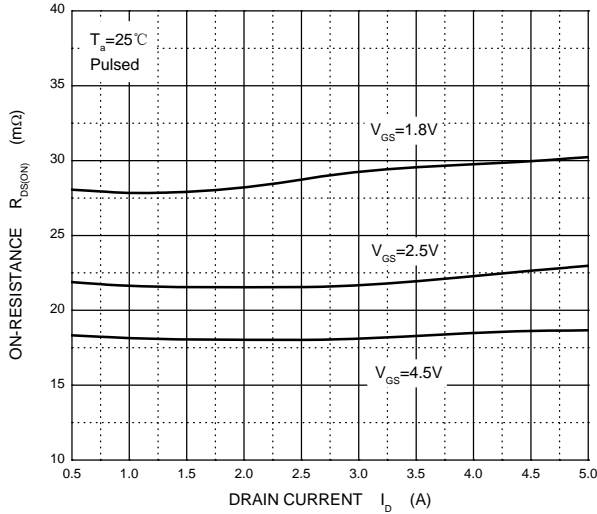

$R_{DS(ON)}$ — V_{GS}

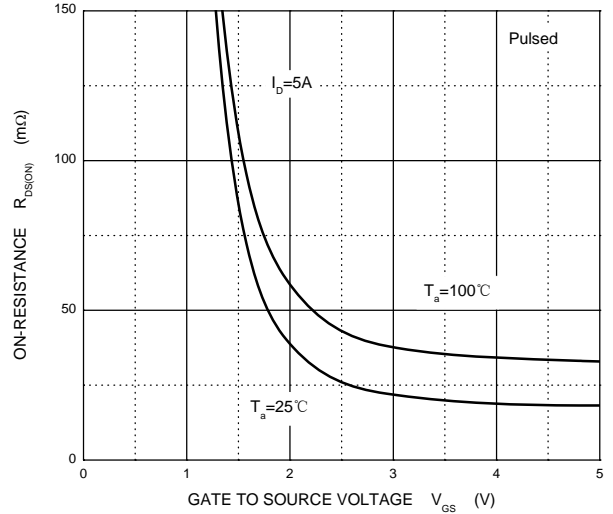

I_S — V_{SD}

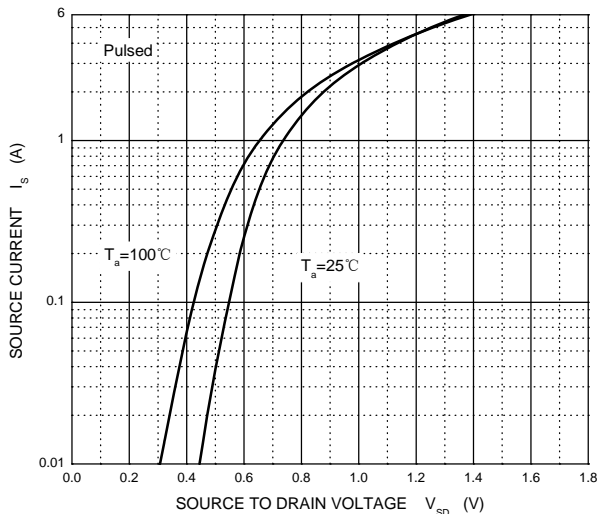

Threshold Voltage

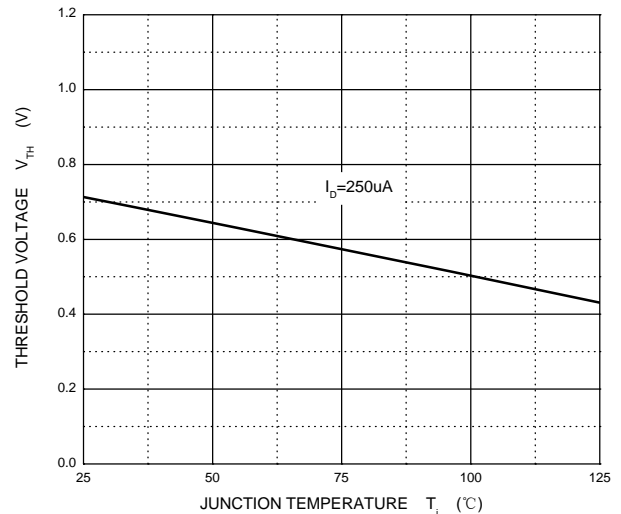

SOT-23 Package Outline Dimensions

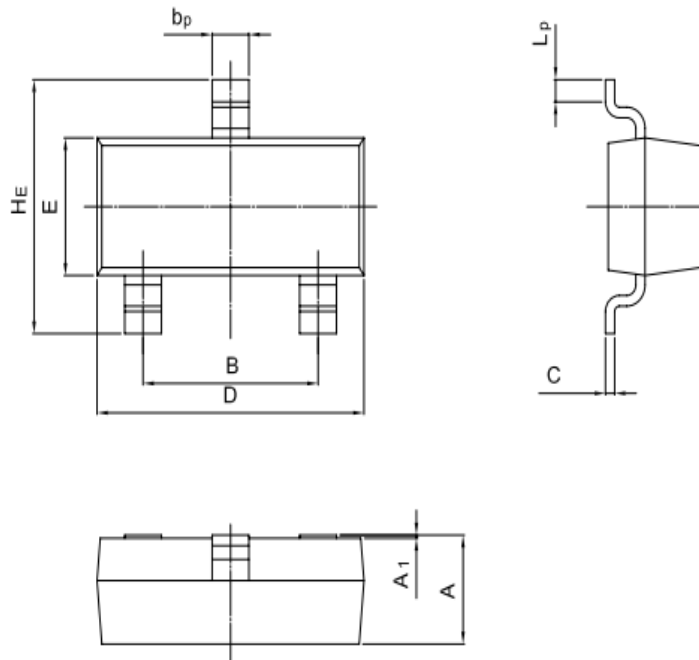

UNIT	A	B	bp	C	D	E	HE	A1	Lp
mm	1.40 0.95	2.04 1.78	0.50 0.35	0.19 0.08	3.10 2.70	1.65 1.20	3.00 2.20	0.100 0.013	0.50 0.20

SOT-23 Suggested Pad Layout

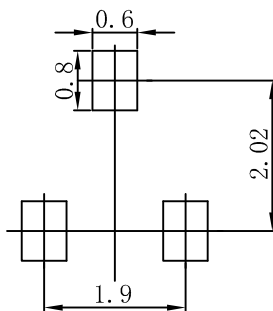

Note:

1. Controlling dimension: in millimeters.
2. General tolerance: $\pm 0.05\text{mm}$.
3. The pad layout is for reference purposes only.

NOTICE

JSKD reserve the right to make modifications, enhancements, improvements, corrections or other changes without further notice to any product herein. JSKD does not assume any liability arising out of the application or use of any product described herein.

Reel Taping Specifications For Surface Mount Devices-SOT-23

SOT-23 Embossed Carrier Tape

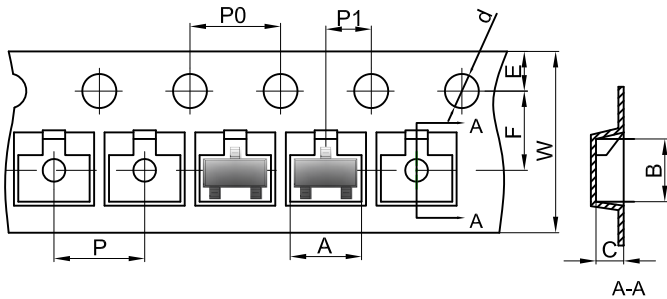

Packaging Description:

SOT-23 parts are shipped in tape. The carrier tape is made from a dissipative (carbon filled) polycarbonate resin. The cover tape is a multilayer film (Heat Activated Adhesive in nature) primarily composed of polyester film, adhesive layer, sealant, and anti-static sprayed agent. These reeled parts in standard option are shipped with 3,000 units per 7" or 17.8cm diameter reel. The reels are clear in color and is made of polystyrene plastic (anti-static coated).

Dimensions are in millimeter										
Pkg type	A	B	C	d	E	F	P0	P	P1	W
SOT-23	3.15	2.77	1.22	Ø1.50	1.75	3.50	4.00	4.00	2.00	8.00

SOT-23 Tape Leader and Trailer

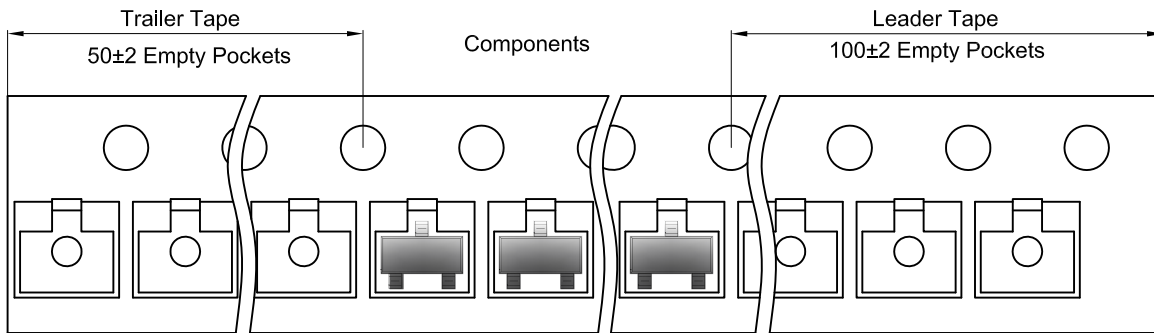

SOT-23 Reel

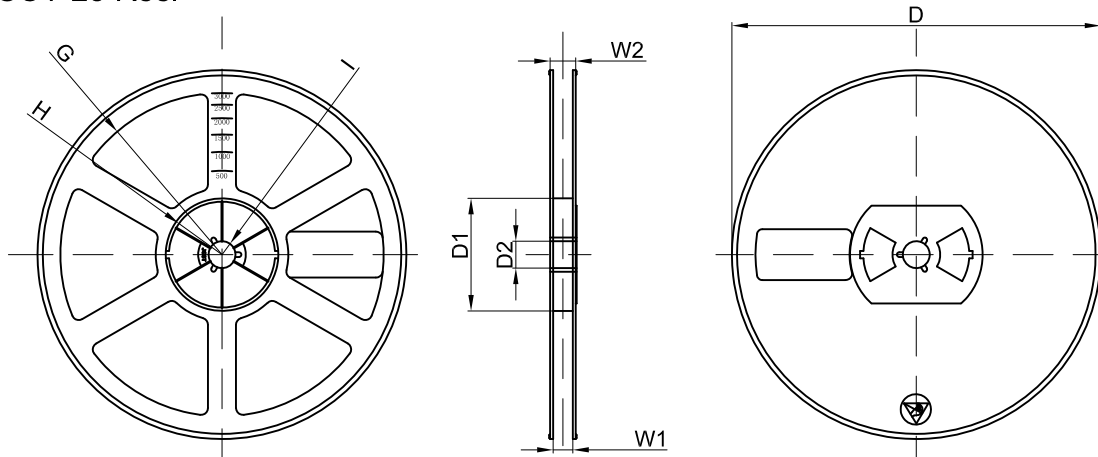

Dimensions are in millimeter								
Reel Option	D	D1	D2	G	H	I	W1	W2
7"Dia	Ø178.00	54.40	13.00	R78.00	R25.60	R6.50	9.50	12.30

REEL	Reel Size	Box	Box Size(mm)	Carton	Carton Size(mm)	G.W.(kg)
3000 pcs	7 inch	45,000 pcs	203×203×195	180,000 pcs	438×438×230	