

P.C.B MOUNTING PATTERN DIMENSION

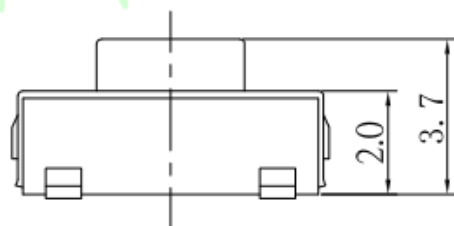

额定负荷 Rating	DC 12V/50mA
接触电阻 Contact Resistance	100mΩ max.
绝缘电阻 Insulation resistance	DC100V 60S 100MΩ min.
抗电强度 Dielectric strength	AC250V(50~60HZ) 60S min.
操作力 Operation force	160±30gf ▶250±50gf
寿命试验 Operating Life	100,000 cycles 70,000 cycles
行程 Travels	0.25±0.1mm

5.0
3.7
3.4
3.1
2.5
高度 G(mm)

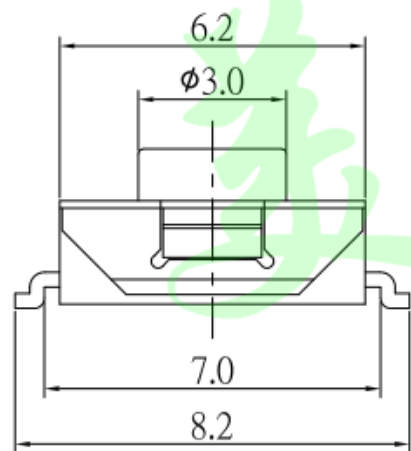
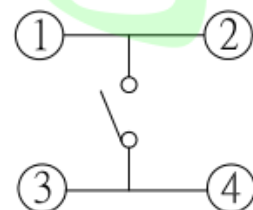

CIRCUIT DIAGRAM

┌	引脚	黄铜	4	镀银
└	弹片	复银铜不锈钢	1	覆银
┌	基座	LCP黑	1	黑色
└	盖板	磷铜0.15	1	镀银
└	按钮	LCP黑	1	黑/红
项目	名称	材质	数量	表面处理

>0.5~2	±0.05	±0.10	±0.15
>2~5	±0.15	±0.20	±0.25
>5~10	±0.25	±0.28	±0.30
角度 ANGLE	±0.5°		
未注尺寸公差 (mm)			

第一视角	设计 Jack Jin	图面 单位 A4	MM
	审核 Jacky Zhong	比例 重量	
	批准 Tony Meng	页码 版次	1/1 A/0

东莞市美韩电子科技有限公司 Dongguan Usakro Electronic Technology Co., Ltd.			
1:1	DWG NO.	型号:UK-B0229-G3.7-B-250	SIZE A4
1 of 1	PART NO.	规格: 6.2*6.2*3.7 4脚黑钮	VER R