

AIMW120R045M1

CoolSiC™ 1200V SiC Trench MOSFET

Silicon Carbide MOSFET

Features

- Revolutionary semiconductor material - Silicon Carbide
- Very low switching losses
- Threshold-free on state characteristic
- IGBT-compatible driving voltage (15V for turn-on)
- 0V turn-off gate voltage
- Benchmark gate threshold voltage, $V_{GS(th)}=4.5V$
- Fully controllable dv/dt
- Commutation robust body diode, ready for synchronous rectification
- Temperature independent turn-off switching losses

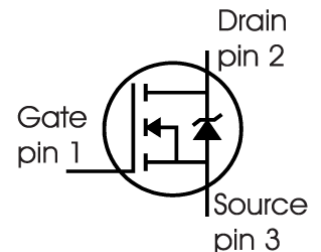

Benefits

- Efficiency improvement
- Enabling higher frequency
- Increased power density
- Cooling effort reduction
- Reduction of system complexity and cost

Potential Applications

- On-board Charger/PFC
- Booster/DC-DC Converter
- Auxilliary Inverter



Product Validation

Qualified for Automotive Applications. Product Validation according to AEC-Q100/101”

Table 1 Key Performance and Package Parameters

Type	V_{DS}	I_D ($T_C=25^\circ C$, $R_{th(j-c,max)}$)	$R_{DS(on),typ}$ ($T_{vj}=25^\circ C$, $I_D=20A$, $V_{GS}=15V$)	T_{vjmax}	Marking	SP Number	Package
AIMW120R045M1	1200V	52A	45m Ω	175 $^\circ C$	A120M1045	SP002472666	PG-TO247-3-41

Table of contents

Features	1
Benefits	1
Potential Applications.....	1
Product Validation.....	1
Table of contents.....	2
1 Maximum ratings	3
2 Thermal resistances	4
3 Electrical Characteristics	5
3.1 Static characteristics.....	5
3.2 Dynamic characteristics.....	6
3.3 Switching characteristics.....	7
4 Electrical characteristic diagrams	8
5 Package drawing	14
6 Test conditions	15
Revision History	16

Maximum ratings

1 Maximum ratings

Stress above the maximum values listed here may cause permanent damage to the device. Exposure to absolute maximum rating conditions for extended periods may affect device reliability.

Table 2 Maximum ratings¹

Parameter	Symbol	Value	Unit
Drain-source voltage, $T_{vj} \geq 25^{\circ}\text{C}$	V_{DSS}	1200	V
DC drain current for $R_{th(j-c,max)}$, limited by $T_{vj,max}$, $V_{GS}=15\text{V}$ $T_C = 25^{\circ}\text{C}$ $T_C = 100^{\circ}\text{C}$	I_D	52 36	A
Pulsed drain current, t_p limited by $T_{vj,max}$, $V_{GS} = 15\text{V}$	$I_{D,pulse}$	130	A
DC body diode forward current for $R_{th(j-c,max)}$, limited by $T_{vj,max}$, $V_{GS}=0\text{V}$ $T_C = 25^{\circ}\text{C}$ $T_C = 100^{\circ}\text{C}$	I_{SD}	52 28	A
Pulsed body diode current, t_p limited by $T_{vj,max}$	$I_{SD,pulse}$	130	A
Gate-source voltage ² Max transient voltage, < 1% duty cycle Recommended turn-on gate voltage Recommended turn-off gate voltage	V_{GSS} $V_{GSS,on}$ $V_{GSS,off}$	-7... 20 15 0	V
Power dissipation, limited by $T_{vj,max}$ $T_C = 25^{\circ}\text{C}$ $T_C = 100^{\circ}\text{C}$	P_{tot}	228 114	W
Virtual junction temperature	T_{vj}	-40...175	$^{\circ}\text{C}$
Storage temperature	T_{stg}	-55...150	$^{\circ}\text{C}$
Soldering temperature, wavesoldering only allowed at leads, 1.6mm (0.063 in.) from case for 10 s	T_{sold}	260	$^{\circ}\text{C}$
Mounting torque, M3 screw Maximum of mounting processes: 3	M	0.6	Nm

¹ Not subject to production test. Parameter verified by design/characterization.

² **Important note:** The selection of positive and negative gate-source voltages impacts the long-term behavior of the device. The design guidelines described in [Application Note AN2018-09](#) must be considered to ensure sound operation of the device over the planned lifetime.

Thermal resistances

2 Thermal resistances

Table 3 Thermal resistances¹

Parameter	Symbol	Conditions	Value			Unit
			min.	typ.	max.	
MOSFET/body diode thermal resistance, junction – case	$R_{th(j-c)}$		-	0.51	0.66	K/W
Thermal resistance, junction – ambient	$R_{th(j-a)}$	leaded	-	-	62	K/W

¹ Not subject to production test. Parameter verified by design/characterization.

3 Electrical Characteristics

3.1 Static characteristics

Table 4 Static characteristics (at $T_{vj}=25^{\circ}\text{C}$, unless otherwise specified)

Parameter	Symbol	Conditions	Value			Unit
			min.	typ.	max.	
Drain-source on-state resistance ²	$R_{DS(on)}$	$V_{GS}=15\text{V}$, $I_D=20\text{A}$, $T_{vj} = 25^{\circ}\text{C}$ $T_{vj} = 100^{\circ}\text{C}$ $T_{vj} = 175^{\circ}\text{C}$	- - -	45 55 75	59 - -	$\text{m}\Omega$
Body Diode forward voltage	V_{SD}	$V_{GS} = 0\text{V}$, $I_{SD}=20\text{A}$ $T_{vj} = 25^{\circ}\text{C}$ $T_{vj} = 100^{\circ}\text{C}$ $T_{vj} = 175^{\circ}\text{C}$	- - -	4.1 4.0 3.9	5.2 - -	V
Gate-source threshold voltage ²	$V_{GS(th)}$	(tested after 1 ms pulse at $V_{GS}=+20\text{V}$) $I_D = 10\text{mA}$, $V_{DS} = V_{GS}$ $T_{vj} = 25^{\circ}\text{C}$ $T_{vj} = 175^{\circ}\text{C}$	3.5 -	4.5 3.6	5.7 -	V
Zero gate voltage drain current	I_{DSS}	$V_{GS} = 0\text{V}$, $V_{DS} = 1200\text{V}$ $T_{vj}=25^{\circ}\text{C}$ $T_{vj}=175^{\circ}\text{C}$	- -	2 50	200 -	μA
Gate-source leakage current	I_{GSS}	$V_{GS} = 20\text{V}$, $V_{DS} = 0\text{V}$	-	-	120	nA
		$V_{GS} = -10\text{V}$, $V_{DS} = 0\text{V}$	-	-	-120	nA
Transconductance	g_{fs}	$V_{DS} = 20\text{V}$, $I_D = 20\text{A}$	-	11.1	-	S
Internal gate resistance	$R_{G,int}$	$f = 1\text{MHz}$, $V_{AC} = 25\text{mV}$	-	4.5	-	Ω

² **Important note:** The selection of positive and negative gate-source voltages impacts the long-term behavior of the device. The design guidelines described in [Application Note AN2018-09](#) must be considered to ensure sound operation of the device over the planned lifetime.

Electrical Characteristics

3.2 Dynamic characteristics

Table 5 Dynamic characteristics (at $T_{vj}=25^{\circ}\text{C}$, unless otherwise specified)

Parameter	Symbol	Conditions	Value			Unit
			min.	typ.	max.	
Input capacitance	C_{iss}	$V_{DS} = 800\text{V}, V_{GS} = 0\text{V}, f = 1\text{MHz},$ $V_{AC} = 25\text{mV}$	-	2130	-	pF
Output capacitance	C_{oss}			107		
Reverse capacitance	C_{rss}			11		
C_{oss} stored energy	E_{oss}			44		
Total gate charge	Q_G	$V_{DD} = 800\text{V}, I_D = 20\text{A},$ $V_{GS} = 0/15\text{V}, \text{turn-on pulse}$	-	57	-	nC
Gate to source charge	$Q_{GS,pl}$			19		
Gate to drain charge	Q_{GD}			13		
Short-circuit withstand time ³	t_{SC}	$V_{DD} = 800\text{V}, L_{\sigma} = 80\text{nH},$ $R_{G,ext} = 90\text{ohm}, T_{vj} = 175^{\circ}\text{C}$ $V_{GS,on} = 15\text{V}$	-	3	-	μs

³ Verified by design for single short circuit event at $V_{GS,on} = 15\text{V}$.

Electrical Characteristics

3.3 Switching characteristics

Table 6 Switching characteristics, Inductive load ⁴

Parameter	Symbol	Conditions	Value			Unit
			min.	typ.	max.	
MOSFET Characteristics, $T_{vj}=25^{\circ}\text{C}$						
Turn-on delay time	$t_{d(on)}$	$V_{DD}=800\text{V}$, $I_D=20\text{A}$, $V_{GS}=0\text{V}/15\text{V}$, $R_{G,ext}=2\Omega$, $L_{\sigma}=40\text{nH}$, diode: body diode at $V_{GS}=0\text{V}$ see Fig. E	-	9	-	ns
Rise time	t_r		-	32	-	ns
Turn-off delay time	$t_{d(off)}$		-	17	-	ns
Fall time	t_f		-	13	-	ns
Turn-on energy	E_{on}		-	450	-	μJ
Turn-off energy	E_{off}		-	70	-	μJ
Total switching energy	E_{tot}		-	520	-	μJ

Body Diode Characteristics, $T_{vj}=25^{\circ}\text{C}$

Diode reverse recovery charge	Q_{rr}	$V_{DD} = 800\text{V}$, $I_{SD}=20\text{A}$, V_{GS} at diode=0V, $di_i/dt=1000\text{A}/\mu\text{s}$,	-	0.15	-	μC
Diode peak reverse recovery current	I_{rrm}	Q_{rr} includes also Q_C , see Fig. C	-	8	-	A

MOSFET Characteristics, $T_{vj}=175^{\circ}\text{C}$

Turn-on delay time	$t_{d(on)}$	$V_{DD}=800\text{V}$, $I_D=20\text{A}$, $V_{GS}=0\text{V}/15\text{V}$, $R_{G,ext}=2\Omega$, $L_{\sigma}=40\text{nH}$, diode: body diode at $V_{GS}=0\text{V}$, see Fig. E	-	9	-	ns
Rise time	t_r		-	32	-	ns
Turn-off delay time	$t_{d(off)}$		-	20	-	ns
Fall time	t_f		-	14	-	ns
Turn-on energy	E_{on}		-	490	-	μJ
Turn-off energy	E_{off}		-	75	-	μJ
Total switching energy	E_{tot}		-	565	-	μJ

Body Diode Characteristics, $T_{vj}=175^{\circ}\text{C}$

Diode reverse recovery charge	Q_{rr}	$V_{DD} = 800\text{V}$, $I_{SD}=20\text{A}$, V_{GS} at diode=0V, $di_i/dt=1000\text{A}/\mu\text{s}$,	-	0.25	-	μC
Diode peak reverse recovery current	I_{rrm}	Q_{rr} includes also Q_C , see Fig. C	-	10	-	A

⁴ The chip technology was characterized up to 200 kV/ μs . The measured dv/dt was limited by measurement test setup and package.

4 Electrical characteristic diagrams

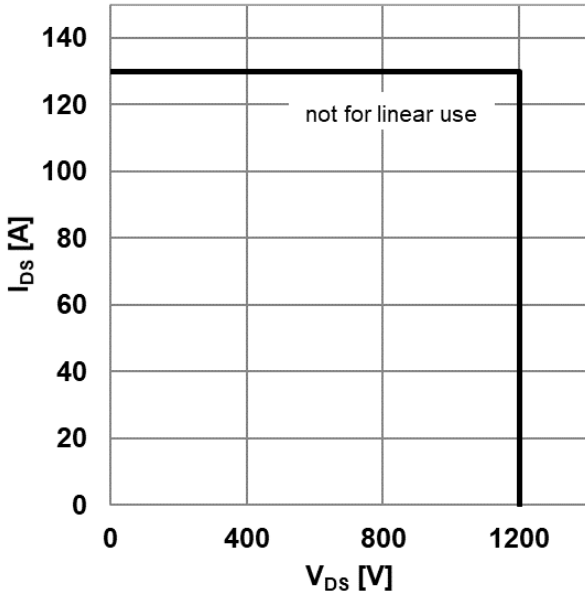

Figure 1 Reverse bias safe operating area (RBSOA) ($V_{GS} = 0/15V$, $T_c = 25^\circ C$, $T_j < 175^\circ C$)

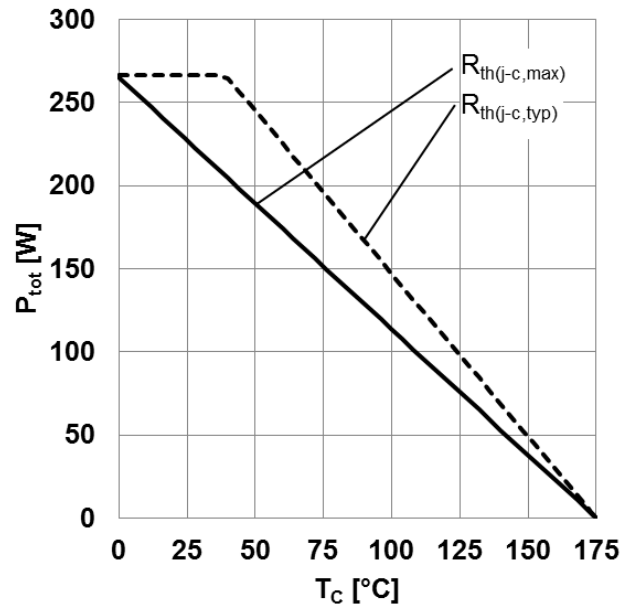

Figure 2 Power dissipation as a function of case temperature limited by bond wire ($P_{tot} = f(T_c)$)

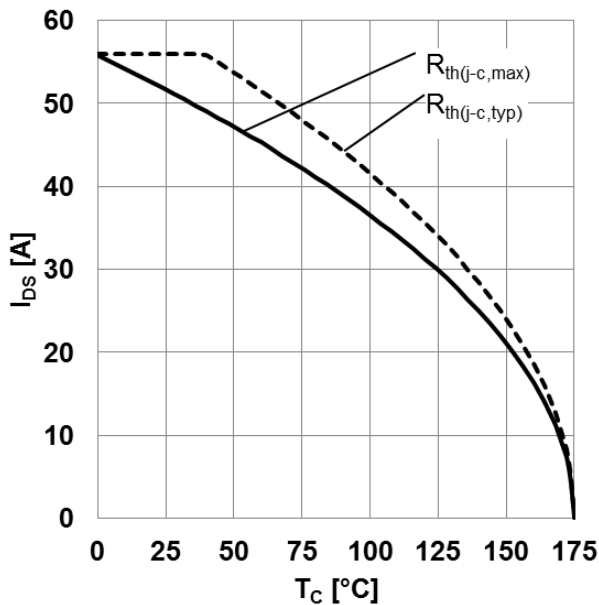

Figure 3 Maximum DC drain to source current as a function of case temperature limited by bond wire ($I_{DS} = f(T_c)$)

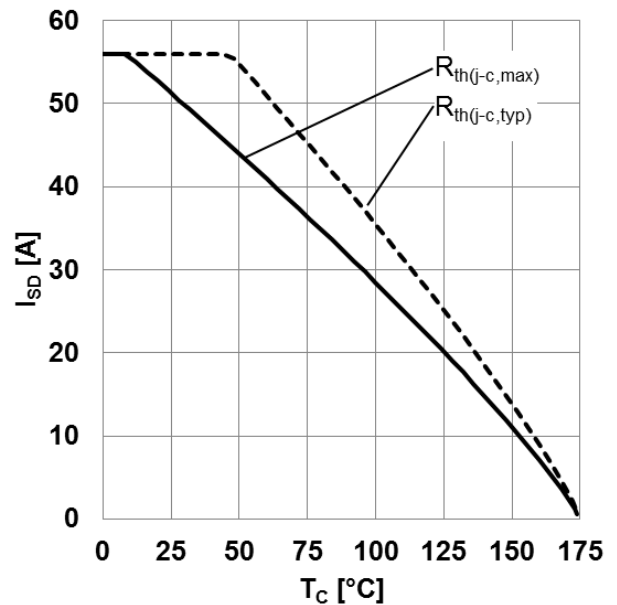

Figure 4 Maximum source to drain current as a function of case temperature limited by bond wire ($I_{SD} = f(T_c)$, $V_{GS} = 0V$)

Electrical characteristic diagrams

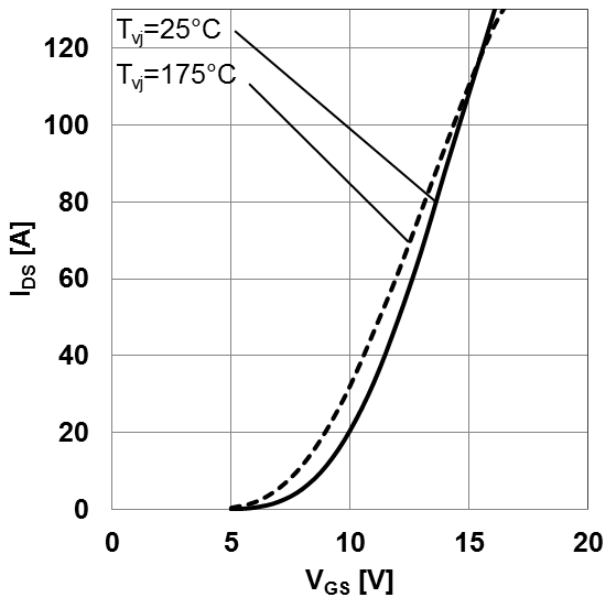

Figure 5 Typical transfer characteristic
 ($I_{DS}=f(V_{GS}), V_{DS}=20V, t_P = 20 \mu s$)

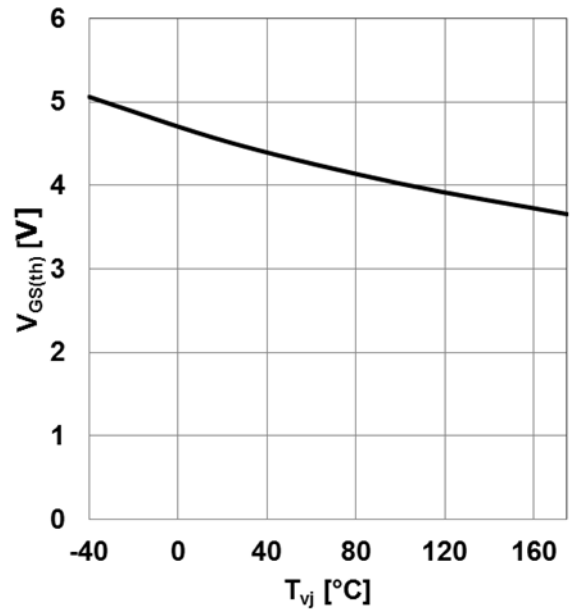

Figure 6 Typical gate-source threshold voltage as a function of junction temperature
 ($V_{GS(th)}=f(T_{vj}), I_{DS}=10mA, V_{GS}=V_{DS}$)

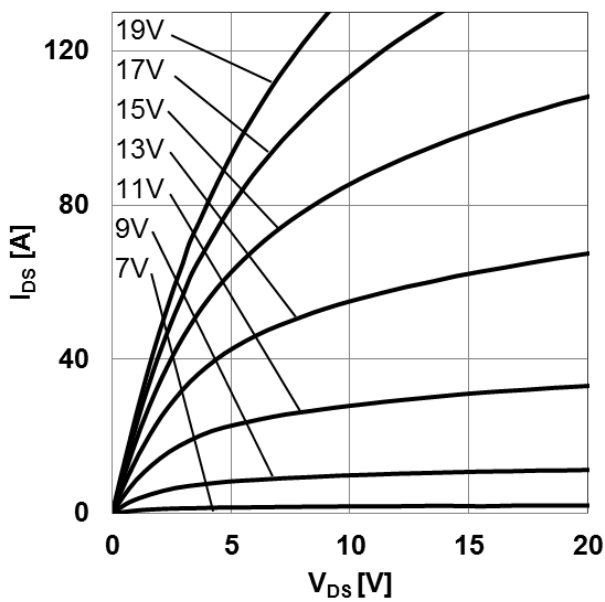

Figure 7 Typical output characteristic, V_{GS} as parameter ($I_{DS}=f(V_{DS}), T_{vj}=25^\circ C, t_P = 20 \mu s$)

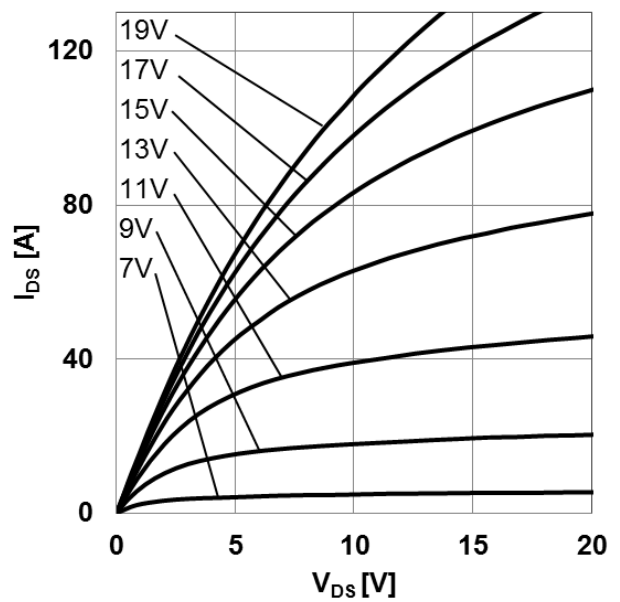

Figure 8 Typical output characteristic, V_{GS} as parameter ($I_{DS}=f(V_{DS}), T_{vj}=175^\circ C, t_P = 20 \mu s$)

Electrical characteristic diagrams

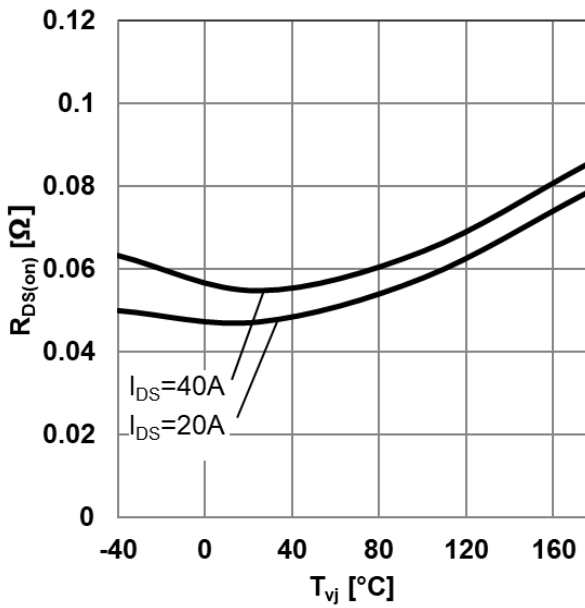

Figure 9 Typical on-resistance as a function of junction temperature ($R_{DS(on)}=f(T_{vj})$, $V_{GS}=15V$)

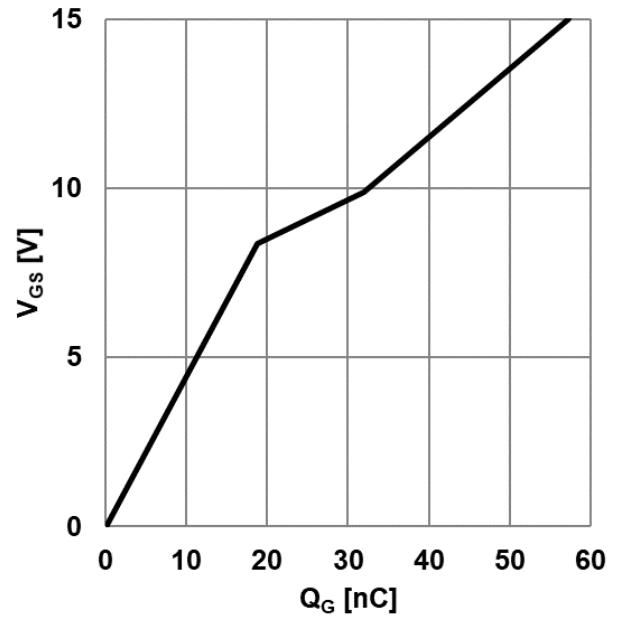

Figure 10 Typical gate charge ($V_{GS}=f(Q_G)$, $I_{DS}=20A$, $V_{DS}=800V$, turn-on pulse)

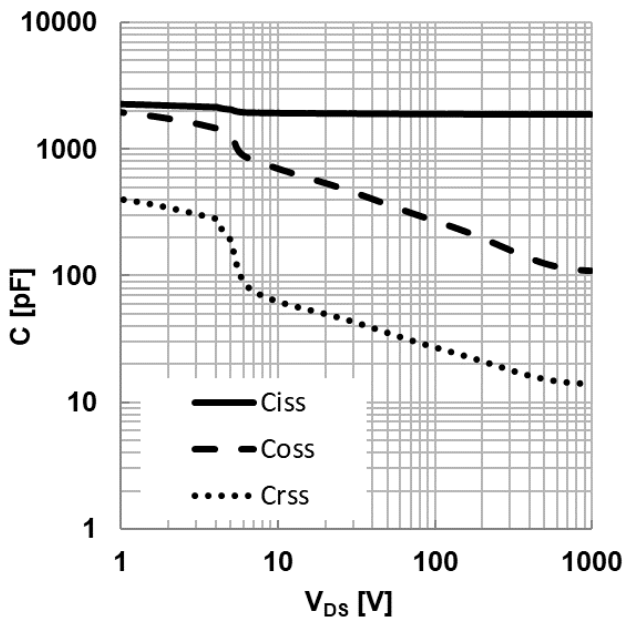

Figure 11 Typical capacitance as a function of drain-source voltage ($C=f(V_{DS})$, $V_{GS}=0V$, $f=1MHz$)

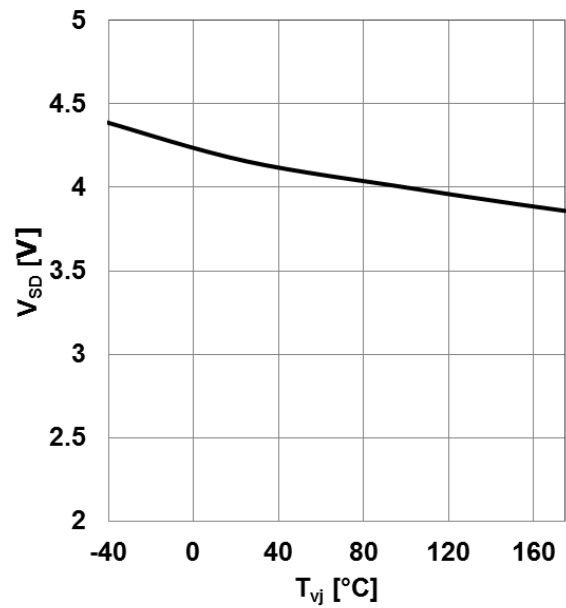

Figure 12 Typical body diode forward voltage as function of junction temperature ($V_{SD}=f(T_{vj})$, $V_{GS}=0V$, $I_{SD}=20A$)

Electrical characteristic diagrams

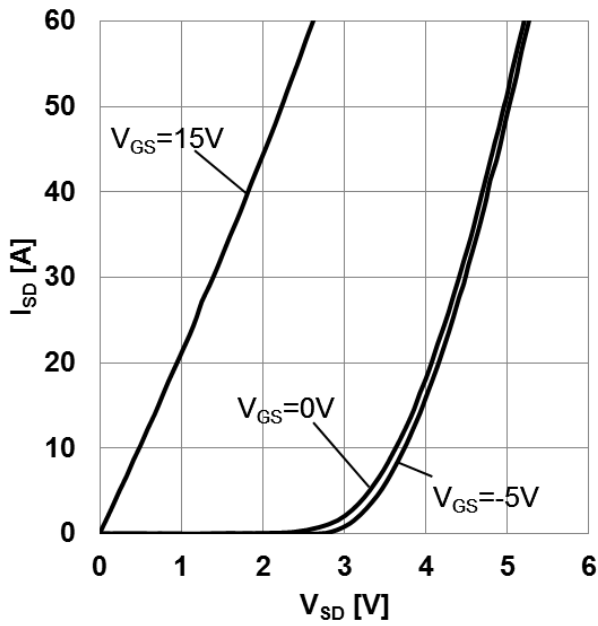

Figure 13 Typical body diode forward current as a function of forward voltage, V_{GS} as parameter ($I_{SD}=f(V_{SD})$, $T_{vj}=25^{\circ}\text{C}$, $t_P=20\ \mu\text{s}$)

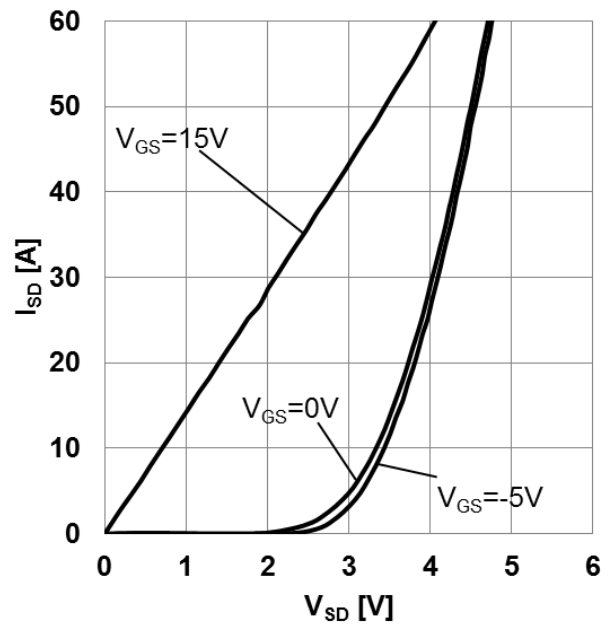

Figure 14 Typical body diode forward current as a function of forward voltage, V_{GS} as parameter ($I_{SD}=f(V_{SD})$, $T_{vj}=175^{\circ}\text{C}$, $t_P=20\ \mu\text{s}$)

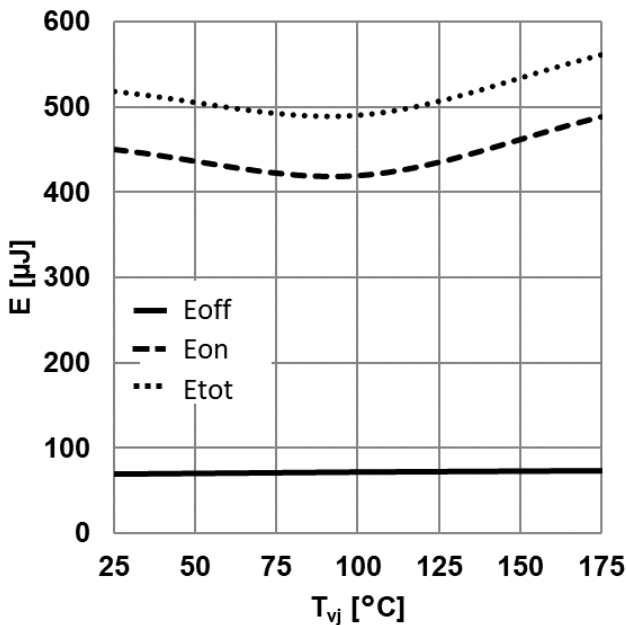

Figure 15 Typical switching energy losses as a function of junction temperature ($E=f(T_{vj})$, $V_{DD}=800\text{V}$, $V_{GS}=0\text{V}/15\text{V}$, $R_{G,ext}=2\ \Omega$, $I_D=20\text{A}$, ind. load, test circuit in Fig. E, diode: body diode)

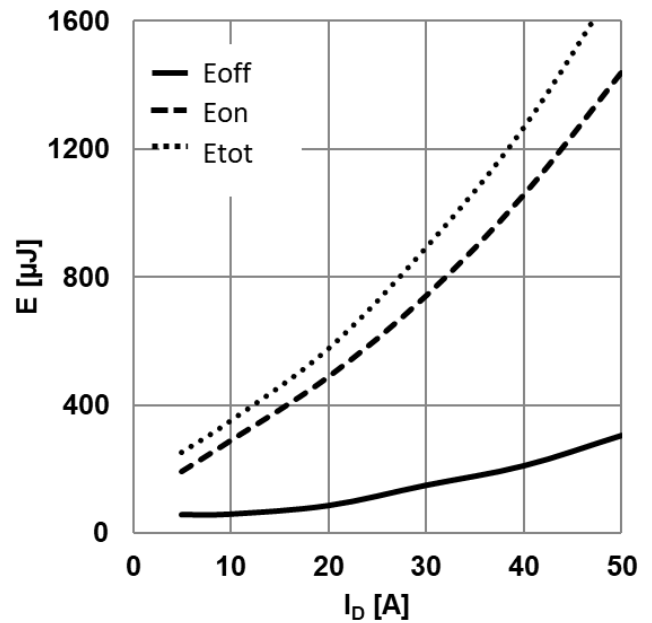

Figure 16 Typical switching energy losses as a function of drain-source current ($E=f(I_{DS})$, $V_{DD}=800\text{V}$, $V_{GS}=0\text{V}/15\text{V}$, $R_{G,ext}=2\ \Omega$, $T_{vj}=175^{\circ}\text{C}$, ind. load, test circuit in Fig. E, diode: body diode)

Electrical characteristic diagrams

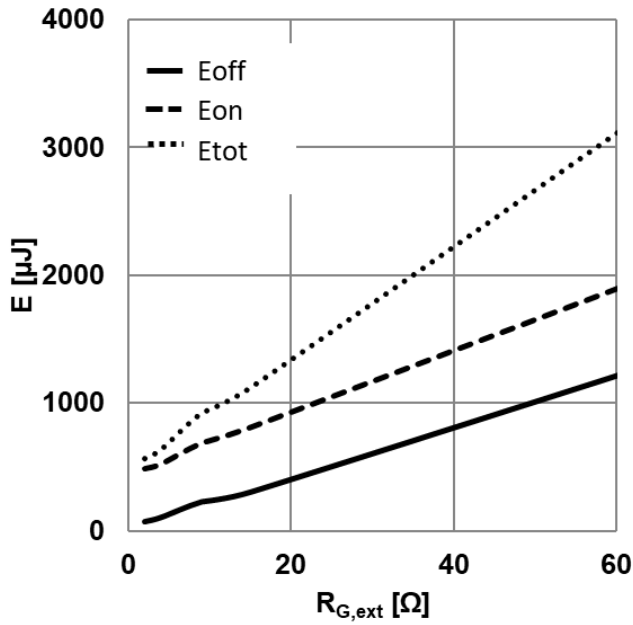

Figure 17 Typical switching energy losses as a function of gate resistance ($E=f(R_{G,ext})$, $V_{DD}=800V$, $V_{GS}=0V/15V$, $I_D=20A$, $T_{vj}=175^{\circ}C$, ind. load, test circuit in Fig. E, diode: body diode)

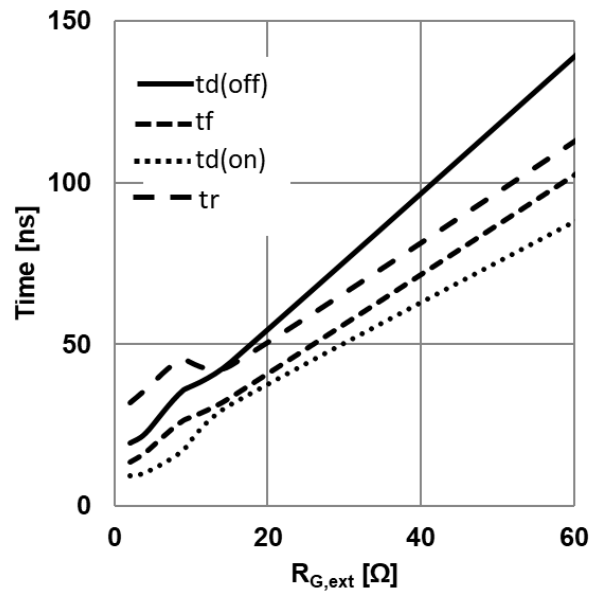

Figure 18 Typical switching times as a function of gate resistor ($t=f(R_{G,ext})$, $V_{DD}=800V$, $V_{GS}=0V/15V$, $I_D=20A$, $T_{vj}=175^{\circ}C$, ind. load, test circuit in Fig. E, diode: body diode)

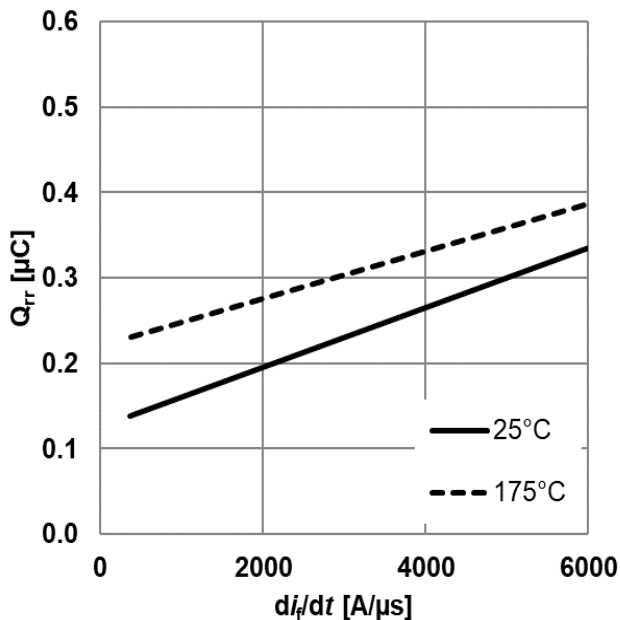

Figure 19 Typical reverse recovery charge as a function of diode current slope ($Q_{rr}=f(di_f/dt)$, $V_{DD}=800V$, $I_D=20A$, ind. load, test circuit in Fig.E)

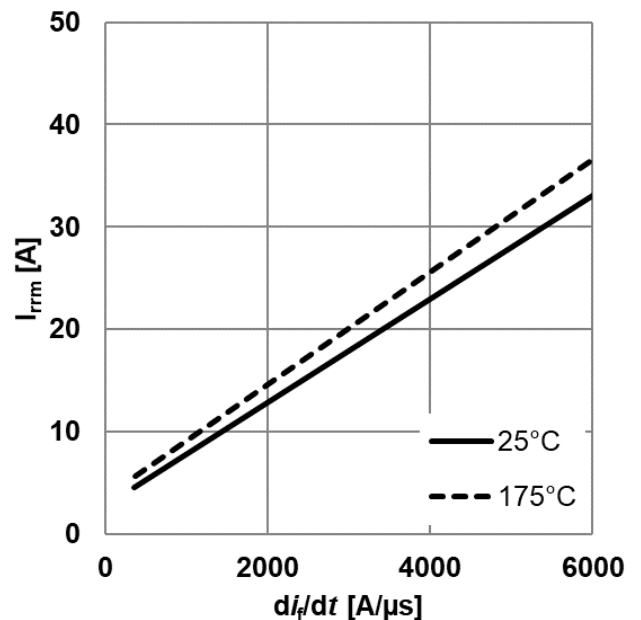

Figure 20 Typical reverse recovery current as a function of diode current slope ($I_{rrm}=f(di_f/dt)$, $V_{DD}=800V$, $I_D=20A$, ind. load, test circuit in Fig.E)

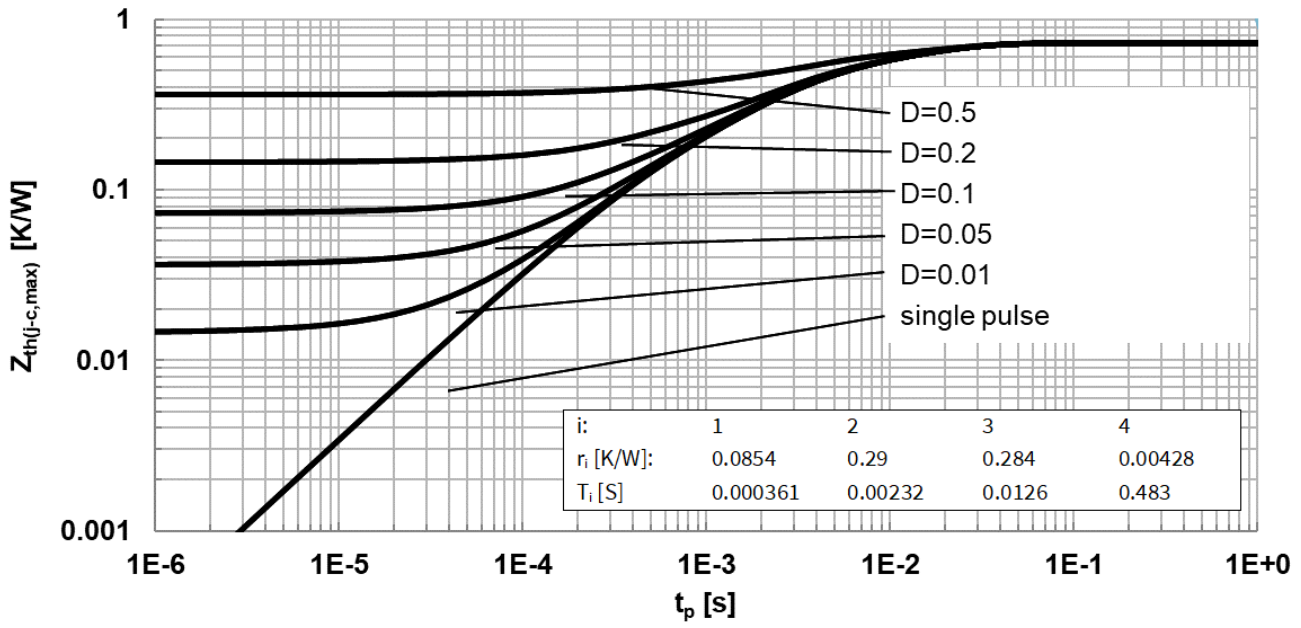
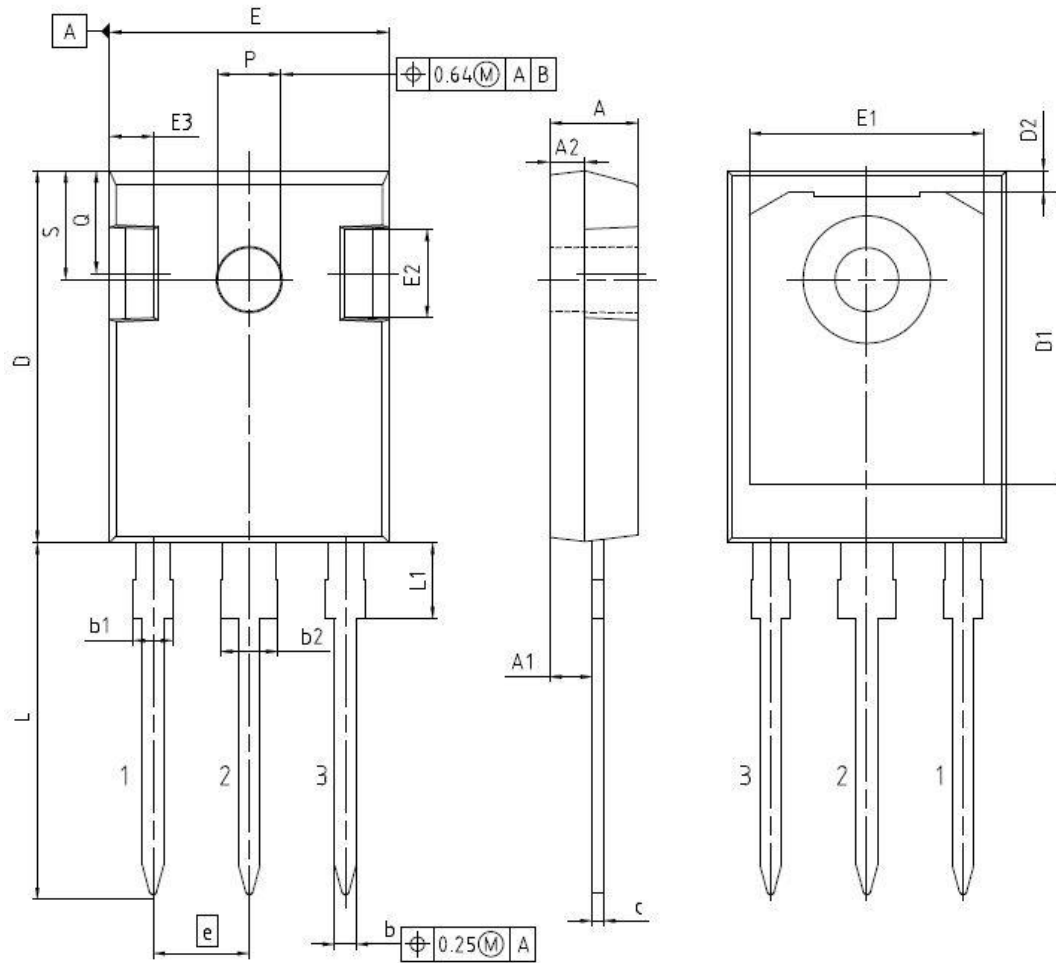

Figure 21 Max. transient thermal resistance (MOSFET/diode)
 $(Z_{th(j-c,max)} = f(t_p), \text{ parameter } D = t_p/T, \text{ thermal equivalent circuit in Fig. D})$

5 Package drawing

PG-TO247-3-41



DIMENSIONS	MILLIMETERS	
	MIN.	MAX.
A	4.70	5.30
A1	2.20	2.60
A2	1.50	2.50
b	1.00	1.40
b1	1.60	2.41
b2	2.57	3.43
c	0.38	0.89
D	20.70	21.50
D1	13.08	17.65
D2	0.51	1.35
E	15.50	16.30
E1	12.38	14.15
E2	3.40	5.10
E3	1.00	2.60
e	5.44	
L	19.80	20.40
L1	3.85	4.50
P	3.50	3.70
Q	5.35	6.25
S	6.04	6.30

DOCUMENT NO. Z8B00003327
REVISION 06
SCALE 3:1 0 1 2 3 4 5mm
EUROPEAN PROJECTION
ISSUE DATE 25.07.2018

Figure 22 Package drawing

Test conditions

6 Test conditions

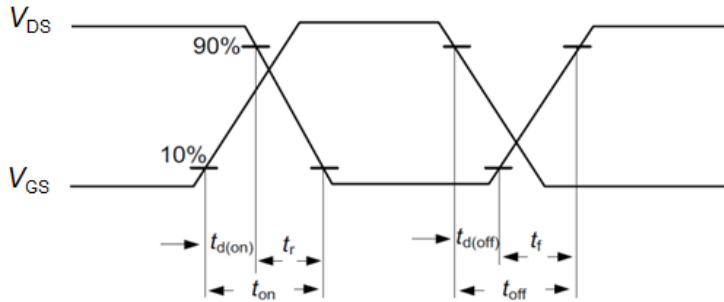

Figure A. Definition of switching times

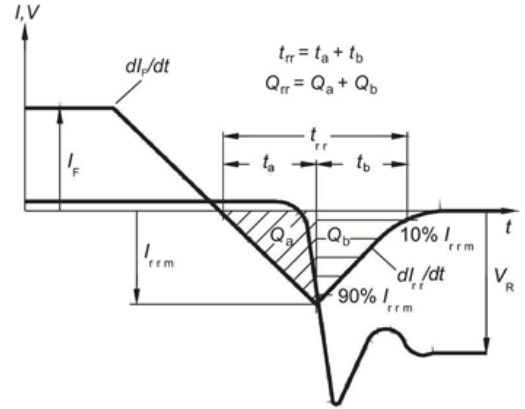

Figure C. Definition of diode switching characteristics

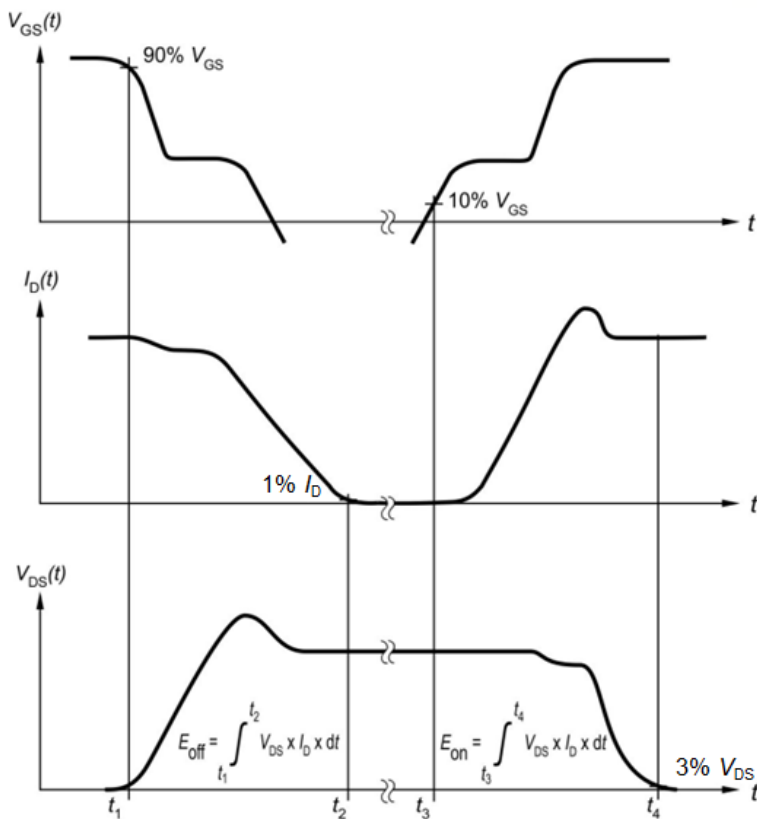

Figure B. Definition of switching losses

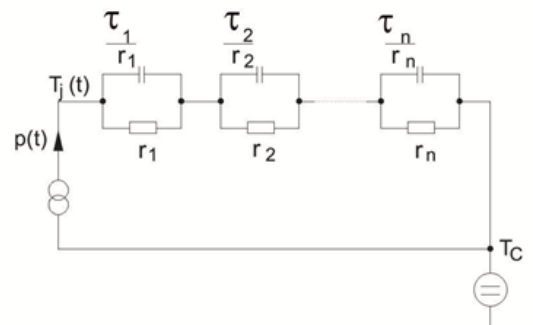

Figure D. Thermal equivalent circuit

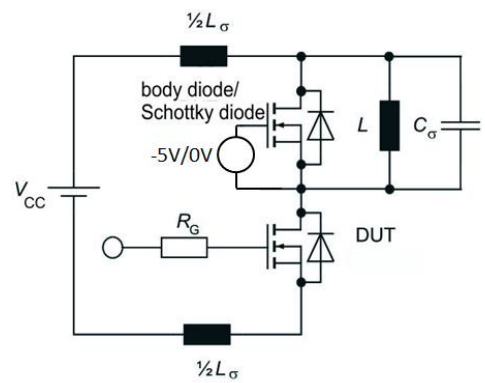

Figure E. Dynamic test circuit

Parasitic inductance L_σ ,
parasitic capacitor C_σ ,

Figure 23 Test conditions

Revision History

Revision History

Major changes since the last revision

Page or Reference	Description of change
All pages	First release of datasheet V3.0

Trademarks

All referenced product or service names and trademarks are the property of their respective owners.

Published by

Infineon Technologies AG

81726 München, Germany

© Infineon Technologies AG 2019.

All Rights Reserved.

Important notice

The information given in this document shall in no event be regarded as a guarantee of conditions or characteristics ("Beschaffheitsgarantie"). With respect to any examples, hints or any typical values stated herein and/or any information regarding the application of the product, Infineon Technologies hereby disclaims any and all warranties and liabilities of any kind, including without limitation warranties of non-infringement of intellectual property rights of any third party.

In addition, any information given in this document is subject to customer's compliance with its obligations stated in this document and any applicable legal requirements, norms and standards concerning customer's products and any use of the product of Infineon Technologies in customer's applications.

The data contained in this document is exclusively intended for technically trained staff. It is the responsibility of customer's technical departments to evaluate the suitability of the product for the intended application and the completeness of the product information given in this document with respect to such application.

For further information on the product, technology, delivery terms and conditions and prices please contact your nearest Infineon Technologies office (www.infineon.com).

Warnings

Due to technical requirements products may contain dangerous substances. For information on the types in question please contact your nearest Infineon Technologies office.

Except as otherwise explicitly approved by Infineon Technologies in a written document signed by authorized representatives of Infineon Technologies, Infineon Technologies' products may not be used in any applications where a failure of the product or any consequences of the use thereof can reasonably be expected to result in personal injury.