

## PNP Transistors

### H8550D

#### ■ Features

- Collector Power Dissipation:  $P_c=0.5W$
- Collector Current:  $I_c=-1.5A$

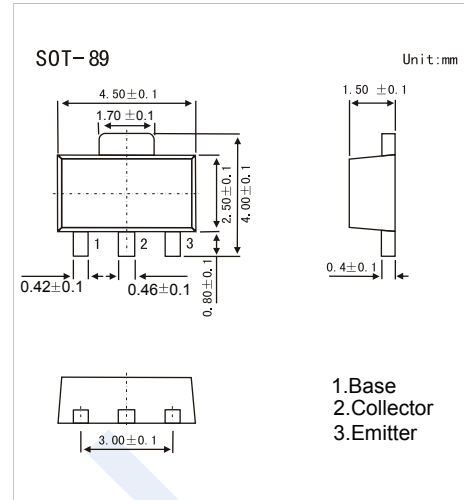

#### ■ Absolute Maximum Ratings $T_a = 25^\circ C$

Parameter	Symbol	Rating	Unit
Collector-base voltage	$V_{CB0}$	-40	V
Collector-emitter voltage	$V_{CE0}$	-25	V
Emitter-base voltage	$V_{EB0}$	-5	V
Collector current	$I_c$	-1.5	A
Collector power dissipation	$P_c$	0.5	W
Junction temperature	$T_j$	150	$^\circ C$
Storage temperature	$T_{stg}$	-55 to +150	$^\circ C$

#### ■ Electrical Characteristics $T_a = 25^\circ C$

Parameter	Symbol	Test conditions	Min	Typ	Max	Unit
Collector-base breakdown voltage	$V_{CB0}$	$I_c = -100 \mu A, I_E = 0$	-40			V
Collector-emitter breakdown voltage	$V_{CE0}$	$I_c = -0.1mA, I_B = 0$	-25			V
Emitter-base breakdown voltage	$V_{EB0}$	$I_E = -100 \mu A, I_C = 0$	-5			V
Collector cut-off current	$I_{CBO}$	$V_{CB} = -40V, I_E = 0$			-0.1	$\mu A$
Collector cut-off current	$I_{CEO}$	$V_{CE} = -20V, I_B = 0$			-0.1	$\mu A$
Emitter cut-off current	$I_{EBO}$	$V_{EB} = -5V, I_C = 0$			-0.1	$\mu A$
DC current gain	$h_{FE}$	$V_{CE} = -1V, I_c = -100mA$	85		400	
		$V_{CE} = -1V, I_c = -800mA$	40			
Collector-emitter saturation voltage	$V_{CE(sat)}$	$I_c = -800mA, I_B = -80mA$			-0.5	V
Base-emitter saturation voltage	$V_{BE(sat)}$	$I_c = -800mA, I_B = -80mA$			-1.2	V
Base-emitter on voltage	$V_{BE(on)}$	$I_c = -1V, V_{CE} = -10mA$			-1	V
Base-emitter positive favor voltage	$V_{BEF}$	$I_B = -1A$			-1.55	V
output capacitance	$C_{ob}$	$V_{CB} = -10V, I_E = 0, f = 1MHz$			20	pF
Transition frequency	$f_T$	$V_{CE} = -10V, I_c = -50mA$	100			MHz

#### ■ Classification of $h_{fe}(1)$

Marking	8550*			
Range	B	C	D	D3
$h_{FE}$	85~160	120~200	160~300	300~400

# PNP Transistors

## H8550D

### Typical Characteristics

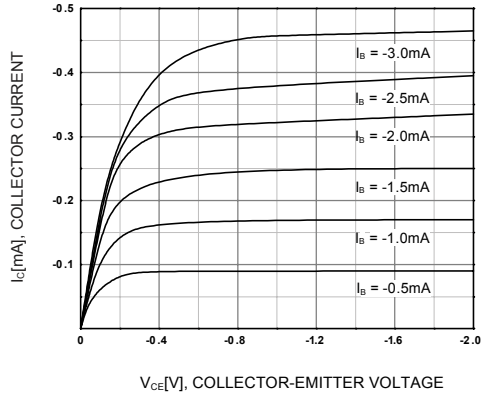

Figure 1. Static Characteristic

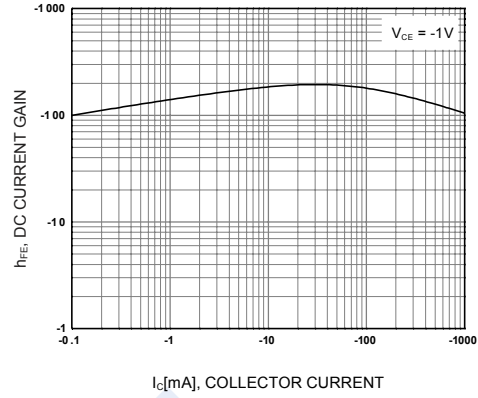

Figure 2. DC current Gain

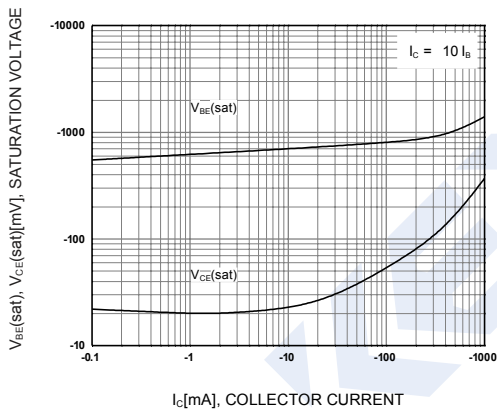

Figure 3. Base-Emitter Saturation Voltage  
Collector-Emitter Saturation Voltage

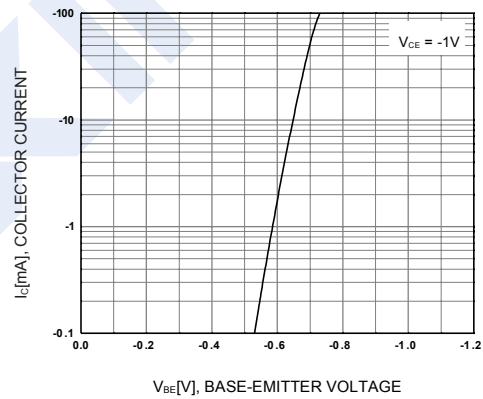

Figure 4. Base-Emitter On Voltage

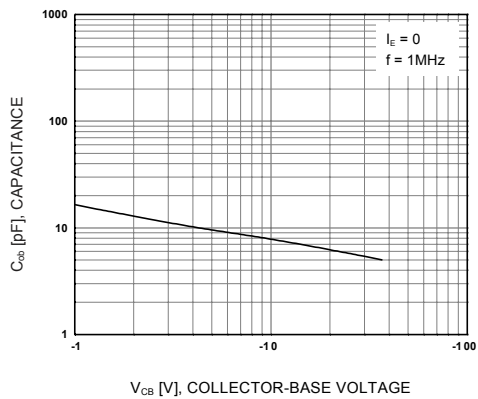

Figure 5. Collector Output Capacitance

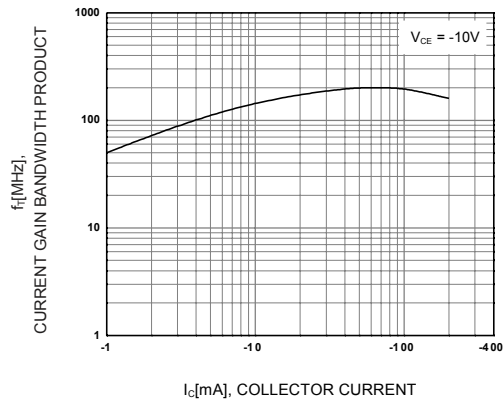

Figure 6. Current Gain Bandwidth Product