



Is Now Part of



ON Semiconductor®

To learn more about ON Semiconductor, please visit our website at
www.onsemi.com

Please note: As part of the Fairchild Semiconductor integration, some of the Fairchild orderable part numbers will need to change in order to meet ON Semiconductor's system requirements. Since the ON Semiconductor product management systems do not have the ability to manage part nomenclature that utilizes an underscore (_), the underscore (_) in the Fairchild part numbers will be changed to a dash (-). This document may contain device numbers with an underscore (_). Please check the ON Semiconductor website to verify the updated device numbers. The most current and up-to-date ordering information can be found at www.onsemi.com. Please email any questions regarding the system integration to Fairchild_questions@onsemi.com.

ON Semiconductor and the ON Semiconductor logo are trademarks of Semiconductor Components Industries, LLC dba ON Semiconductor or its subsidiaries in the United States and/or other countries. ON Semiconductor owns the rights to a number of patents, trademarks, copyrights, trade secrets, and other intellectual property. A listing of ON Semiconductor's product/patent coverage may be accessed at www.onsemi.com/site/pdf/Patent-Marking.pdf. ON Semiconductor reserves the right to make changes without further notice to any products herein. ON Semiconductor makes no warranty, representation or guarantee regarding the suitability of its products for any particular purpose, nor does ON Semiconductor assume any liability arising out of the application or use of any product or circuit, and specifically disclaims any and all liability, including without limitation special, consequential or incidental damages. Buyer is responsible for its products and applications using ON Semiconductor products, including compliance with all laws, regulations and safety requirements or standards, regardless of any support or applications information provided by ON Semiconductor. "Typical" parameters which may be provided in ON Semiconductor data sheets and/or specifications can and do vary in different applications and actual performance may vary over time. All operating parameters, including "Typicals" must be validated for each customer application by customer's technical experts. ON Semiconductor does not convey any license under its patent rights nor the rights of others. ON Semiconductor products are not designed, intended, or authorized for use as a critical component in life support systems or any FDA Class 3 medical devices or medical devices with a same or similar classification in a foreign jurisdiction or any devices intended for implantation in the human body. Should Buyer purchase or use ON Semiconductor products for any such unintended or unauthorized application, Buyer shall indemnify and hold ON Semiconductor and its officers, employees, subsidiaries, affiliates, and distributors harmless against all claims, costs, damages, and expenses, and reasonable attorney fees arising out of, directly or indirectly, any claim of personal injury or death associated with such unintended or unauthorized use, even if such claim alleges that ON Semiconductor was negligent regarding the design or manufacture of the part. ON Semiconductor is an Equal Opportunity/Affirmative Action Employer. This literature is subject to all applicable copyright laws and is not for resale in any manner.



FAN7385

双通道高侧栅极驱动 IC

特性

- 浮动通道可实现高达 +600V 的自举运行
- 350mA/650mA 的典型源电流 / 灌电流驱动能力
- 在 $V_{DD} = V_{BS} = 15\text{ V}$ 时信号传播过程中, 扩展允许负 V_S 摆幅低至 -9.8 V
- 高侧输出与输入信号同相
- V_{DD} 和 V_{BS} 供电范围从 10 V 至 20 V
- 兼容 3.3V 和 5V 逻辑输入电平
- 内置共模 dv/dt 噪声消除电路
- 两个通道均内置欠压锁定 (UVLO) 功能

应用

- 标准半桥和全桥驱动器
- PDP 能量恢复开关控制驱动器
- 开关电源

说明

FAN7385 是单片高侧栅极驱动 IC, 设计用于高压、高速驱动 MOSFET 和 IGBT, 工作电压高达 +600 V。

飞兆半导体的高压工艺和共模噪声消除技术可以保证高端驱动器在高 dv/dt 噪声环境下稳定工作。

先进的电平转换电路能使高侧栅极驱动器的工作偏置电压达到 $V_S = -9.8\text{ V}$ ($V_{BS} = 15\text{ V}$ 时的典型值)。

UVLO 电路可防止 V_{BS1} 和 V_{BS2} 低于指定的阈值电压时发生故障。

输出驱动器通常提供 350mA/650mA 的源电流 / 灌电流, 适合双通道高侧开关和半桥逆变器。

14-SOP

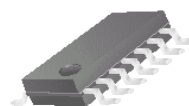

订购信息

器件编号	封装	无铅	工作温度范围	包装方法
FAN7385M ⁽¹⁾	14-SOP	是	-40°C ~ 125°C	塑料管
FAN7385MX ⁽¹⁾				卷带和卷盘

注:

1. 这些器件通过了 JESD22A-111 波峰焊测试。

应用电路图



图 1. 浮动双向开关控制 PDP 应用



图 2. 全桥电源应用

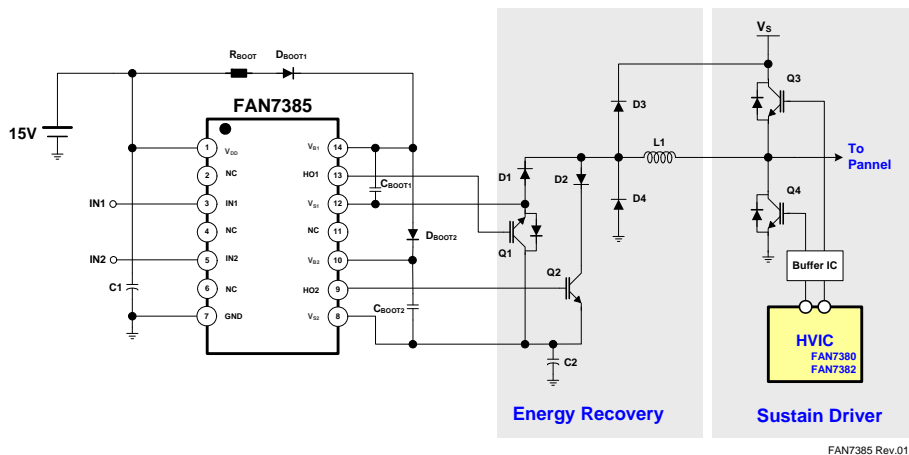

图 3. 半桥 LCC 谐振转换器应用

引脚配置

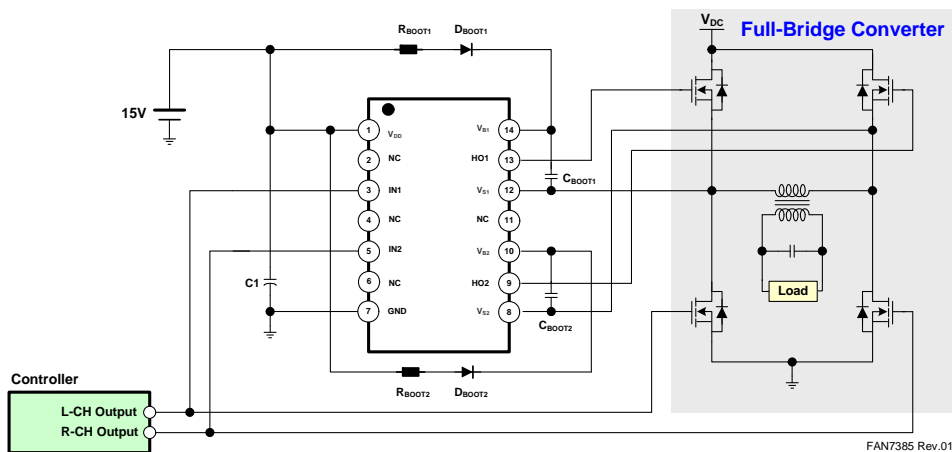

图 5. 引脚配置（俯视图）

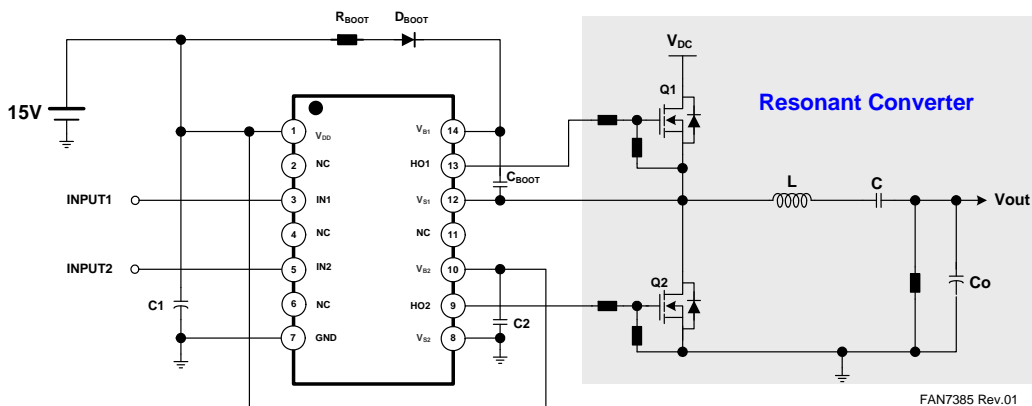
引脚定义

引脚号	名称	说明
1	V_{DD}	电源
2	NC	无连接
3	IN1	通道 1 控制输入
4	NC	无连接
5	IN2	通道 2 控制输入
6	NC	无连接
7	GND	接地
8	V_{S2}	通道 2 浮动电源返回
9	HO2	通道 2 输出
10	V_{B2}	通道 2 浮动电源
11	NC	无连接
12	V_{S1}	通道 1 浮动电源返回
13	HO1	通道 1 输出
14	V_{B1}	通道 1 浮动电源

绝对最大额定值

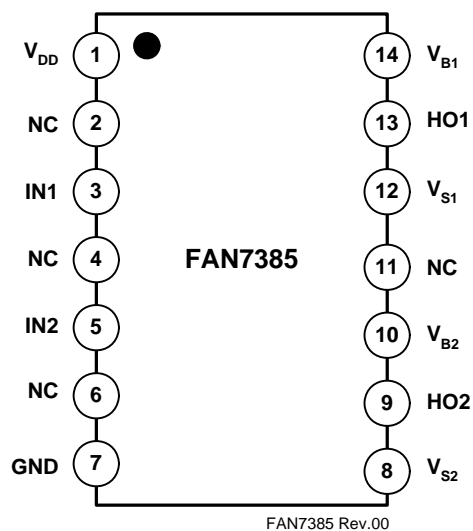
应力超过绝对最大额定值，可能会损坏器件。在超出推荐的工作条件的情况下，该器件可能无法正常工作，所以不建议让器件在这些条件下长期工作。此外，长期在高于推荐的工作条件下工作，会影响器件的可靠性。绝对最大额定值仅是应力规格值。除非另有说明， $T_A = 25^\circ\text{C}$ 。

符号	参数	最小值	最大值	单位
V_S	高侧偏置电压 V_{S1} 、 V_{S2}	$V_B - 25$	$V_B + 0.3$	V
V_B	高侧浮动电源电压 V_{B1} 、 V_{B2}	-0.3	625	V
V_{HO}	高侧浮动输出电压 H_{O1} 、 H_{O2}	$V_S - 0.3$	$V_B + 0.3$	V
V_{DD}	低侧和固定逻辑电源电压	-0.3	25	V
V_{IN}	逻辑输入电压 ($IN1$ 、 $IN2$)	-0.3	$V_{DD} + 0.3$	V
GND	逻辑地	$V_{DD} - 25$	$V_{DD} + 0.3$	V
dV_S/dt	允许的偏置电压变化速率		50	V/ns
$P_D^{(2)(3)(4)}$	功耗		1.0	W
θ_{JA}	结至环境热阻		110	$^\circ\text{C}/\text{W}$
T_J	结温		150	$^\circ\text{C}$
T_S	存储温度		150	$^\circ\text{C}$

注意：

2. 安装到 76.2 x 114.3 x 1.6 mm PCB 板（FR-4 环氧玻璃材料）。

3. 参考以下标准：

JESD51-2: 集成电路热测试方法环境条件 - 自然对流

JESD51-3: 含铅表面贴装封装的低有效导热系数测试板

4. 在任何情况下，都不要超过 P_D 。

推荐工作条件

推荐的操作条件表明了器件的真实工作条件。指定推荐的工作条件，以确保器件的最佳性能达到数据表中的规格。飞兆半导体建议不要超过推荐工作条件，也不能按照绝对最大额定值进行设计。

符号	参数	条件	最小值	最大值	单位
V_B	高侧浮动电源电压		$V_S + 10$	$V_S + 20$	V
V_S	高侧浮动电源偏置电压		$6 - V_{DD}$	600	V
V_{DD}	电源电压		10	20	V
V_{HO}	高侧 ($HO1$ 、 $HO2$) 输出电压		V_S	V_B	V
V_{IN}	逻辑输入电压 ($IN1$ 、 $IN2$)		GND	V_{DD}	V
T_A	环境温度		-40	125	$^\circ\text{C}$

电气特性

除非另有说明, $V_{BIAS} (V_{DD}, V_{BS1}, V_{BS2}) = 15.0V$ 、 $T_A = 25^\circ C$ 。 V_{IN} 和 I_{IN} 参数以 GND 作为基准。 V_O 和 I_O 参数以 V_{S1} 和 V_{S2} 作为基准, 适用于各自的输出 HO1 和 HO2。

符号	特性	条件	最小值	典型值	最大值	单位
电源电流部分						
I_{QDD}	V_{DD} 静态电源电流	$V_{IN1} = V_{IN2} = 0V$ 或 $5V$		28	50	μA
I_{PDD}	V_{DD} 工作电源电流	$f_{IN1} = f_{IN2} = 10kHz$, rms value		35	70	μA
自举电源部分						
V_{BSUV+}	V_{BS1} 和 V_{BS2} 电源欠压正向阈值	$V_{BS1} = V_{BS2} =$ 扫描	8.2	9.1	10.2	V
V_{BSUV-}	V_{BS1} 和 V_{BS2} 电源欠压负向阈值	$V_{BS1} = V_{BS2} =$ 扫描	7.6	8.5	9.6	V
V_{BSHYS}	V_{BS1} 和 V_{BS2} 电源欠压锁定滞回电压回差	$V_{BS1} = V_{BS2} =$ 扫描		0.6		V
I_{LK}	偏置电源漏电流	$V_B = V_S = 600V$			10	μA
$I_{QBS1,2}$	V_{BS1} 和 V_{BS2} 静态电源电流	$V_{IN1} = 0V$ 或 $5V$		50	85	μA
$I_{PBS1,2}$	V_{BS1} 和 V_{BS2} 工作电源电流	$f_{IN1} = 10kHz$, rms 值		220	300	μA
栅极驱动器输出部分						
V_{OH}	高电平输出电压, $V_{BIAS} - V_O$	$I_O = 0mA$ (空载)			30	mV
V_{OL}	低电平输出电压, V_O	$I_O = 0mA$ (空载)			30	mV
I_{O+}	输出高电平短路脉冲电流	$V_O = 0V$, $V_{IN} = 5V$, $PW < 10\mu s$	250	350		mA
I_{O-}	输出低电平短路脉冲电流	$V_O = 15V$, $V_{IN} = 0V$, $PW < 10\mu s$	500	650		mA
V_S	IN 信号传播到 H_O 时允许的 V_S 引脚负电压			-9.8	-7.0	V
逻辑输入部分 (HIN 和 LIN)						
V_{IH}	逻辑“1”输入电压		2.5			V
V_{IL}	逻辑“0”输入电压				1.3	V
I_{IN+}	逻辑“1”输入偏置电流	$V_{IN} = 5V$		10	20	μA
I_{IN-}	逻辑“0”输入偏置电流	$V_{IN} = 0V$			2.0	μA
R_{IN}	输入下拉电阻		400	500	600	K Ω

动态电气特性

除非另有说明, $T_A = 25^\circ C$ 、 $V_{BIAS} (V_{DD}, V_{BS1}, V_{BS2}) = 15.0V$ 、 $V_{S1} = V_{S2} = GND$, $C_{Load} = 1000pF$ 。

符号	参数	工作条件	最小值	典型值	最大值	单位
t_{on}	导通传播延时	$V_S = 0V$		110	180	ns
t_{off}	关断传播延时	$V_S = 0V$ 或 $600V^{(5)}$		110	180	ns
t_r	导通上升时间			50	90	ns
t_f	关断下降时间			30	70	ns
MT	延时匹配, 通道 1 和 2 导通 / 关断			0		ns

注意:

5. 该参数由设计保证。

典型特性



图 6. V_{BSUVLO+} 与温度的关系



图 7. V_{BSUVLO-} 与温度的关系

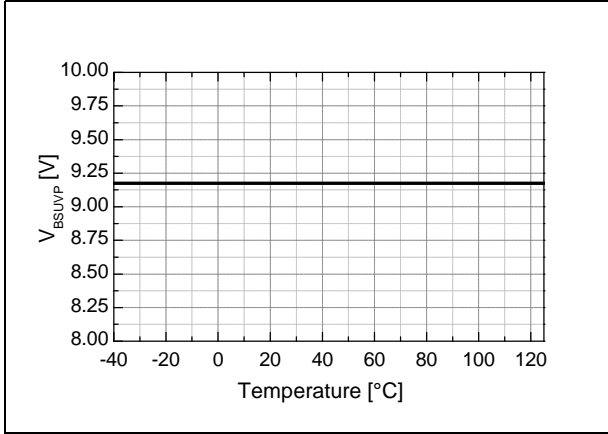

图 8. V_{BSUVLO} 滞回电压回差与温度的关系

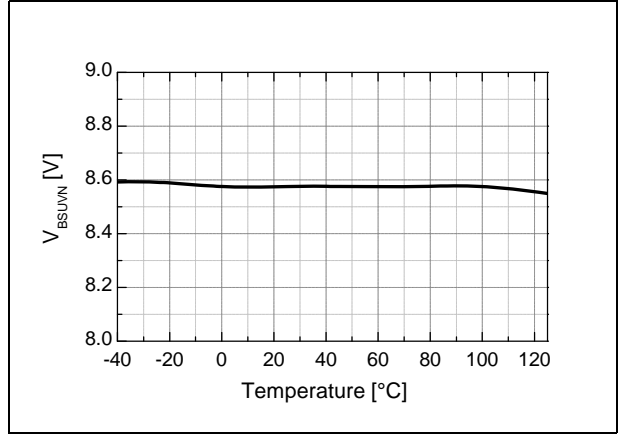

图 9. V_{DD} 静态电流与温度的关系

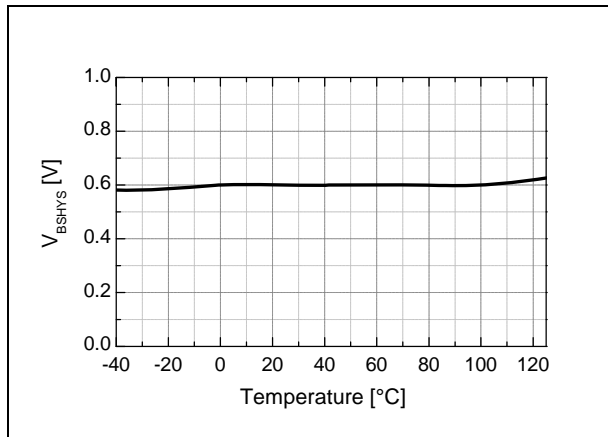

图 10. V_{BS} 静态电流与温度的关系

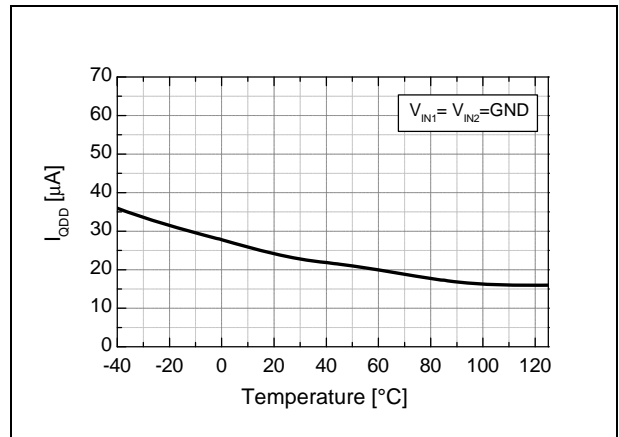

图 11. V_{DD} 工作电流与温度的关系

典型特性 (续)

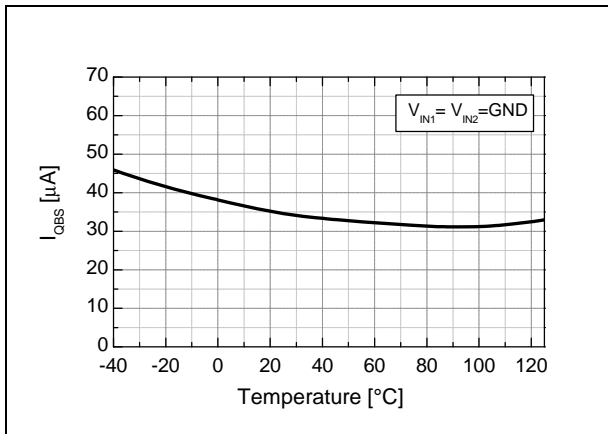

图 12. V_{BS} 工作电流与温度的关系

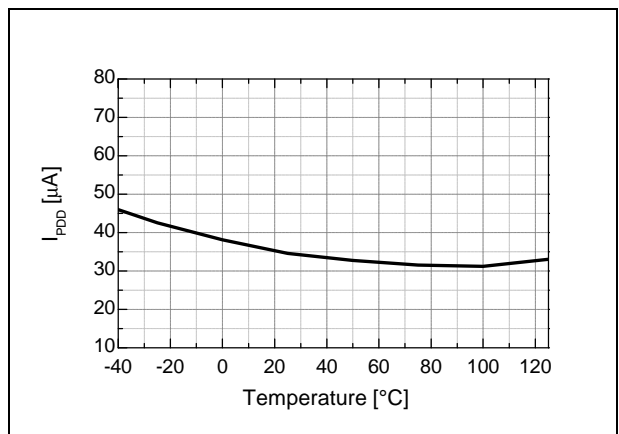

图 13. 逻辑高电平输入电流与温度的关系

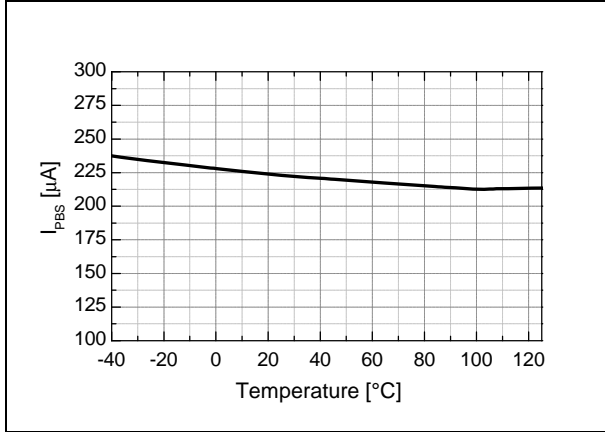

图 14. 逻辑低电平输入电流与温度的关系

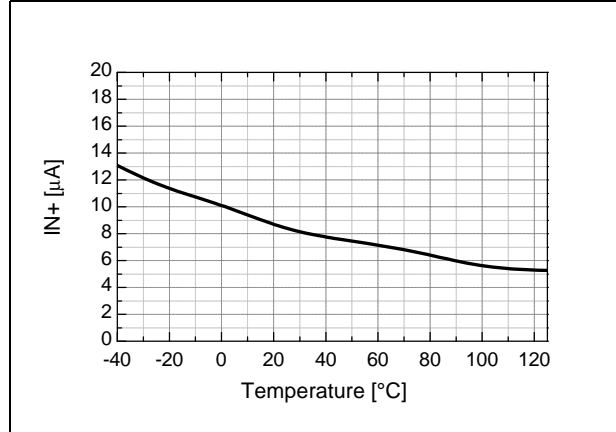

图 15. 逻辑输入高电压与温度的关系

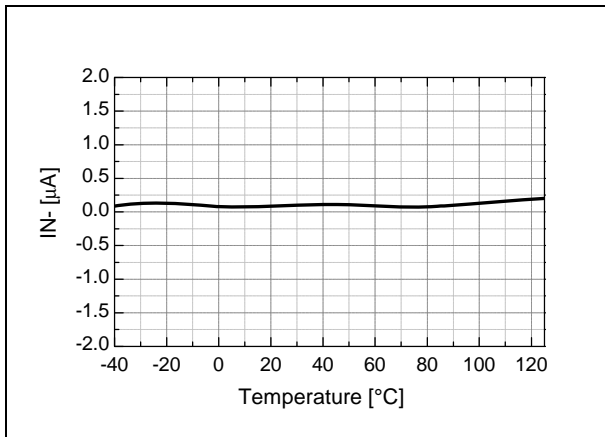

图 16. 逻辑输入低电压与温度的关系

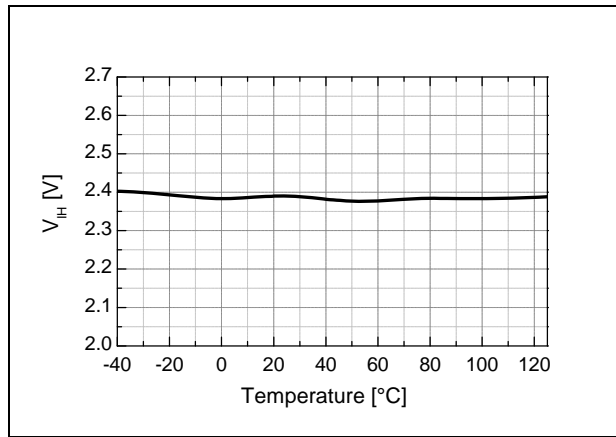

图 17. 逻辑输入电阻与温度的关系

典型特性 (续)

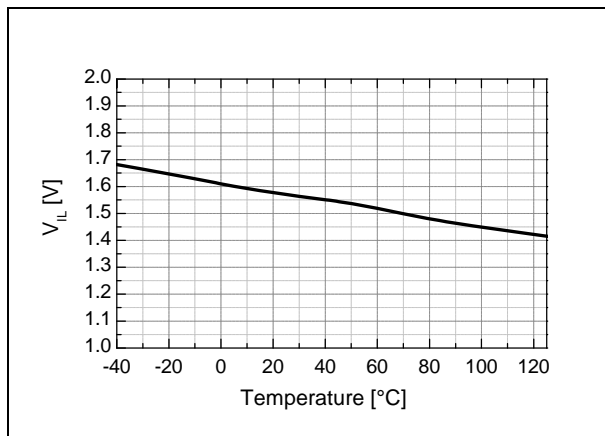

图 18. 上升时间与温度的关系

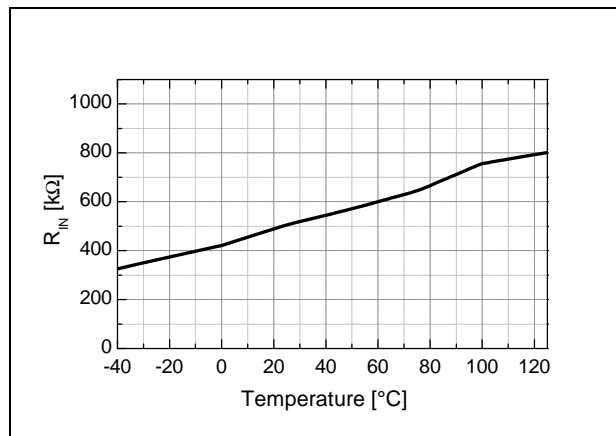

图 19. 下降时间与温度的关系

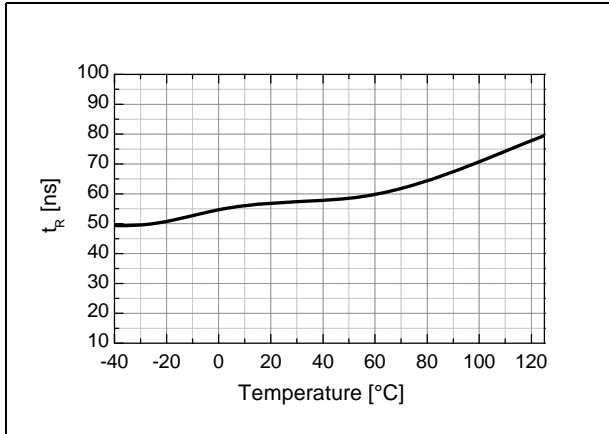

图 20. 导通延时与温度的关系

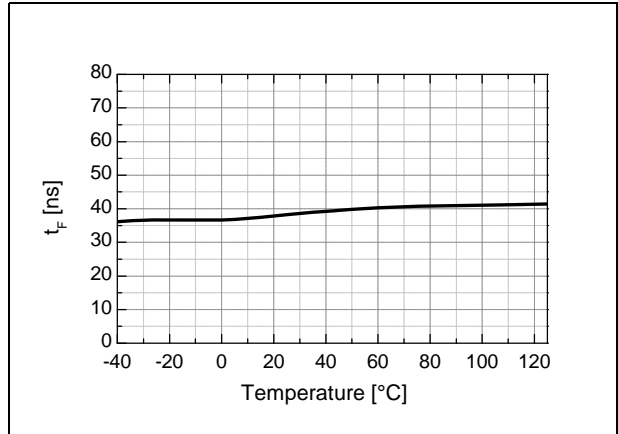

图 21. 关断延时与温度的关系

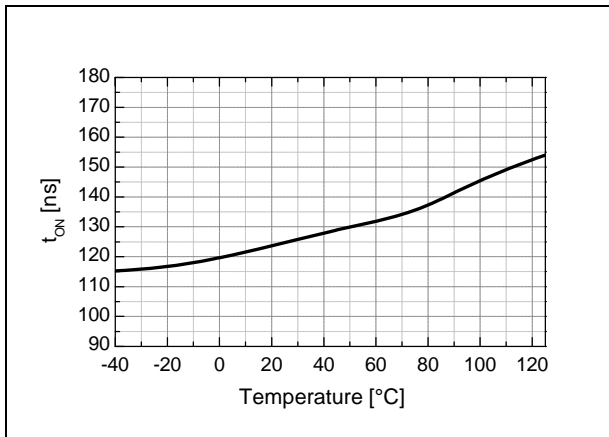

图 22. 延迟匹配时间与温度的关系

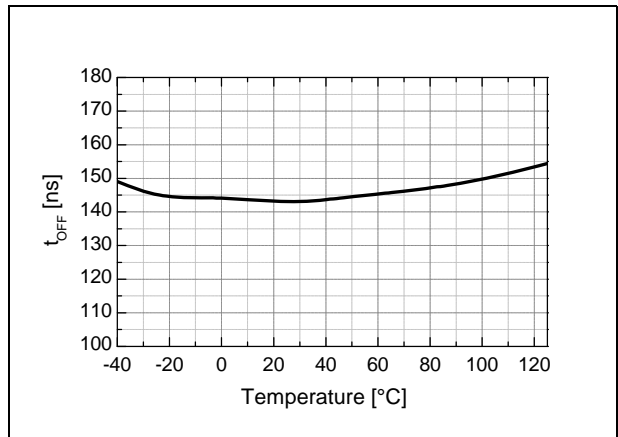

图 23. 信号传播到高侧时允许的 V_S 负电压与温度的关系

典型特性 (续)

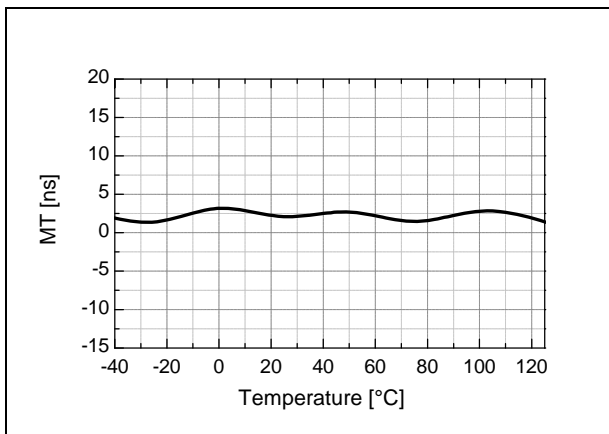

图 24. 输出高电平短路脉冲电流与温度的关系

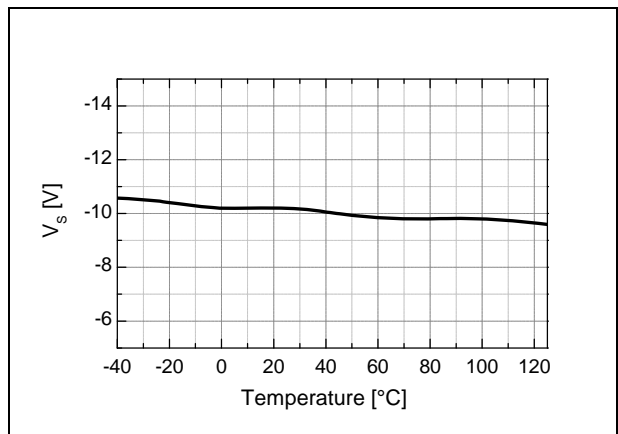

图 25. 输出低电平短路脉冲电流与温度的关系

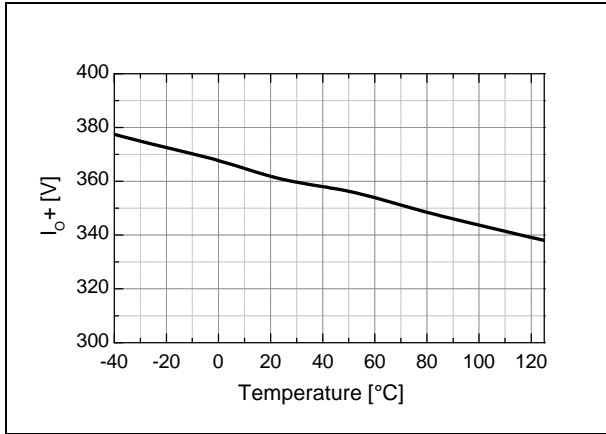

图 26. V_{DD} 静态电流与电源电压的关系

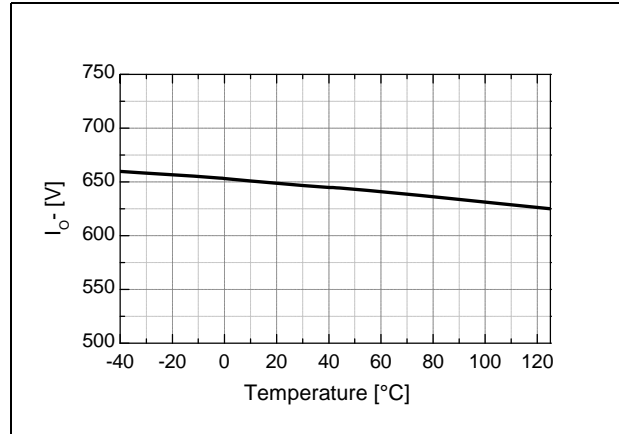

图 27. V_{DD} 工作电流与电源电压的关系

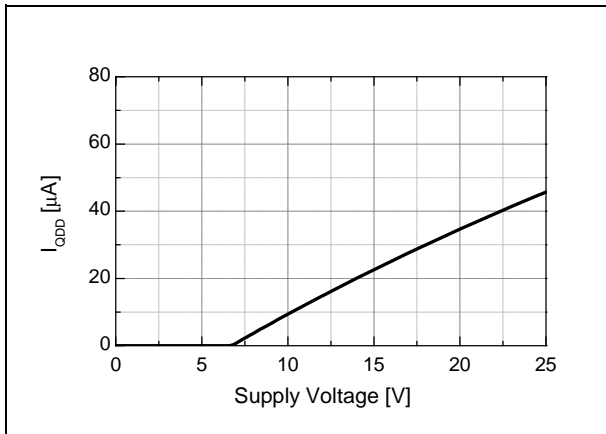

图 28. V_{BS} 工作电流与电源电压的关系

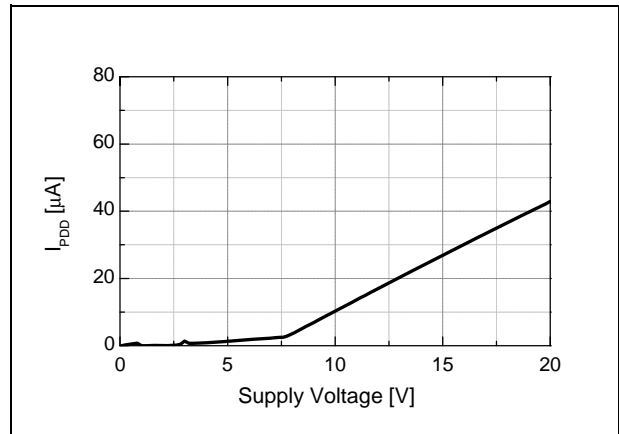

图 29. 上升时间与电源电压的关系

典型特性 (续)

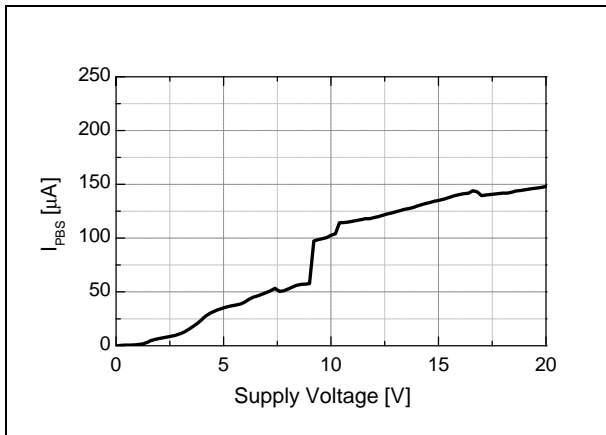

图 30. 下降时间与电源电压的关系

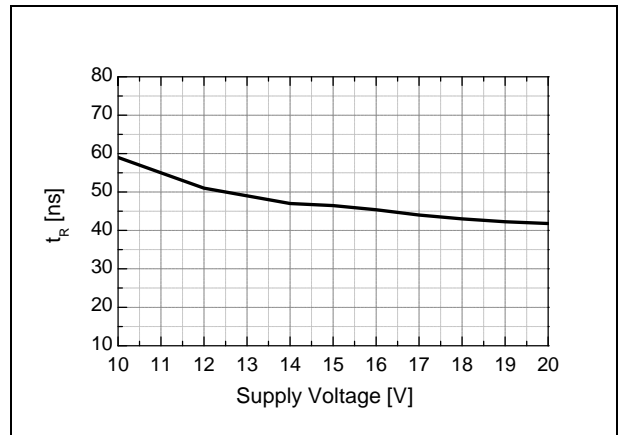

图 31. 导通延时与电源电压的关系

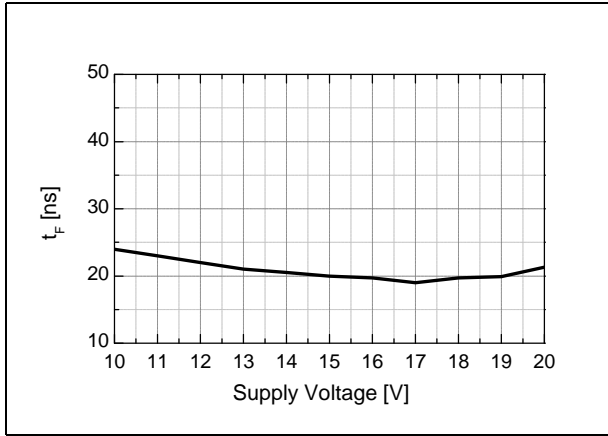

图 32. 关断延时与电源电压的关系

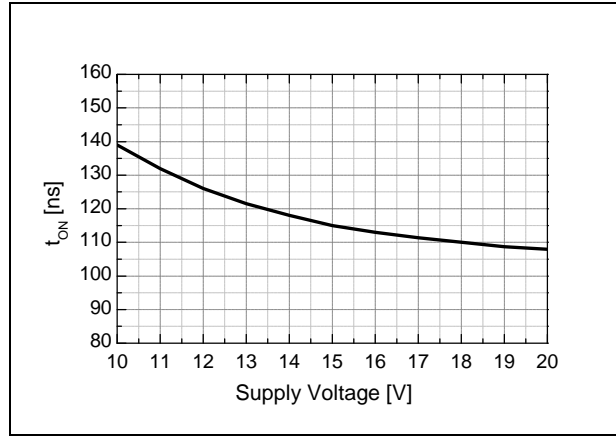

图 33. 输出源电流与电源电压的关系

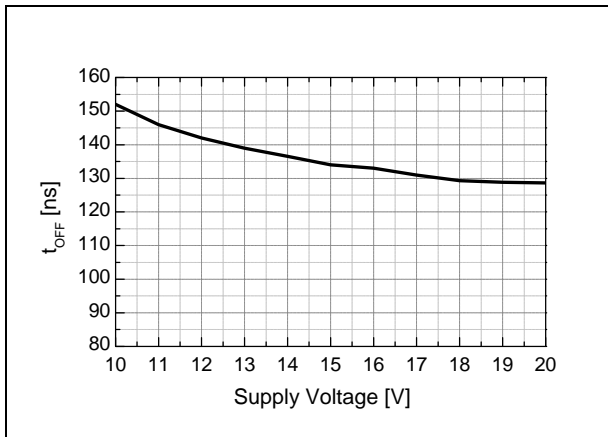

图 34. 输出灌电流与电源电压的关系

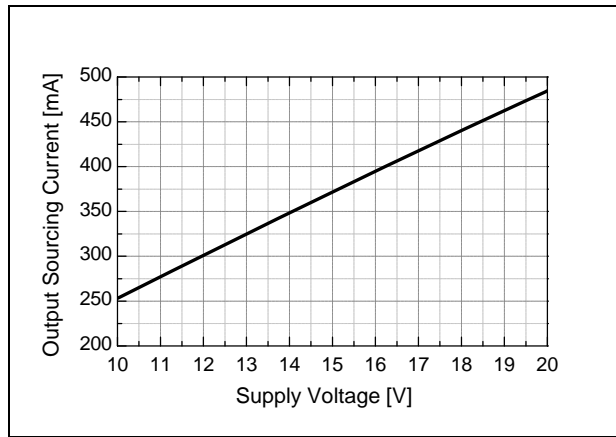

图 35. 信号传播到高侧时允许的 V_S 负电压与电源电压的关系

开关时间定义

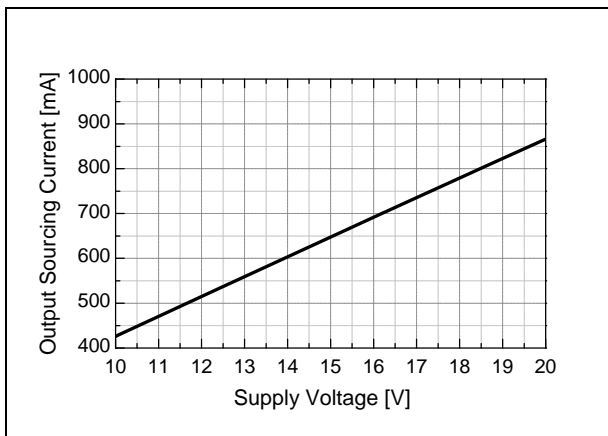

图 36. 开关时间测试电路

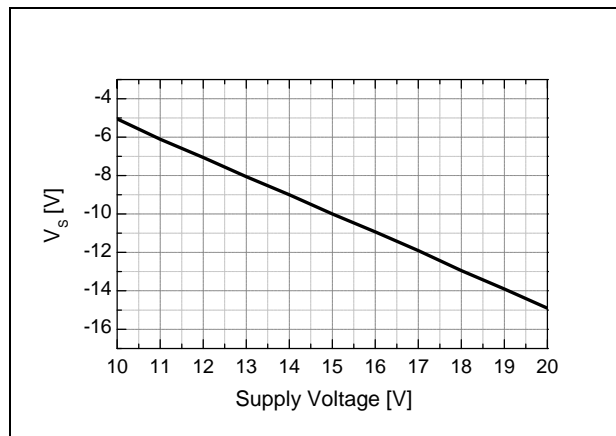

图 37. 输入 / 输出波形

典型应用信息

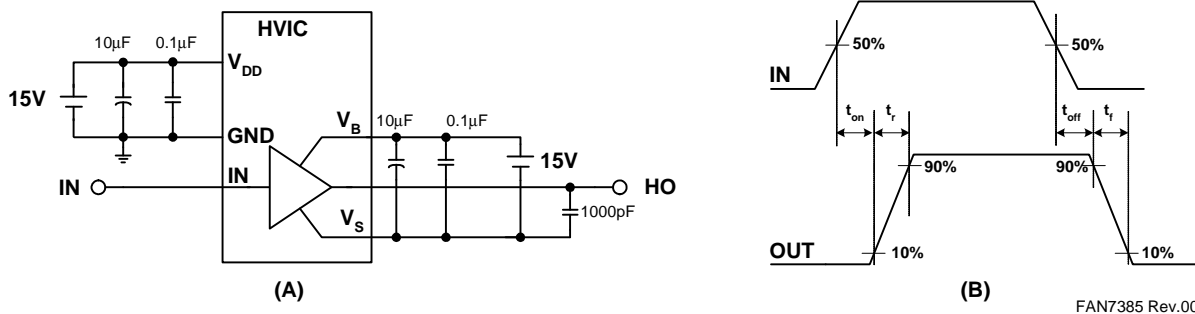
1. 欠压锁定 (UVLO)

FAN7385 有一个欠压锁定 (UVLO) 保护电路, 当 V_{BS1} 和 V_{BS2} 低于指定阈值电压时, 该电路能够防止发生故障。欠压锁定电路单独监控各自自举电容电压 (V_{BS1} 、 V_{BS2})。

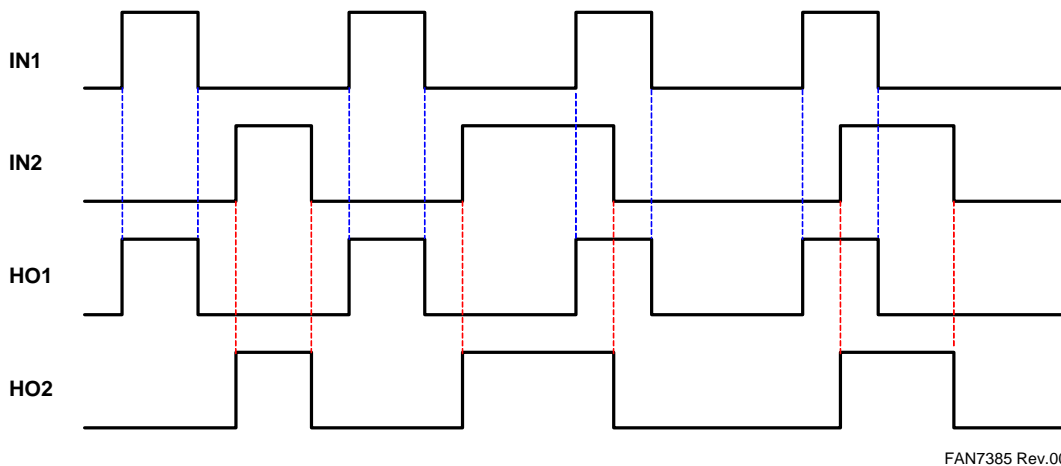
2. 布局思路

为了获得最佳性能, 必须在印制电路板 (PCB) 布局时就进行考虑。

2.1 电源电容

如果输出级能够以大电流值快速导通开关器件, 电源电容必须尽可能靠近器件引脚 (接地电源的 V_{DD} 和 GND、浮动电源的 V_B 和 V_S) 放置, 以最小化寄生电感和电阻。

2.2 栅极驱动环路

电流环路类似天线, 能够接收和发送噪声。为了减少噪声耦合 / 发射并提高电源开关的导通和关断性能, 必须尽量减小栅极驱动环路面积。

2.3 接地层

为了最小化噪声耦合, 避免将接地层置于高侧浮动端的下面或附近。

封装尺寸

14-SOP

除非另有说明，否则尺寸单位为毫米。

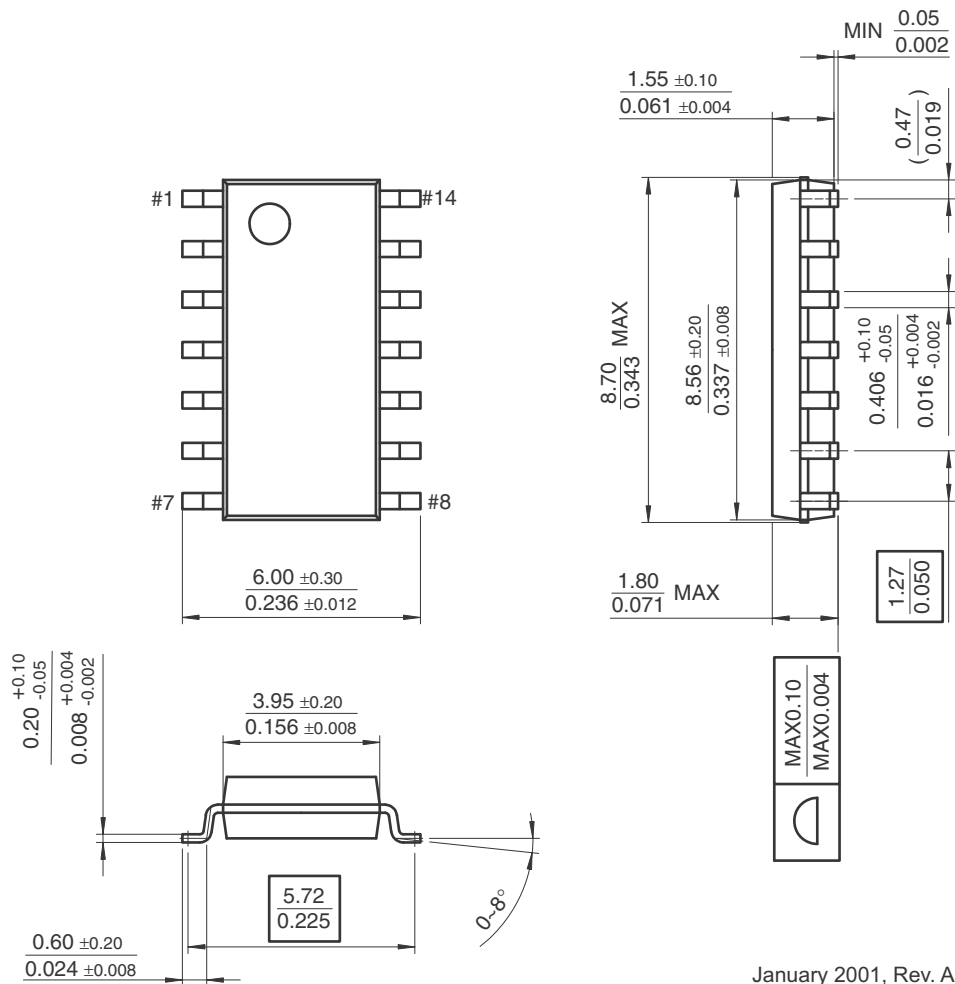

January 2001, Rev. A
14sop225b_dim.pdf

图 38. 14 引脚小尺寸封装 (SOP)



TRADEMARKS

The following are registered and unregistered trademarks Fairchild Semiconductor owns or is authorized to use and is not intended to be an exhaustive list of all such trademarks.

ACE ^x	HiSeC TM	PowerTrench [®]	TinyLogic [®]
Across the board. Around the world. TM	<i>i-Lo</i> TM	Programmable Active Droop TM	TINYOPTO TM
ActiveArray TM	ImpliedDisconnect TM	QFET [®]	TinyPower TM
Bottomless TM	IntelliMAX TM	QS TM	TinyWire TM
Build it Now TM	ISOPLANAR TM	QT Optoelectronics TM	TruTranslation TM
CoolFET TM	MICROCOUPLER TM	Quiet Series TM	μSerDes TM
CROSSVOLT TM	MicroPak TM	RapidConfigure TM	UHC [®]
CTL TM	MICROWIRE TM	RapidConnect TM	UniFET TM
Current Transfer Logic TM	MSX TM	ScalarPump TM	VCX TM
DOME TM	MSXPro TM	SMART START TM	Wire TM
E ² C ^{MOS} TM	OCX TM	SPM [®]	
EcoSPARK [®]	OCXPro TM	SuperFET TM	
EnSigna TM	OPTOLOGIC [®]	SuperSOT TM -3	
FACT Quiet Series TM	OPTOPLANAR [®]	SuperSOT TM -6	
FACT [®]	PACMAN TM	SuperSOT TM -8	
FAST [®]	POP TM	TCM TM	
FASTr TM	Power220 [®]	The Power Franchise [®]	
FPS TM	Power247 [®]	 TM	
FRFET [®]	PowerEdge TM	TinyBoost TM	
GlobalOptoisolator TM	PowerSaver TM	TinyBuck TM	
GTO TM			

DISCLAIMER

FAIRCHILD SEMICONDUCTOR RESERVES THE RIGHT TO MAKE CHANGES WITHOUT FURTHER NOTICE TO ANY PRODUCTS HEREIN TO IMPROVE RELIABILITY, FUNCTION OR DESIGN. FAIRCHILD DOES NOT ASSUME ANY LIABILITY ARISING OUT OF THE APPLICATION OR USE OF ANY PRODUCT OR CIRCUIT DESCRIBED HEREIN; NEITHER DOES IT CONVEY ANY LICENSE UNDER ITS PATENT RIGHTS, NOR THE RIGHTS OF OTHERS. THESE SPECIFICATIONS DO NOT EXPAND THE TERMS OF FAIRCHILD'S WORLDWIDE TERMS AND CONDITIONS, SPECIFICALLY THE WARRANTY THEREIN, WHICH COVERS THESE PRODUCTS.

LIFE SUPPORT POLICY

FAIRCHILD'S PRODUCTS ARE NOT AUTHORIZED FOR USE AS CRITICAL COMPONENTS IN LIFE SUPPORT DEVICES OR SYSTEMS WITHOUT THE EXPRESS WRITTEN APPROVAL OF FAIRCHILD SEMICONDUCTOR CORPORATION.

As used herein:

- Life support devices or systems are devices or systems which, (a) are intended for surgical implant into the body or (b) support or sustain life, and (c) whose failure to perform when properly used in accordance with instructions for use provided in the labeling, can be reasonably expected to result in a significant injury of the user.
- A critical component in any component of a life support, device, or system whose failure to perform can be reasonably expected to cause the failure of the life support device or system, or to affect its safety or effectiveness.

PRODUCT STATUS DEFINITIONS

Definition of Terms

Datasheet Identification	Product Status	Definition
Advance Information	Formative or In Design	This datasheet contains the design specifications for product development. Specifications may change in any manner without notice.
Preliminary	First Production	This datasheet contains preliminary data; supplementary data will be published at a later date. Fairchild Semiconductor reserves the right to make changes at any time without notice to improve design.
No Identification Needed	Full Production	This datasheet contains final specifications. Fairchild Semiconductor reserves the right to make changes at any time without notice to improve design.
Obsolete	Not In Production	This datasheet contains specifications on a product that has been discontinued by Fairchild Semiconductor. The datasheet is printed for reference information only.

Rev. I23

ON Semiconductor and  are trademarks of Semiconductor Components Industries, LLC dba ON Semiconductor or its subsidiaries in the United States and/or other countries. ON Semiconductor owns the rights to a number of patents, trademarks, copyrights, trade secrets, and other intellectual property. A listing of ON Semiconductor's product/patent coverage may be accessed at www.onsemi.com/site/pdf/Patent-Marking.pdf. ON Semiconductor reserves the right to make changes without further notice to any products herein. ON Semiconductor makes no warranty, representation or guarantee regarding the suitability of its products for any particular purpose, nor does ON Semiconductor assume any liability arising out of the application or use of any product or circuit, and specifically disclaims any and all liability, including without limitation special, consequential or incidental damages. Buyer is responsible for its products and applications using ON Semiconductor products, including compliance with all laws, regulations and safety requirements or standards, regardless of any support or applications information provided by ON Semiconductor. "Typical" parameters which may be provided in ON Semiconductor data sheets and/or specifications can and do vary in different applications and actual performance may vary over time. All operating parameters, including "Typicals" must be validated for each customer application by customer's technical experts. ON Semiconductor does not convey any license under its patent rights nor the rights of others. ON Semiconductor products are not designed, intended, or authorized for use as a critical component in life support systems or any FDA Class 3 medical devices or medical devices with a same or similar classification in a foreign jurisdiction or any devices intended for implantation in the human body. Should Buyer purchase or use ON Semiconductor products for any such unintended or unauthorized application, Buyer shall indemnify and hold ON Semiconductor and its officers, employees, subsidiaries, affiliates, and distributors harmless against all claims, costs, damages, and expenses, and reasonable attorney fees arising out of, directly or indirectly, any claim of personal injury or death associated with such unintended or unauthorized use, even if such claim alleges that ON Semiconductor was negligent regarding the design or manufacture of the part. ON Semiconductor is an Equal Opportunity/Affirmative Action Employer. This literature is subject to all applicable copyright laws and is not for resale in any manner.

PUBLICATION ORDERING INFORMATION

LITERATURE FULFILLMENT:

Literature Distribution Center for ON Semiconductor
19521 E. 32nd Pkwy, Aurora, Colorado 80011 USA
Phone: 303-675-2175 or 800-344-3860 Toll Free USA/Canada
Fax: 303-675-2176 or 800-344-3867 Toll Free USA/Canada
Email: orderlit@onsemi.com

N. American Technical Support: 800-282-9855 Toll Free
USA/Canada
Europe, Middle East and Africa Technical Support:
Phone: 421 33 790 2910
Japan Customer Focus Center
Phone: 81-3-5817-1050

ON Semiconductor Website: www.onsemi.com
Order Literature: <http://www.onsemi.com/orderlit>
For additional information, please contact your local
Sales Representative