

General

- Slow Blow
- 1.6mm× 0.8mm physical size
- Thick film manufacturing method, ceramic substrate, silver fusing element
- -55℃~125℃ operating temperature
- Excellent environmental integrity
- RoHS compliant
- Halogen-free
- Lead free

Agency / Certificate Information

Agency	File Number	Ampere Range
	E319512	0.5A~8A

Application

- Battery pack
- PC related equipment and peripherals (Hard driver, Printer, etc.)
- Digital camera (Digital still camera)
- Game equipment
- LCD monitor, LCD modules
- Wireless base station
- Power supply
- Medical device

Electrical Specifications

Part Number	Marking	Current Rating (A)	Voltage Rating (V)	Interrupting Rating (V)	Typical Cold DCR* (mΩ)	Typical I ² T** (A ² s)
S0603-S-0.5A	F	0.5	63	50A 32V DC	870	0.0068
S0603-S-0.75A	G	0.75	63		389	0.0177
S0603-S-1.0A	H	1.0	32		235	0.0746
S0603-S-1.5A	K	1.5	32		93	0.1125
S0603-S-2.0A	N	2.0	32		47	0.1752
S0603-S-2.5A	O	2.5	32		31	0.4001
S0603-S-3.0A	P	3.0	32		23	0.7329
S0603-S-3.5A	R	3.5	32		19	0.9758
S0603-S-4.0A	S	4.0	32	35A 32V DC	13	2.1722
S0603-S-5.0A	T	5.0	32		8.7	3.3128
S0603-S-6.0A	6	6.0	32	50A 32V DC	6.3	7.8480
S0603-S-7.0A	U	7.0	32		5.8	8.5120
S0603-S-8.0A	8	8.0	32		5.2	10.5388

* Measured at ≤10% rated current and 25℃

** Melting I²T at 10 times of rated current

Part Number Information

S 0603-S-1.0A

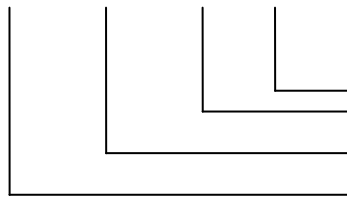

- “1.0A” Ampere Rating: 1A
- “S” Electrical Characteristic: S = Slow blow
- “0603” Size Number
- “S” Symbol of SART

Dimensions

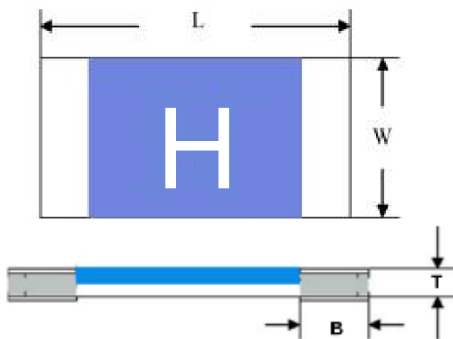

Type	L (mm)	W (mm)	T (mm)	B (mm)
S0603-S	1.60±0.15	0.80±0.15	0.40±0.10	0.30±0.20

Recommended Land Patterns

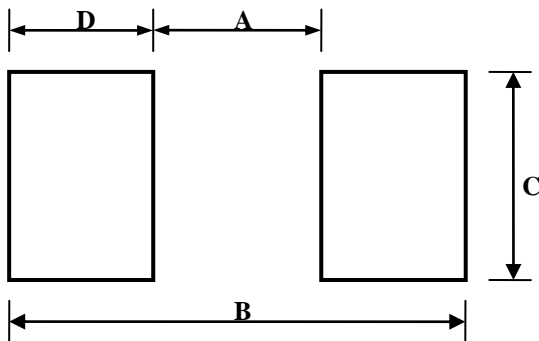

Dimensions	A(mm)	B(mm)	C(mm)	D(mm)
Spec	1.00±0.20	3.00±0.50	1.40±0.20	1.00±0.30

Materials

Components	Material
Body	Ceramic
Terminations	Silver over plated with tin (100%)
Element	Silver or Silver/Palladium

Dimensions of Standard Test Board

Type	Ampere Rating	Board Thickness (mm)	Copper Layer Thickness (mm)	Copper Trace Width (mm)
S0603-S	0.5A~6.0A	1.6	0.035	5.0
	7.0A~8.0A	1.6	0.070	7.5

Time Current Curve

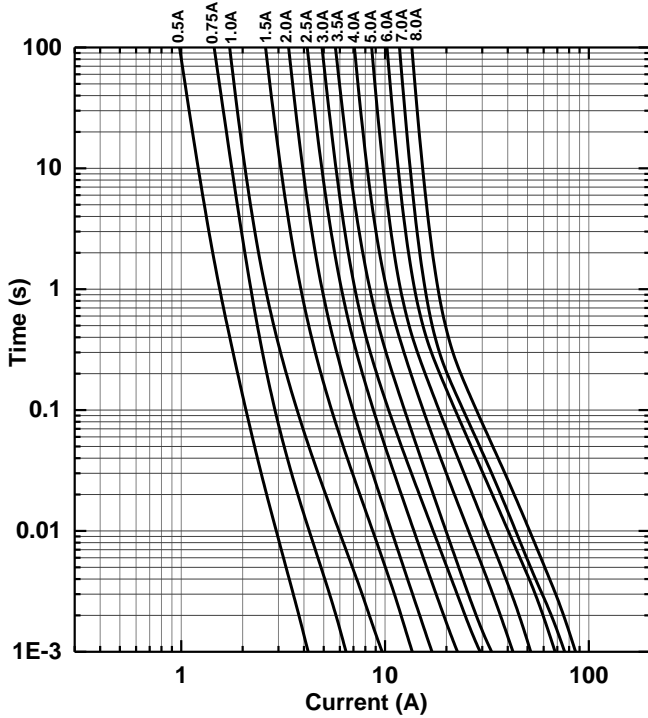

I^2T VS Time Curve

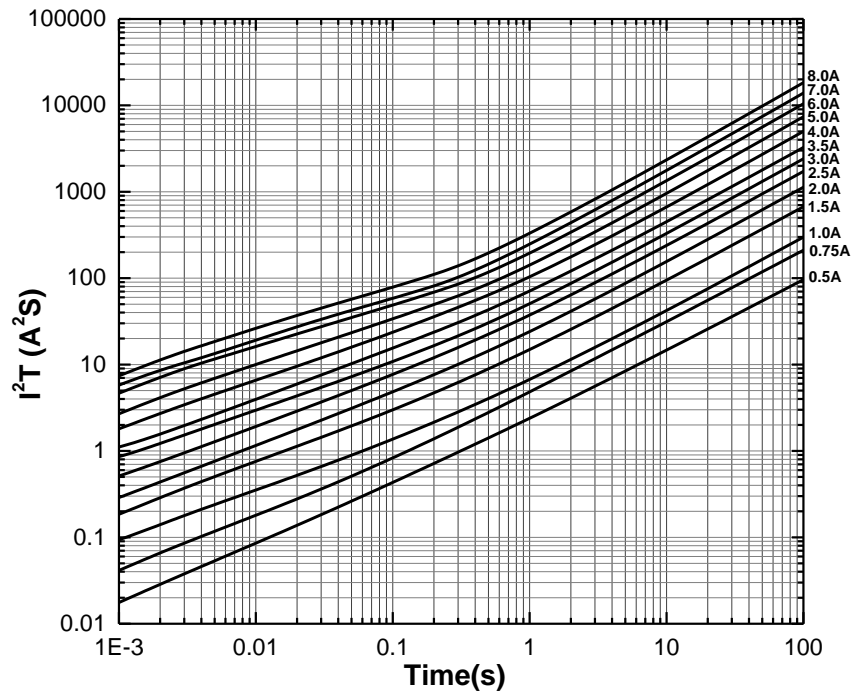

Electrical Characteristics

Type	Ampere Rating	% of Current Rating	Opening Time
S0603-S	0.5A~8.0A	100	>4hours
	1.0A~8.0A	200	≤60sec
	0.5A~0.75A	250	≤20sec
	0.5A~0.75A	1000	>0.1ms
	1.0A~3.0A	1000	>0.3ms
	3.5A~8.0A	1000	>0.6ms

Temperature Derating Curve

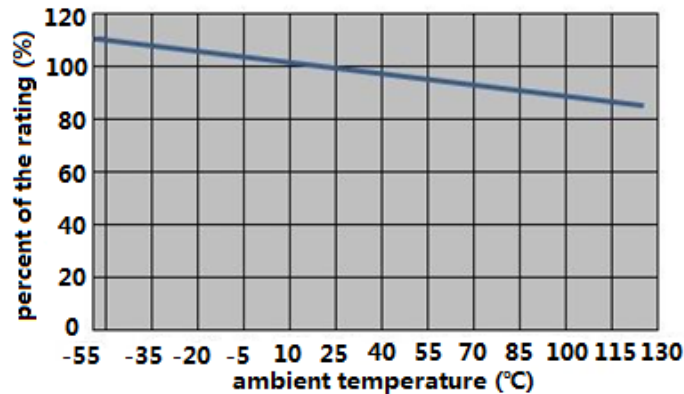

Product Characteristics

Recommended Solder Curve

Time/Current	100% of current rating	No Fusing, 4hours Min.	UL248-14
	200% of current rating	1.0A~8.0A: ≤60sec	SART SPEC.
	250% of current rating	0.5A~0.75A: ≤20sec	
	1000% of current rating	0.5A~0.75A: >0.1ms 1.0A~3.0A: >0.3ms 3.5A~8.0A: >0.6ms	
Voltage Drop	100% of current rating	Deviation between the mean value: <15%	IEC60127-4
Temperature Rise	100% of current rating	$\Delta T < 75^{\circ}\text{C}$	IEC60127-4
Endurance Test	100 cycles of 1In for 1h "ON", for 15min "OFF", then following by 1h at 125%In	$ \Delta R < 10\%$	IEC60127-4
Interrupting Ability	0.5A~3.5A: 50A 32V DC 4.0A~6.0A: 35A 32V DC 7.0A~8.0A: 50A 32V DC	without permanent arcing, ignition and bursting of fuse link	UL248-14 IEC60127-4
Solderability	$240^{\circ}\text{C} \pm 5^{\circ}\text{C}$, 3sec ± 0.5 sec	95% coverage Min.	IEC60127-4 MIL-STD-202 Method 208
Resistance to Soldering	$260^{\circ}\text{C} \pm 5^{\circ}\text{C}$, 10sec ± 0.5 sec	$ \Delta R < 10\%$ Legible appearance	MIL-STD-202 Method 210
Bending Test	Distance between holding points: 90mm Bending: 1mm, time: 10s	$ \Delta R < 10\%$ No mechanical damages	IEC60127-4
High Temperature Operating Life	$T = 70^{\circ}\text{C} \pm 2^{\circ}\text{C}$, 60%In, 96hours	$ \Delta R < 10\%$; No fusing	MIL-STD-202 Method 108
Humidity (Steady State)	$T = 40^{\circ}\text{C} \pm 2^{\circ}\text{C}$, 90%~95%RH, 1000hours	$ \Delta R < 10\%$	MIL-STD-202 Method 103
Low Temperature Storage	$T = -55^{\circ}\text{C} \pm 3^{\circ}\text{C}$, 96hours	$ \Delta R < 10\%$	IEC60068-2-1
High Temperature Storage	$T = 125^{\circ}\text{C} \pm 2^{\circ}\text{C}$, 96hours	$ \Delta R < 10\%$	IEC60068-2-2
Salt Spray	5% salt solution, 48hours	$ \Delta R < 10\%$ Legible appearance	MIL-STD-202 Method 101
Thermal Shock	100 cycles between $-65^{\circ}\text{C}/+125^{\circ}\text{C}$ 60 minutes, each extreme	$ \Delta R < 10\%$ No mechanical damages	MIL-STD-202 Method 107

1. Infrared Reflow:
- Temperature: 260°C
 - Time: 5sec Max.
 - Recommend Reflow profile

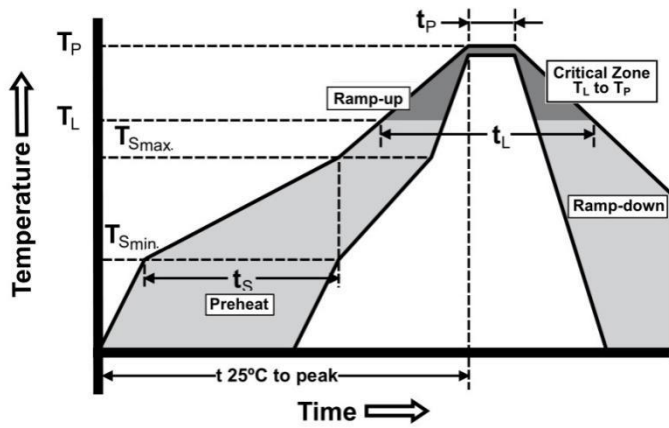

Profile Feature	Pb-Free Assembly
Average Ramp-up Rate(T_{Smax} to T_p)	3°C/sec Max.
Preheat Temperature Min.(T_{Smin}) Temperature Max.(T_{Smax}) Time(T_{Smin} to T_{Smax})	150°C 200°C 60sec~120sec
Peak Temperature(T_p)	260°C
Time within 5°C of actual Peak Temperature(T_p)	5sec
Melting tin time(T_L)	20sec~30sec
Ramp-down Rate	6°C/sec Max.
Time 25°C to peak Temperature	8minutes Max.

2. Wave soldering
- Reservoir Temperature: 260°C
 - Time in Reservoir: 10secMax.

- 3.Hand Soldering
- Temperature: 350°C
 - Time: 5secMax.

Packaging

- 5000 pieces of fuses in emboss taper and reeled on a 178mm(7 inch) reel.

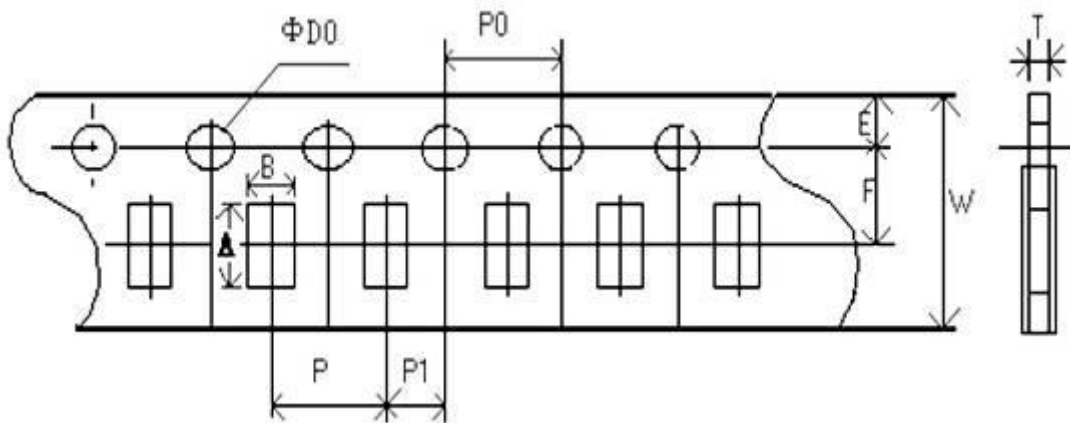

Type	A(mm)	B(mm)	W(mm)	E(mm)	F(mm)
Spec	1.85±0.10	1.10±0.10	8.00±0.20	1.75±0.10	3.50±0.05
Type	P(mm)	P0(mm)	P1(mm)	D0(mm)	T(mm)
Spec	4.00±0.10	4.00±0.10	2.00±0.05	1.50±0.10	0.60±0.10



Type	M(mm)	W(mm)	T(mm)	A(mm)	B(mm)	C(mm)	D(mm)
Spec	178.00±2.00	9.50±1.00	12.50±1.50	2.00±0.50	13.00±0.50	21.00±0.50	58.00±2.00

Storage

- The ambient temperature recommended for storage shall be between 5°C~30°C
- The relative humidity recommended for storage shall be between 25%RH~60%RH
- Sealed plastic bags with desiccant shall be used to reduce the oxidation of the termination and shall only be opened prior to use
- The products shall not be stored in areas where harmful gases containing sulfur or chlorine are present