

Description

The AUR9801D is a highly-integrated battery charger for single-cell Li-ion or Li-polymer batteries capable of operating with an input voltage reached 2.5V. It is a complete charger device designed to work with an USB port or 5V output AC adapter.

The AUR9801D operates with CC (constant current) mode and CV (constant voltage) mode profiles. A low-current preconditioning charge mode is also provided as a trickle charging operation. The charge current is programmable up to 1A with an external resistor or a logic input. The charge voltage is 0.6% accurate over the full application range.

When operating with a current-limited adapter, the charger minimizes the thermal dissipation with pulsed operations to prevent overheat conditions that is commonly occurred with conventional linear chargers. The AUR9801D reduces charge current for thermal fold-back to ensure product safe operation. The charger automatically re-charges the battery when the battery voltage drops below a recharge threshold. The chip includes a safety timer for setting the fast charge time limit in case of charging a dead battery.

Additional features include preconditioning of an over-discharged battery and charging the battery in a safe temperature range with an NTC thermistor interface. The thermally enhanced DFN package is offered for space limited handheld applications.

The AUR9801D is available in WDFN-3X3-10 package.

Features

- Complete Charger for Single-Cell Li-ion Batteries
- Charges from either AC Adapter or USB Port
- Integrated Power Pass Device with Current Sensing
- No External Blocking Diode Required
- Pre-charge Condition with Safety Timing
- Charger Voltage Accuracy: 0.6%
- Programmable Current Limit up to 1A
- Sleep Mode for Power Saving
- Charge Current Thermal Fold-back
- NTC Thermistor Interface for Battery Temperature Monitor
- Stand-Alone or Integrated Charger
- Ambient Temperature Range: -40°C to +85°C
- **Totally Lead-free & Fully RoHS Compliant (Notes 1 & 2)**
- **Halogen and Antimony Free. "Green" Device (Note 3)**

Notes: 1. No purposely added lead. Fully EU Directive 2002/95/EC (RoHS), 2011/65/EU (RoHS 2) & 2015/863/EU (RoHS 3) compliant.
 2. See <https://www.diodes.com/quality/lead-free/> for more information about Diodes Incorporated's definitions of Halogen- and Antimony-free, "Green" and Lead-free.
 3. Halogen- and Antimony-free "Green" products are defined as those which contain <900ppm bromine, <900ppm chlorine (<1500ppm total Br + Cl) and <1000ppm antimony compounds.

Pin Assignments

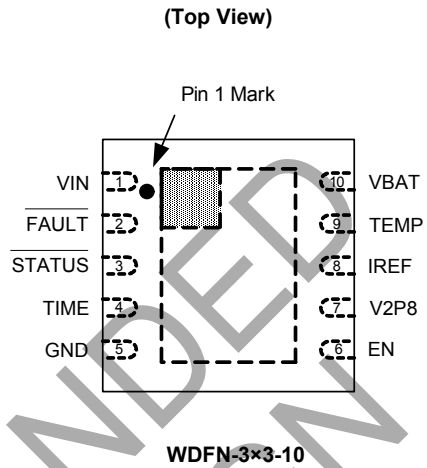

Applications

- PDAs, Cell Phones and Smart Phones
- Digital Camera, MP3 and Handheld Gaming
- Portable Instruments including Medical Handhelds
- Self-Charging Battery Packs
- Stand-Alone Chargers or USB Port Chargers

Typical Applications Circuit

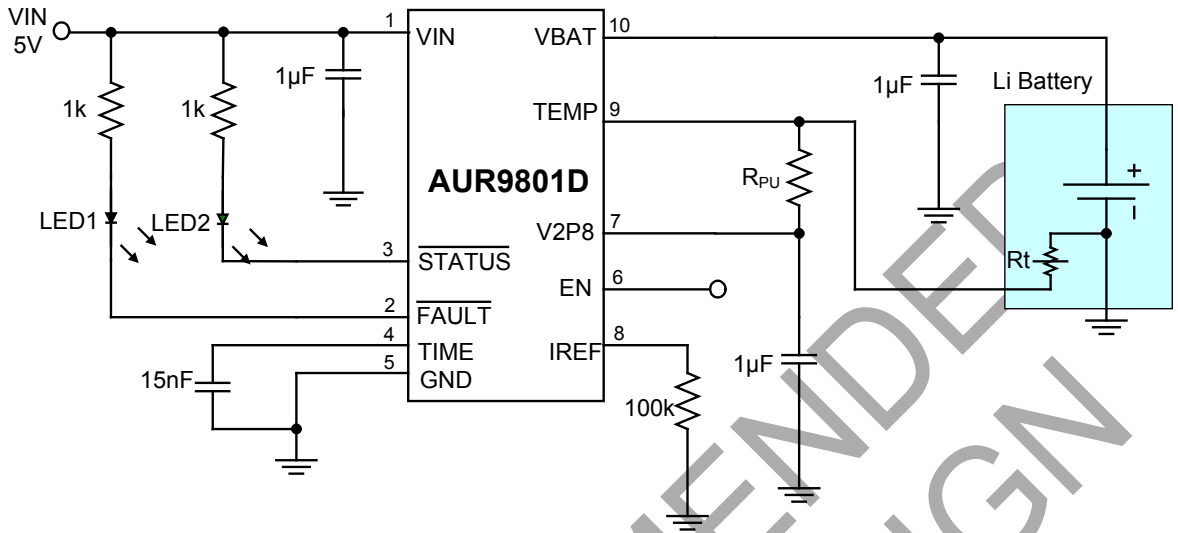

Figure 1. Typical Application of AUR9801D

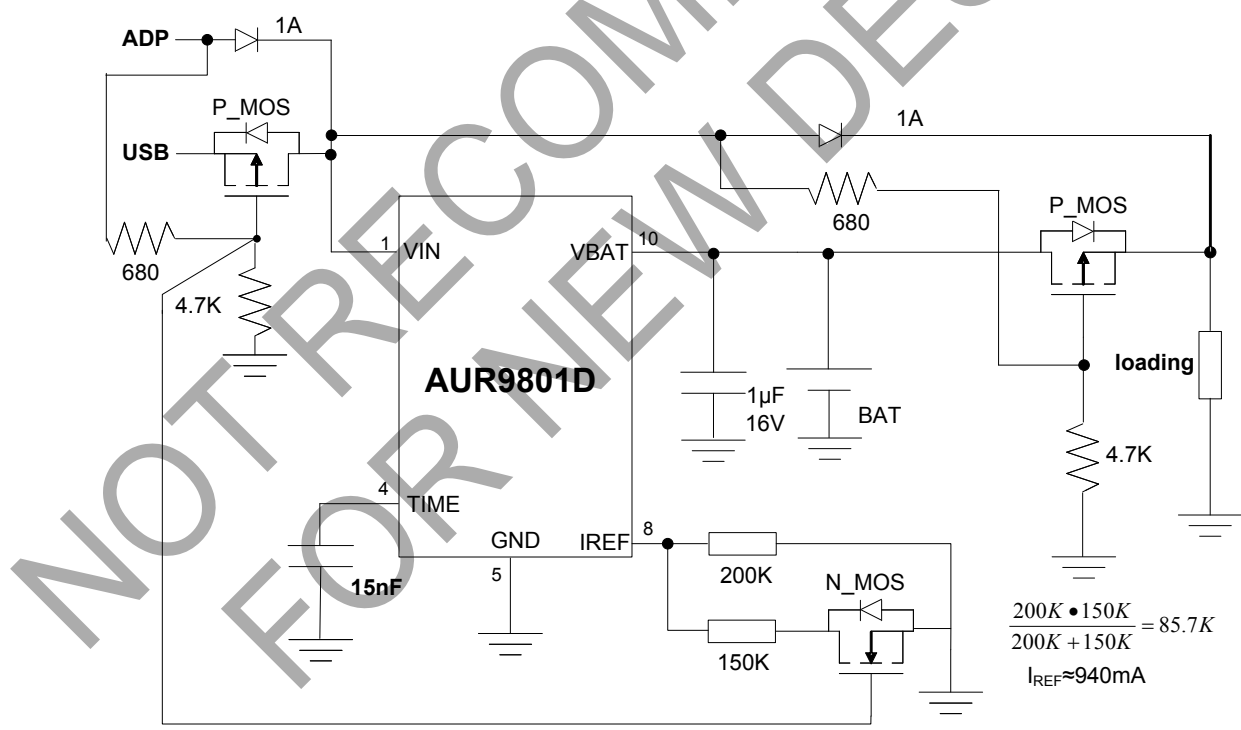
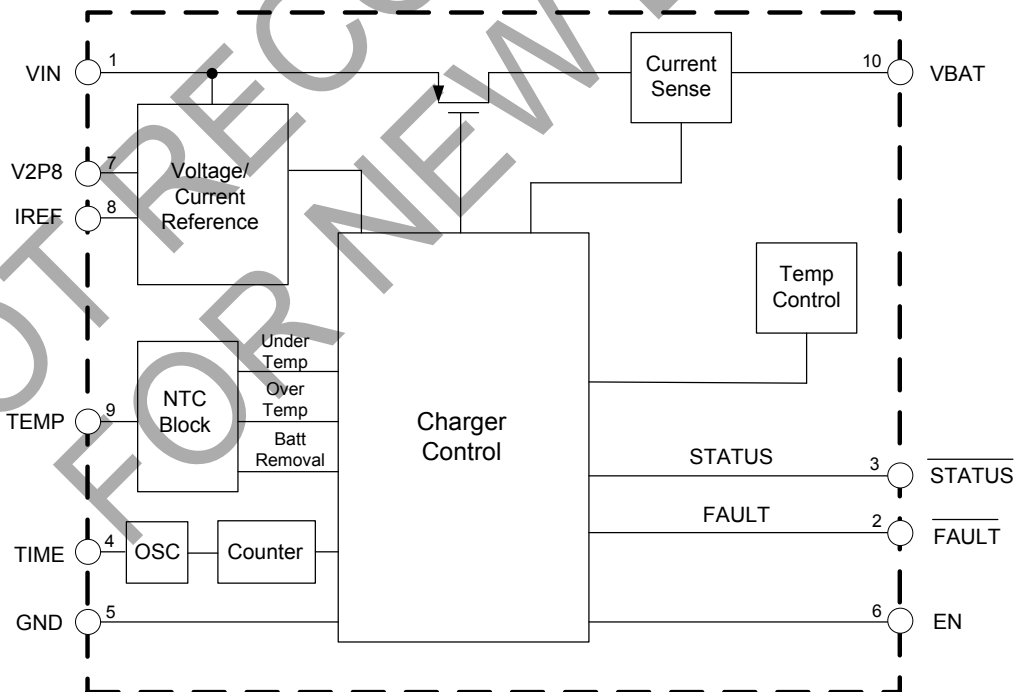

Figure 2. External Power Path Application Circuit

Pin Descriptions

Pin Number	Pin Name	Pin Type	Pin Function
1	VIN	POWER	Charger input supply voltage
2	$\overline{\text{FAULT}}$	O	Active-low, open-drain output, capable of sinking 5mA current
3	$\overline{\text{STATUS}}$	O	Open-drain pin to show charging and Inhibit states, capable of sinking 5mA current
4	TIME	I	Timing capacitor pin for connecting a capacitor to set internal clocking and charger time reference
5	GND	GROUND	Ground pin
6	EN	I	Chip enable control, high to activate the chip with internal 800k Ω pull-up resistor
7	V2P8	O	2.8V reference voltage output, capable of driving up to 2mA
8	IREF	I	A resistor can be connected at this pin to set the charge current
9	TEMP	I	Battery Temperature input for NTC thermistor input, can be used for battery removal detection
10	VBAT	O	Connection to the battery positive node
	Thermal pad		Connected with ground

Functional Block Diagram



Absolute Maximum Ratings (Note 4)

Symbol	Parameter	Value	Unit
V_{IN}	Supply Input Voltage	-0.3 to 6.5	V
V_{EN}	Enable Input Voltage	-0.3 to $V_{IN}+0.3$	V
V_{BAT}	Output Voltage	-0.3 to $V_{IN}+0.3$	V
—	Other Pin Voltage (<u>FAULT</u> , <u>STATUS</u> , <u>TIME</u> , <u>TEMP</u> , <u>IREF</u> , <u>V2P8</u>)	-0.3 to $V_{IN}+0.3$	V
θ_{JA}	Thermal Resistance (Simulation)	45.13	°C/W
T_J	Operating Junction Temperature	+160	°C
T_{STG}	Storage Temperature	-65 to +150	°C

Note: 4. Stresses greater than those listed under "Absolute Maximum Ratings" may cause permanent damage to the device. These are stress ratings only, and functional operation of the device at these or any other conditions beyond those indicated under "Recommended Operating Conditions" is not implied. Exposure to "Absolute Maximum Ratings" for extended periods may affect device reliability.

Recommended Operating Conditions

Symbol	Parameter	Min	Max	Unit
V_{IN}	Supply Voltage	4.6	5.5	V
T_A	Ambient Temperature Range	-40	+85	°C

Electrical Characteristics ($V_{IN}=5V$ and $T_A=+25^{\circ}C$ for the typical values. The maximum and minimum values are over $-40^{\circ}C$ to $+85^{\circ}C$ ambient temperature with a supply voltage in the range of 4.6V to 5.5V, unless otherwise noted.)

Symbol	Parameter	Test Condition	Min	Typ	Max	Unit
Power-on Reset						
—	VIN Rising Voltage	—	3.2	3.6	3.9	V
—	VIN Falling Voltage	—	2.25	2.5	2.7	V
Standby Current						
I _{STANDBY}	VBAT Pin Sink Current	VIN floating or EN=LOW	—	—	3.3	μA
I _{IN}	VIN Pin Supply Current	VBAT floating and EN pulled low	—	—	150	μA
		VBAT and EN floating	—	—	1	mA
VIN-VBAT Offset Voltage						
V _{OS}	Offset Voltage	V _{BAT} =4.2V, I _{BAT} = 20mA, use STATUS pin	45	80	100	mV
Voltage Regulation						
V _{BAT}	Output Voltage	Tested at 50mA load, 5V input, and +25°C	4.175	4.2	4.225	V
—	Dropout Voltage	V _{BAT} =4.0V, charge current = 0.35A	—	175	—	mV
Charge Current						
I _{CHG}	Constant Charge Current	R _{REF} =100kΩ, V _{BAT} =3.0V to 4.0V	760	800	840	mA
I _{TRICKLE}	Trickle Charge Current	R _{REF} =100kΩ, V _{BAT} =2.5V	—	120	—	mA
I _{MIN}	End-of-Charge Threshold	R _{REF} =100kΩ	70	80	90	mA
V2P8 Pin Output						
V _{2P8}	V2P8 Pin Output Voltage	Load current less than 1mA	2.8	2.9	3.0	V
Recharge Threshold						
V _{RECHG}	Recharge Threshold	—	3.97	4.05	4.13	V
V _{RECHG-HYS}	Recharge Threshold Hysteresis	—	—	50	—	mV
Trickle Charge Threshold						
V _{MIN}	Trickle Threshold Voltage	—	2.7	2.8	2.9	V
V _{MINHYS}	Trickle Threshold Hysteresis	—	50	100	150	mV

Electrical Characteristics (Cont. $V_{IN}=5V$ and $T_A=+25^{\circ}C$ for the typical values. The maximum and minimum values are over $-40^{\circ}C$ to $+85^{\circ}C$ ambient temperature with a supply voltage in the range of 4.6V to 5.5V, unless otherwise noted.)

Symbol	Parameter	Test Condition	Min	Typ	Max	Unit
Temperature Monitoring						
V_{TMAX}	High Voltage Threshold	$V_{2P8}=3.0V$	—	2.0	—	V
—	High Voltage Threshold Hysteresis	$V_{2P8}=3.0V$	—	1.9	—	V
V_{TMIN}	Low Voltage Threshold	$V_{2P8}=3.0V$	—	1	—	V
—	Low Voltage Threshold Hysteresis	$V_{2P8}=3.0V$	—	1.1	—	V
T_{FOLD}	Thermal Foldback Threshold	—	—	+107	—	$^{\circ}C$
Oscillator						
f_{OSC}	Oscillation Frequency	$C_{TIME}=15nF$	305	333	370	Hz
Logic Input and Output						
—	EN Pin Logic Input High	—	2.0	—	—	V
—	EN Pin Logic Input Low	—	—	—	0.8	V
—	EN Pin Internal Pull-Up	—	—	800	—	k Ω
—	\overline{STATUS} , \overline{FAULT} Output Voltage	10mA Current	—	—	0.8	V

NOT RECOMMENDED FOR NEW DESIGN

Performance Characteristics ($V_{IN}=5V$, $T_A=+25^{\circ}C$, $R_{IREF}=100k\Omega$, $V_{BAT}=3.7V$, unless otherwise noted.)

Charge Output Voltage vs. Charge Current

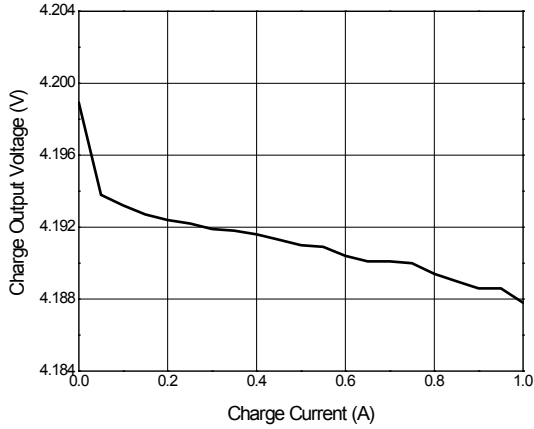

Charge Output Voltage vs. Input Voltage

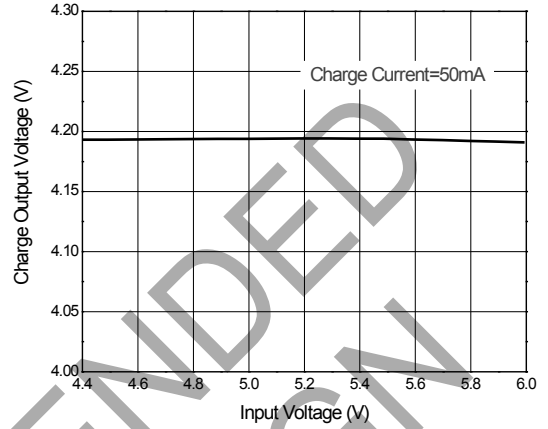

Charge Current vs. Charge Output Voltage

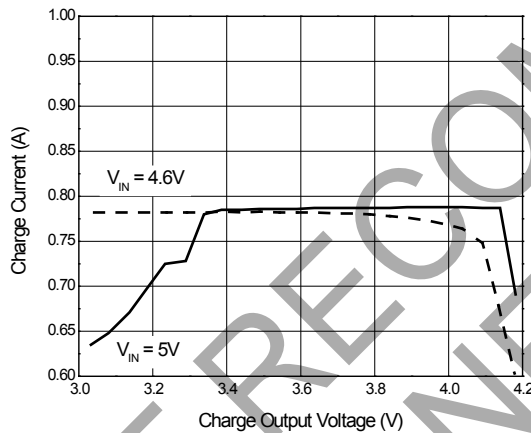

Charge Current vs. Input Voltage

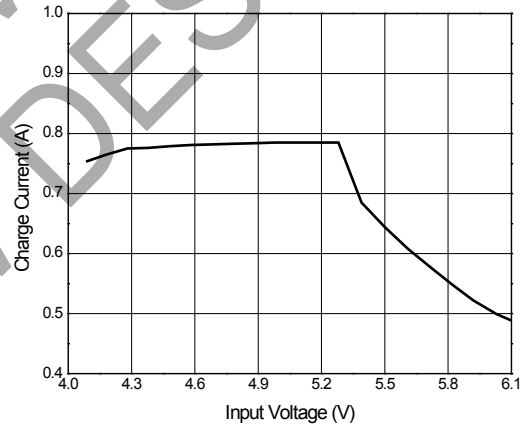

V2P8 Output Voltage vs. Input Voltage

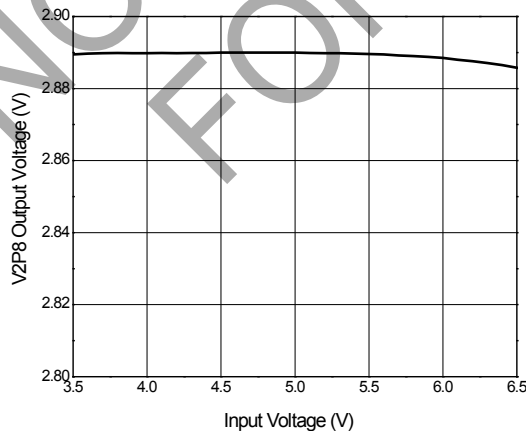

V2P8 Output Voltage vs. V2P8 Load Current

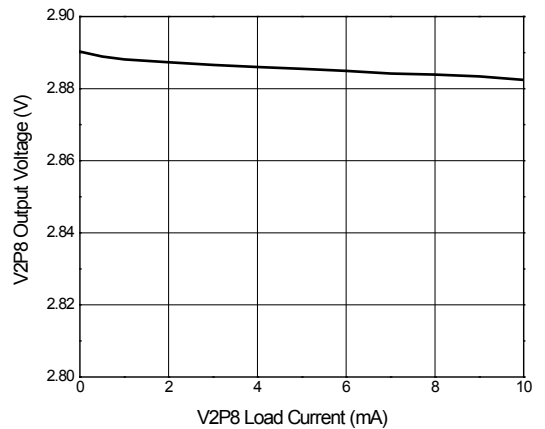

Description of Charge Operation

The AUR9801D initiates a charger operation when attached with a voltage source device or adaptor. Figure 3 shows a typical charge profile when the chip operates as a conventional linear charger with a constant voltage source. The charging current is set by an external resistor up to 1A. The target charging voltage is 0.6% accurate over the specified range.

The charger IC resets internal operational circuits when internal Power-On-Reset (POR) signal becomes valid. V2P8 presents a voltage reference output source capable of driving 2mA current after POR. Other indication output pins are STATUS and FAULT. The STATUS is active low as an open-drain type to indicate a charging cycle and valid till the End-Off-Charge (EOC). The FAULT output signal becomes low to signal any occurred fault conditions such as a charging time fault, battery temperature fault or when the battery is detached.

When charge with a current-limited adapter, AUR9801D should be programmed with I_{REF} over the upper limit of I_{LIM}. A typical charge profile is displayed in Figure 4 for minimizing power dissipation during CC mode. The worst power dissipation is often at the start of CV mode, although thermal fold-back conditions could still occur in this application case.

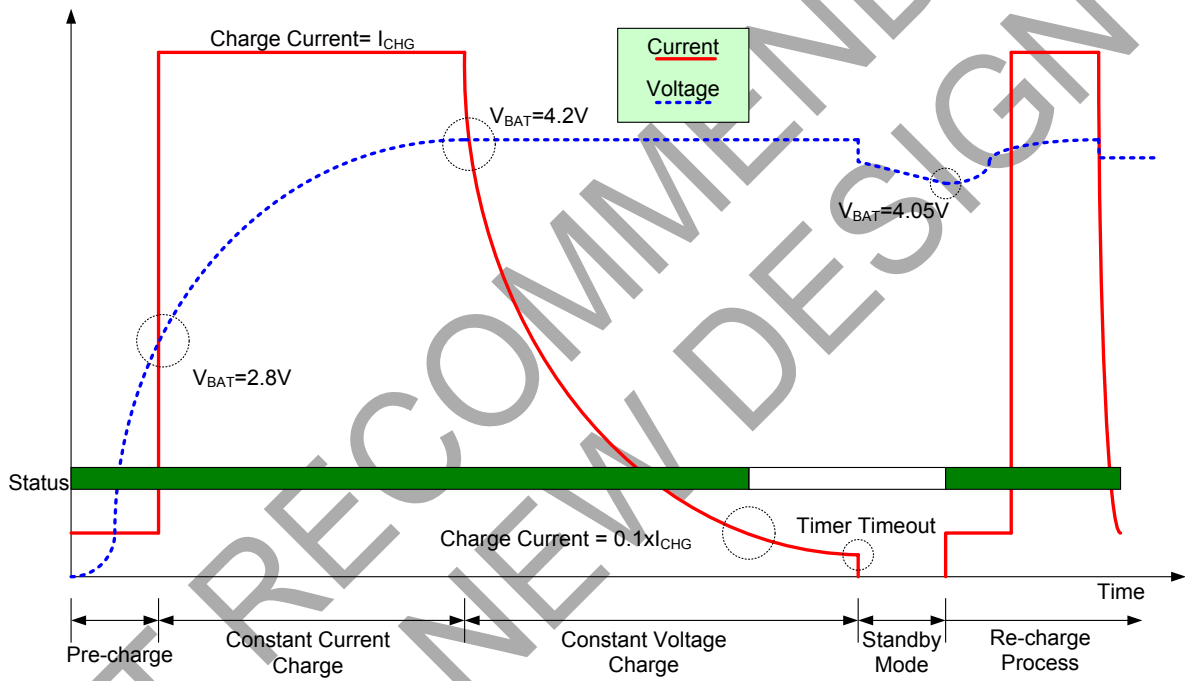

Figure 3. A Typical Charge Profile as a Conventional Linear Charger

Description of Charge Operation (Cont.)

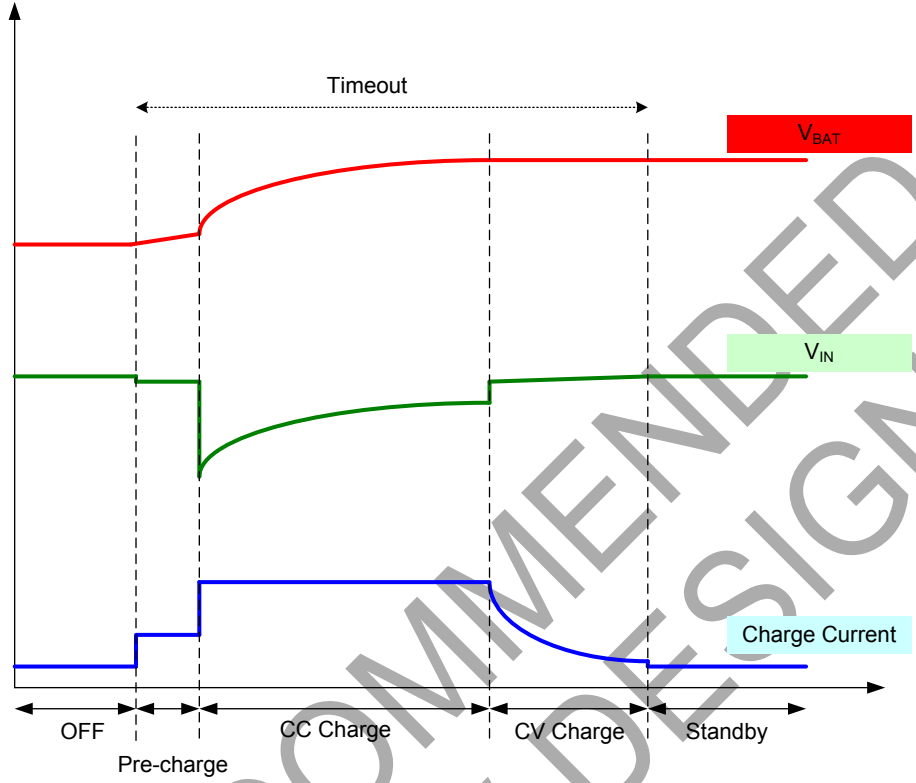

Figure 4. A Typical Charge Profile with a Current-limited Adapter

NOT RECOMMENDED FOR NEW DESIGN

Operation Overview

For linear charging case, the AUR9801D performs either constant current (CC) and constant voltage (CV) profiles. The charging current is set by an external resistor up to 1A for package options. The target charging voltage is 0.6% accurate over the specified range. AUR9801D enters a trickle mode for preconditioning operation each time when a charging cycle starts till that the minimum charging voltage is reached and verified in 15 clock cycles.

A thermal-foldback function offers thermal protection during linear charging operations. When the internal temperature of AUR9801D goes up above +100°C, the charger automatically reduces the charging current. TEMP pin is examined for charging temperature during the charging operation. During $V_{TMIN} < V_{TEMP} < V_{TMAX}$, AUR9801D performs normal charging operation; $V_{TEMP} > V_{TMAX}$, low temperature protection will be detected, AUR9801D will stop charging operation and timer will also be stopped, then fault indication will be issued; $V_{TEMP} < V_{TMIN}$, high temperature protection will be detected, AUR9801D will stop charging operation and timer will also stop, thus fault indication will be issued.

The temperature range is determined with an external NTC thermistor. The NTC need have 4:1 for R_{COLD} to R_{HOT} , once user choose a NTC, the temperature range will be fixed also, then we will have

$$\frac{3.0 \times R_{COLD}}{R_{PU} + R_{COLD}} = 2.0 \quad \dots\dots\dots (1)$$

$$\frac{3.0 \times R_{HOT}}{R_{PU} + R_{HOT}} = 1.0 \quad \dots\dots\dots (2)$$

Using these two formulas, we can get R_{PU} , and also can get R_{COLD} and R_{HOT} refer to the NTC table (resistance-temperature table)

The AUR9801D provides a TIMEOUT limit to prevent charging a dead battery for extensive time. Recharging is automatically started when battery voltage drops to the recharging threshold point.

The AUR9801D enters the shutdown mode in case no voltage adapter is attached.

STATUS	FAULT	Condition
High	High	Power-down, charging is suspended or interrupted
Low	High	Charging
High	Low	Bad battery (Safety timer expired)

Charge current setting

$$I_{CHG} = 0.8 \times \left(\frac{10^5}{R_{IREF}} \right) \quad \text{Where } R_{IREF} \text{ in k}\Omega$$

Charge timer setting

$$\text{Time} = 14 \times \frac{C_{TIME}}{\ln F} \quad \text{Where } \text{Time} \text{ in Minutes}$$

Flow Chart

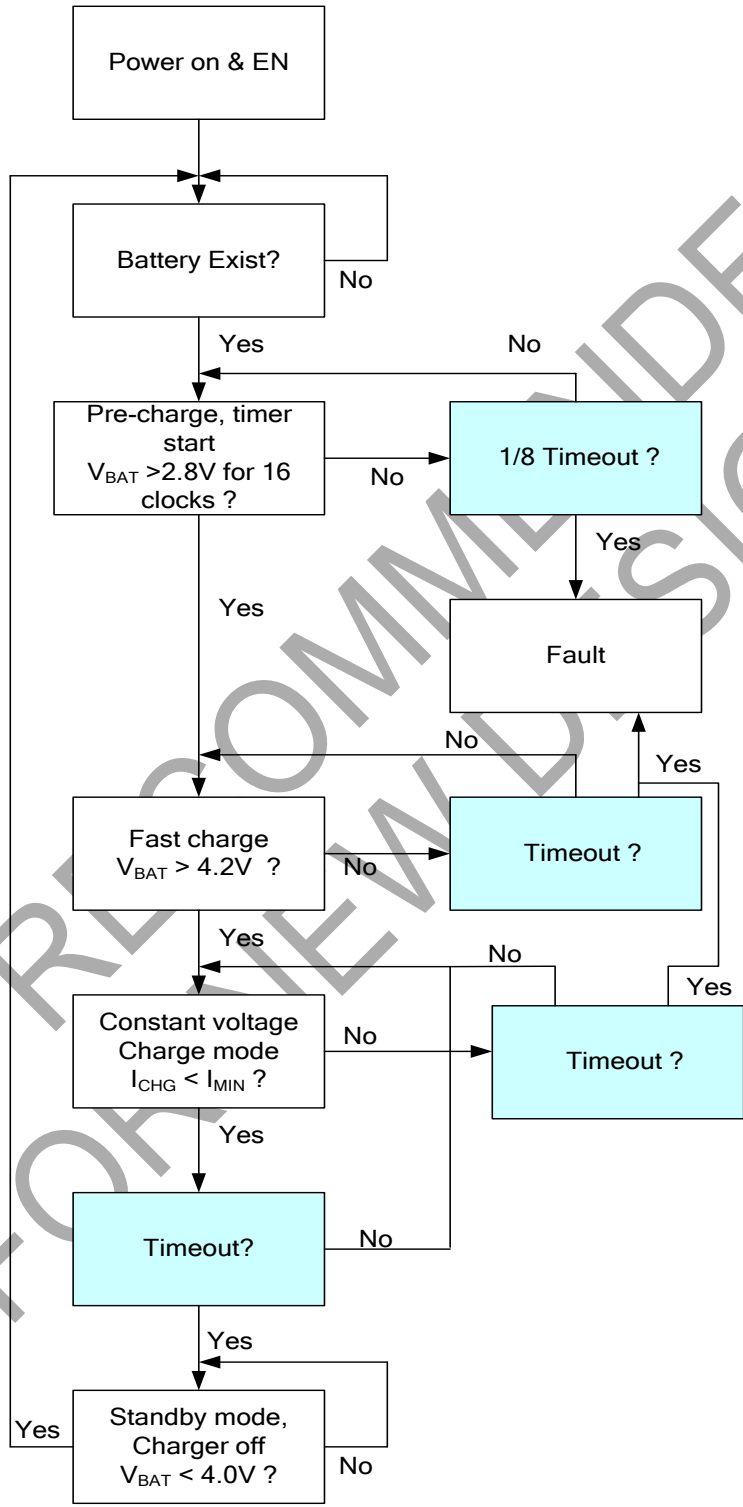

Ordering Information

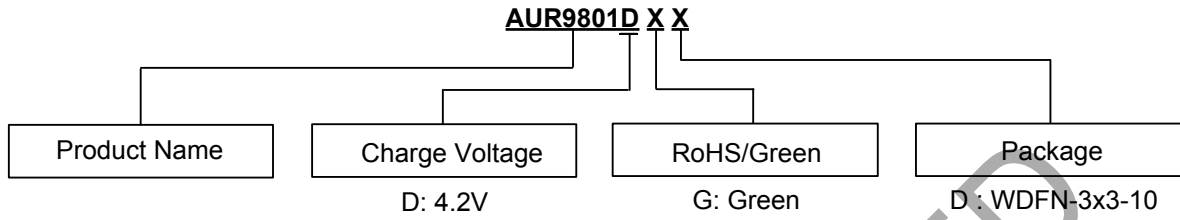

Package	Temperature Range	Part Number	Marking ID	13" Tape and Reel Quantity
WDFN-3x3-10	-40 to +85°C	AUR9801DGD	9801D	5000/Tape & Reel

Marking Information

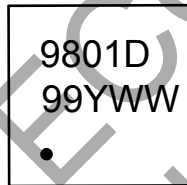

9801D: Identification Code
 99: Lot Number
 Y: Year Code
 WW: Week Code

Part Number	Package	Identification Code
AUR9801DGD	WDFN-3x3-10	9801D

Package Outline Dimensions (All dimensions in mm(inch).)

Please see <http://www.diodes.com/package-outlines.html> for the latest version.

(1) Package Type: WDFN-3×3-10

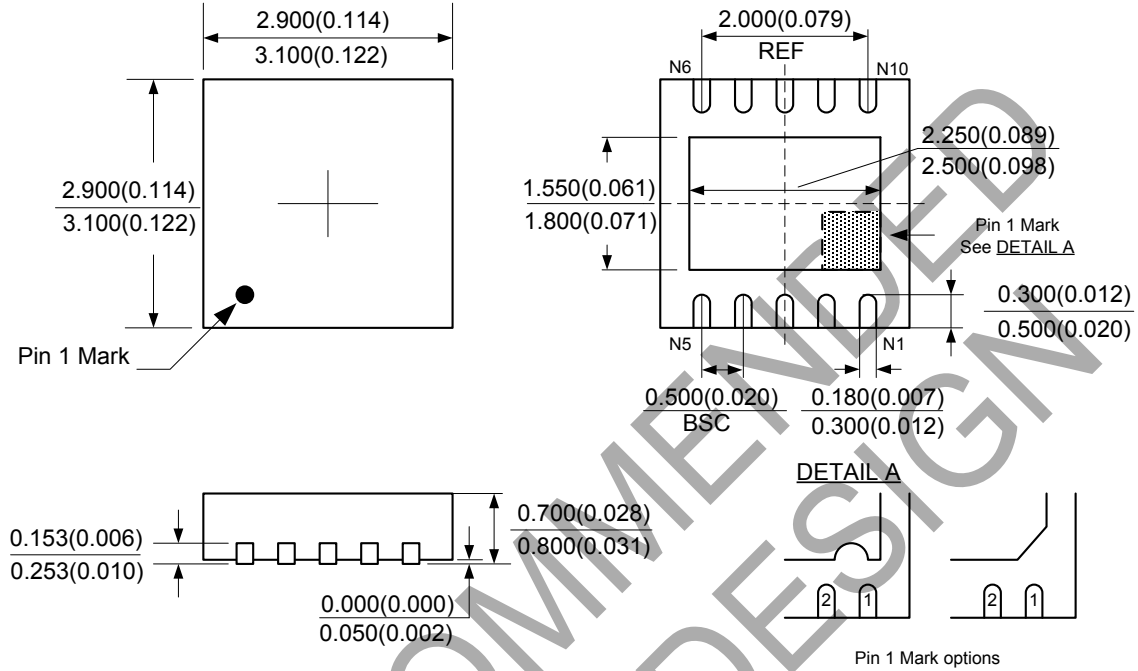

Suggested Pad Layout

Please see <http://www.diodes.com/package-outlines.html> for the latest version.

(1) Package Type: WDFN-3×3-10

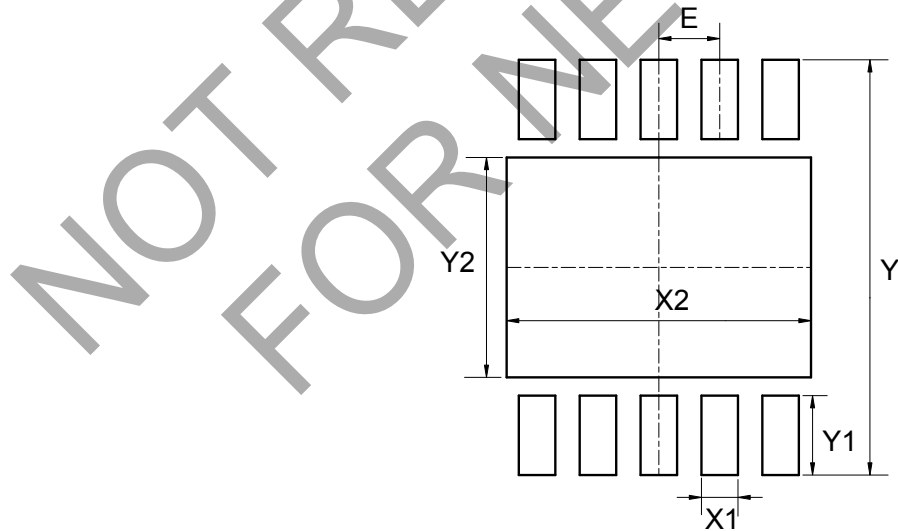

Dimensions	Y (mm)/(inch)	X1 (mm)/(inch)	Y1 (mm)/(inch)	X2 (mm)/(inch)	Y2 (mm)/(inch)	E (mm)/(inch)
Value	3.400/0.134	0.300/0.012	0.650/0.026	2.500/0.098	1.800/0.071	0.500/0.020

IMPORTANT NOTICE

DIODES INCORPORATED MAKES NO WARRANTY OF ANY KIND, EXPRESS OR IMPLIED, WITH REGARDS TO THIS DOCUMENT, INCLUDING, BUT NOT LIMITED TO, THE IMPLIED WARRANTIES OF MERCHANTABILITY AND FITNESS FOR A PARTICULAR PURPOSE (AND THEIR EQUIVALENTS UNDER THE LAWS OF ANY JURISDICTION).

Diodes Incorporated and its subsidiaries reserve the right to make modifications, enhancements, improvements, corrections or other changes without further notice to this document and any product described herein. Diodes Incorporated does not assume any liability arising out of the application or use of this document or any product described herein; neither does Diodes Incorporated convey any license under its patent or trademark rights, nor the rights of others. Any Customer or user of this document or products described herein in such applications shall assume all risks of such use and will agree to hold Diodes Incorporated and all the companies whose products are represented on Diodes Incorporated website, harmless against all damages.

Diodes Incorporated does not warrant or accept any liability whatsoever in respect of any products purchased through unauthorized sales channel. Should Customers purchase or use Diodes Incorporated products for any unintended or unauthorized application, Customers shall indemnify and hold Diodes Incorporated and its representatives harmless against all claims, damages, expenses, and attorney fees arising out of, directly or indirectly, any claim of personal injury or death associated with such unintended or unauthorized application.

Products described herein may be covered by one or more United States, international or foreign patents pending. Product names and markings noted herein may also be covered by one or more United States, international or foreign trademarks.

This document is written in English but may be translated into multiple languages for reference. Only the English version of this document is the final and determinative format released by Diodes Incorporated.

LIFE SUPPORT

Diodes Incorporated products are specifically not authorized for use as critical components in life support devices or systems without the express written approval of the Chief Executive Officer of Diodes Incorporated. As used herein:

A. Life support devices or systems are devices or systems which:

1. are intended to implant into the body, or
2. support or sustain life and whose failure to perform when properly used in accordance with instructions for use provided in the labeling can be reasonably expected to result in significant injury to the user.

B. A critical component is any component in a life support device or system whose failure to perform can be reasonably expected to cause the failure of the life support device or to affect its safety or effectiveness.

Customers represent that they have all necessary expertise in the safety and regulatory ramifications of their life support devices or systems, and acknowledge and agree that they are solely responsible for all legal, regulatory and safety-related requirements concerning their products and any use of Diodes Incorporated products in such safety-critical, life support devices or systems, notwithstanding any devices- or systems-related information or support that may be provided by Diodes Incorporated. Further, Customers must fully indemnify Diodes Incorporated and its representatives against any damages arising out of the use of Diodes Incorporated products in such safety-critical, life support devices or systems.

Copyright © 2019, Diodes Incorporated

www.diodes.com