

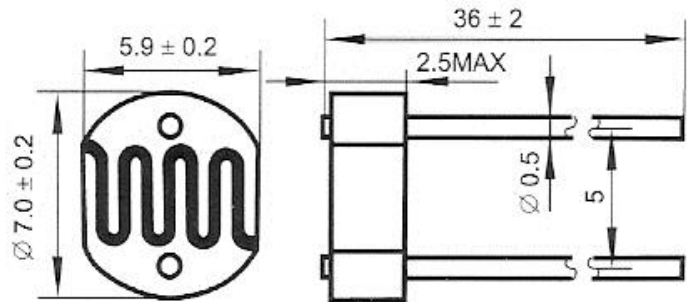

FEATURES

- Miniature open frame package
- Epoxy coated
- Moisture resistant
- Spectral response similar to the human eye
- Applications include dusk-dawn lighting control

LIGHT DEPENDENT RESISTOR



Dimensions in millimetres

SPECIFICATION AND PERFORMANCE

Model	Vmax (VDC)	Pmax (mW)	Ambient temp(°C)	Spectral peak (nm)	Light Resistance at 10Lux (KΩ)	Dark Resistance (MΩ)	Gamma value at 100-10Lux	Response Time (ms)	
								Rise Time	Decay time
GL7537	150	100	-30~+70	540	16-50	3	0.7	20	30

Measuring Conditions

1. Light resistance:

Measured at 10 Lux with standard light A (2854K color temperature) and 2hr illumination at 400-600 lux prior to testing.

2. Dark Resistance:

Measured 10 seconds after closed 10 lux.

3. Gamma Characteristic:

Between 10 lux and 100 lux and given by $\gamma = \lg(R_{10}/R_{100})$
 R10、R100 Cell resistance at 10 lux and 100 lux.

The error of γ is ± 0.1 .

4. Pmax:

Max. power dissipation at ambient temperature of 25 °C.

5. Vmax:

Max. voltage in darkness that may be applied to the cell continuously.

Spectral Response

