

Features

- Maximum 3A Low-Dropout Voltage Regulator
- Ultra Low Dropout Voltage
Typically 220mV at 3A Output Current
- High Output Accuracy over Line, Load and Temperature
- Build-In Soft-Start
- Excellent startup under load from 0 to 3A
- Power-On-Reset Monitoring on Both V_{DD} and V_{IN} Pins
- Power-OK Output function
- Foldback over Current Protection and Thermal shutdown
- 0.1 μ A (typ) Shutdown Supply Current
- Low ESR Output Capacitor(Multi-layer Chip Capacitors (MLCC)) Applicable
- Vout Pull Low Resistance when Disable
- PSOP-8
- Green Product (RoHS, Lead-Free, Halogen-Free Compliant)

Applications

- Notebook PC Applications
- Motherboard Applications
- Low Voltage Logic Supplies
- Microprocessor and Chipset Supplies
- Graphic Cards
- Cordless phones

General Description

The GS7103-A can deliver up to 3A of continuous output current with a typical dropout voltage of only 260mV using internal n-channel MOSFETs. The linear regulator uses a separate VDD supply to power the control circuitry and drive the Internal n-channel MOSFETs. The output voltage is adjustable from 0.8V to the voltage that is very close to V_{IN} .

The GS7103-A allows the use of low-ESR ceramic capacitor as low as 10 μ F. Moreover the IC provide good performance on both line transient response and load transient response.

The GS7103-A provides foldback over current limit and thermal shutdown to prevent the linear regulator from damage. Built-in soft-start minimizes stress on the input power source by reducing capacitive inrush current on start-up. During start-up, POK remain low until the output reaches 92% of its rating value.

The GS7103-A is available in PSOP-8 package package.

Typical Application

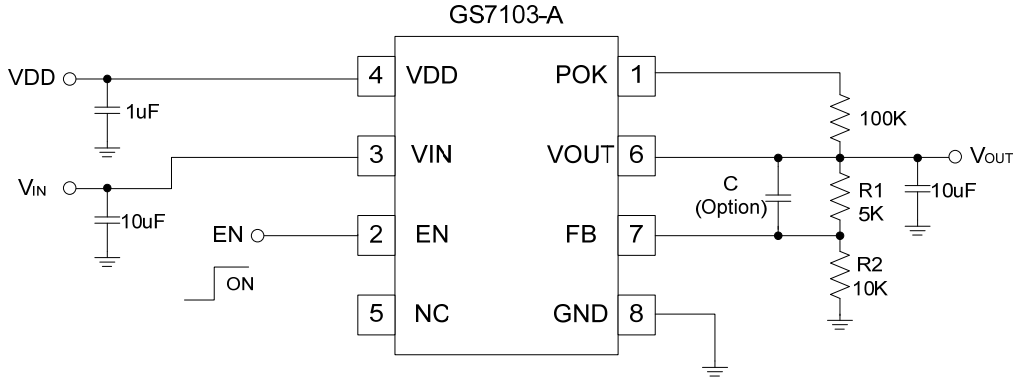

Figure 1 Typical Application of GS7103-A

Function Block Diagram

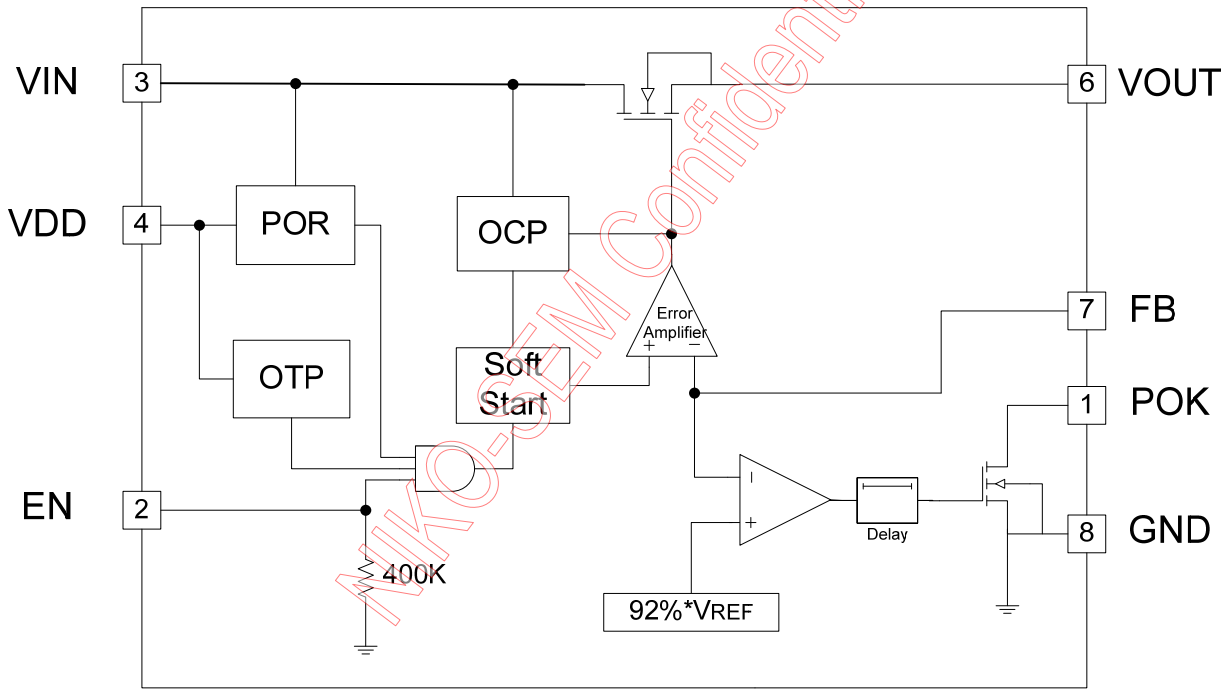
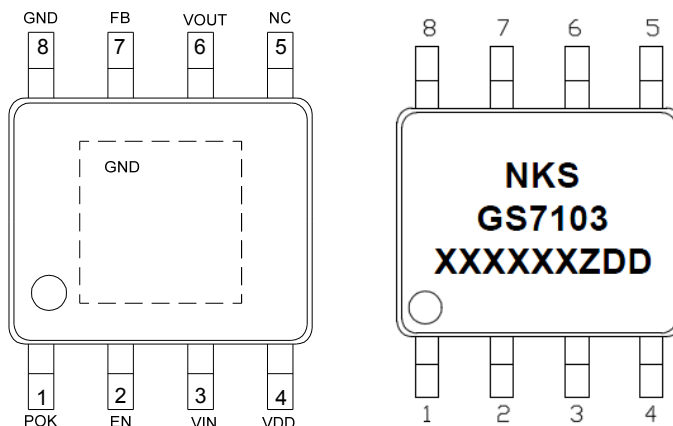

Figure 2 Function Block Diagram

Pin Configuration



PSOP-8 package
(Top view)

Pin Descriptions

Pin No.	Name	I/O type	Pin Function
PSOP-8			
1	POK	O	Open drain output. Setting high impedance once V_{OUT} reaches 92% of its rating voltage
2	EN	I	Chip Enable (active high). The device will be shutdown if this pin is left open.
3	VIN	I	Input Voltage. Large bulk capacitance should be placed closely to this pin. A 10 μ F ceramic capacitor is recommended at this pin.
4	VDD	I	Supply voltage for control circuit
5	NC		Not connected
6	VOUT	O	Output Voltage. The power output of the device.
7	FB	I	Feedback Voltage. This pin is connected to the center tap of an external resistor divider network to set the output voltage as $V_{OUT} = 0.8(R1+R2)/R2$.
8	GND	I	Ground.

Ordering Information

GS7103-A

1. Product name ← → 2. For AMD

No	Item	Contents
1	Product name	GS7103
2	For AMD	-A

Absolute Maximum Rating (Note 1)

Parameter	Symbol	Limits	Units
Supply Voltage	V_{IN}	$-0.3 < V_{IN} < 6$	V
Control Voltage	V_{DD}	$-0.3 < V_{DD} < 6$	V
Output Voltage	V_{OUT}	$-0.3 < V_{OUT} < 5$	V
Package Power Dissipation at $T_A \leq 25^\circ\text{C}$	P_{D_PSOP-8}	1333	mW
Junction Temperature	T_J	- 45 ~ 150	$^\circ\text{C}$
Storage Temperature	T_{STG}	- 65 ~ 150	$^\circ\text{C}$
Lead Temperature (Soldering) 10S	T_{LEAD}	260	$^\circ\text{C}$
ESD (Human Body Mode) (Note 2)	V_{ESD_HBM}	2K	V
ESD (Machine Mode) (Note 2)	V_{ESD_MM}	200	V

Thermal Information (Note 3)

Parameter	Symbol	Limits	Units
Thermal Resistance Junction to Ambient	θ_{JA_PSOP-8}	75	$^\circ\text{C/W}$
Thermal Resistance Junction to Case	θ_{JC_PSOP-8}	12	$^\circ\text{C/W}$

Recommend Operating Condition (Note 4)

Parameter	Symbol	Limits	Units
Supply Voltage	V_{IN}	$1.0 < V_{IN} < \text{Min}\{5.2, V_{DD}\}$	V
Control Voltage	V_{DD}	$3.0 < V_{DD} < 5.5$	V
Junction Temperature	T_J	- 40 ~ 125	°C
Ambient Temperature	T_A	- 40 ~ 85	°C

Electrical Characteristics

($V_{IN} = V_{OUT} + 0.5V$, $V_{EN} = V_{DD} = 5V$, $C_{IN} = C_{OUT} = 10\mu F$, $T_A = T_J = 25^\circ C$)

Parameter	Symbol	Conditions	Min.	Typ.	Max.	Units
Supply Voltage Section						
V_{DD} Operation Voltage Range	V_{DD}	V_{DD} Input Range, $V_{OUT} = V_{REF}$	3.0		5.5	V
V_{IN} Operation Voltage Range	V_{IN}	V_{IN} Input Range, $V_{OUT} = V_{REF}$	1.0		$\text{Min}\{5.2, V_{DD}\}$	V
Quiescent current	I_Q	$V_{DD} = V_{IN} = V_{EN} = 5V$, $I_{OUT} = 0A$, $V_{OUT} = V_{REF}$		1.0	1.5	mA
VDD Input current	I_{VDD}	$V_{DD} = V_{IN} = V_{EN} = 5V$, $I_{OUT} = 0A$, $V_{OUT} = V_{REF}$		1.0	1.5	mA
Control Input Current in Shutdown	I_{VDD_SD}	$V_{DD} = V_{IN} = 5.0V$, $I_{OUT} = 0A$, $V_{EN} = 0V$		0.1	2	uA
V_{DD} POR Threshold	V_{DDRTH}		2.4	2.7	3	V
V_{DD} POR Hysteresis			0.15	0.2		V
V_{IN} POR Threshold	V_{INRTH}		0.55	0.75	0.95	V
V_{IN} POR Hysteresis			0.13	0.20		V
Output Voltage						
Reference Voltage	V_{REF}	$I_{OUT} = 1mA$, $V_{OUT} = V_{REF}$	0.784	0.8	0.816	V
Output Voltage Accuracy			-2.0		+2.0	%
Line Regulation (V_{DD})	ΔV_{LINE_VDD}	$V_{DD} = 4V$ to $5V$, $I_{OUT} = 1mA$, $V_{OUT} = V_{REF}$, $V_{IN} = 2V$		0.03	0.2	%
Line Regulation (V_{IN})	ΔV_{LINE_IN}	$V_{IN} = 1.2V$ to $5V$, $I_{OUT} = 1mA$, $V_{OUT} = V_{REF}$		0.01	0.1	%
Load Regulation (Note 5)	ΔV_{LOAD}	$I_{OUT} = 1mA$ to $3A$, $V_{OUT} = V_{REF}$		0.1	1.5	%
V_{OUT} Pull Low Resistance		$V_{DD} = V_{IN} = 5.0V$, $V_{EN} = 0V$		130		Ω

Dropout Voltage						
Dropout Voltage (Note 6)	V_{DROPO}	$V_{OUT}=V_{REF}, I_{OUT}=2A$		160	200	mV
		$V_{OUT}=V_{REF}, I_{OUT}=3A$		220	290	mV
Protection						
Current Limit	I_{LIM}	$V_{DD}=V_{IN}=V_{EN}=5V, V_{OUT}=V_{REF}$		4		A
Short Circuit Current	$I_{FOLDBACK}$	$V_{OUT}<0.2V$		100		mA
Thermal Shutdown Temperature	T_{SD}	T_J Rising		150		°C
Thermal Shutdown Returned Temperature				100		°C
Enable						
EN Threshold	Logic-Low Voltage	$V_{DD}=5V$			0.7	V
	Logic-High Voltage	$V_{DD}=5V$	1.4			V
EN Input Bias Current	I_{EN}	$V_{EN}=5V$		12	20	uA
Power OK						
POK Rising Threshold		V_{REF} Rising		92		%
POK Hysteresis		V_{REF} falling		8		%
POK Sink Capability		$I_{PGOOD}=1mA$		0.2	0.4	V
POK Delay		-40°C ~125°C		1.3		mS

Note 1. Stresses listed as the above “Absolute Maximum Ratings” may cause permanent damage to the device. These are for stress ratings. Functional operation of the device at these or any other conditions beyond those indicated in the operational sections of the specifications is not implied. Exposure to absolute maximum rating conditions for extended periods may remain possibility to affect device reliability.

Note 2. Devices are ESD sensitive. Handling precaution recommended.

Note 3. θ_{JA} is measured in the natural convection at $T_A=25^\circ C$ on a high effective thermal conductivity test board (4 Layers, 2S2P) of JEDEC 51-7 thermal measurement standard. The case point of θ_{JC} is on the expose pad for PSOP-8 package.

Note 4. The device is not guaranteed to function outside its operating conditions.

Note 5. Regulation is measured at constant junction temperature by using a 2ms current pulse. Devices are tested for load regulation in the load range from 1mA to 3A.

Note 6. The Dropout voltage is defined as $V_{IN}-V_{OUT}$, which is measured when V_{OUT} is $0.98*V_{OUT(NORMAL)}$. The Dropout voltage is measured at constant junction temperature by using a 2ms current pulse.

Typical Characteristics

V_{IN} Line Transient Response

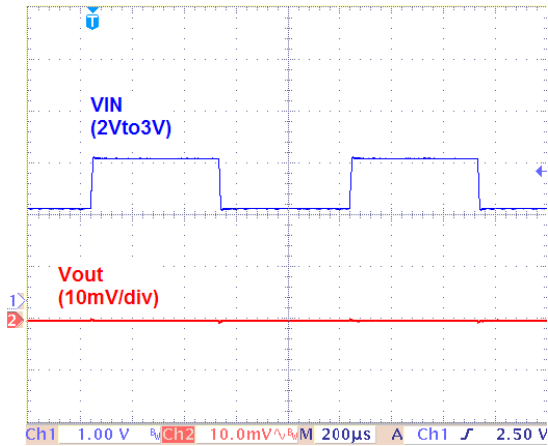

V_{OUT}=1.2V, I_{OUT}=0

V_{IN} Line Transient Response

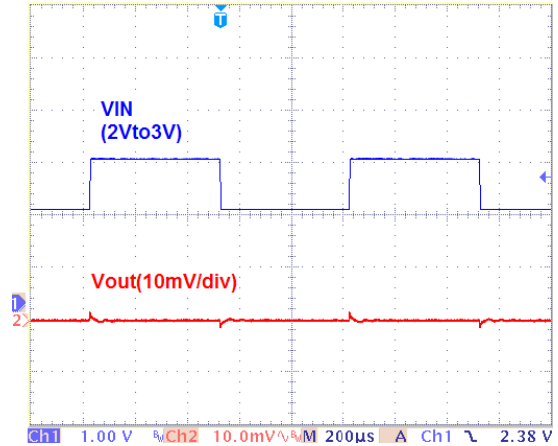

V_{OUT}=1.2V, I_{OUT}=1A

V_{DD} Line Transient Response

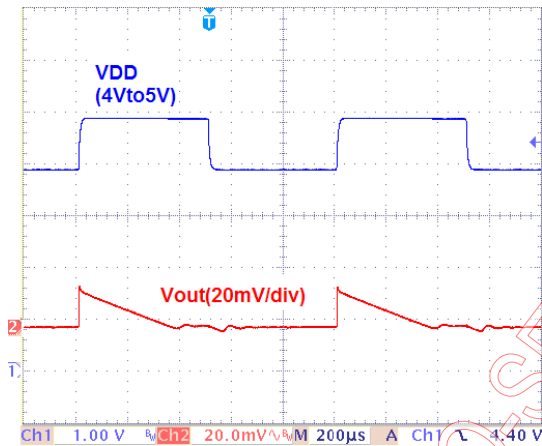

V_{OUT}=1.2V, I_{OUT}=0

V_{DD} Line Transient Response

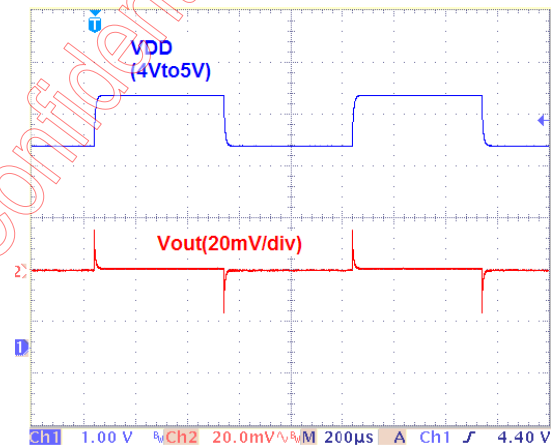

V_{OUT}=1.2V, I_{OUT}=1A

Load Transient Response

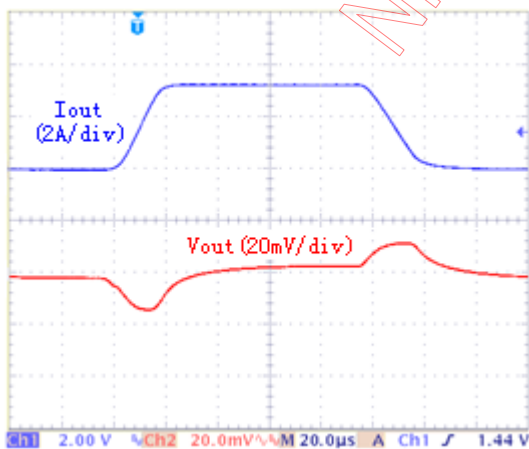

V_{OUT}=1.2V, C_{OUT}=22µF

Power On from VIN

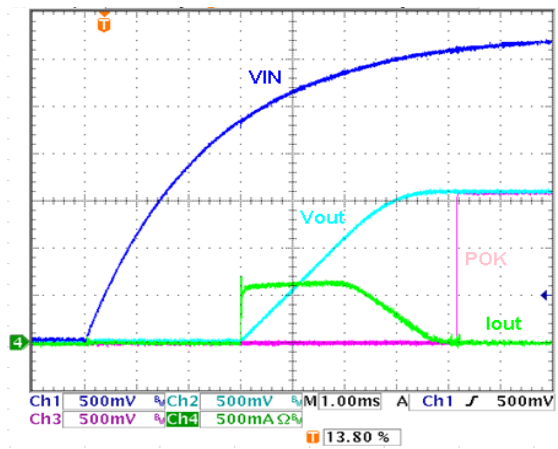

V_{DD}=5V, V_{OUT}=1.6V, C_{OUT}=(1000+10)µF, no load

Power On from V_{DD}

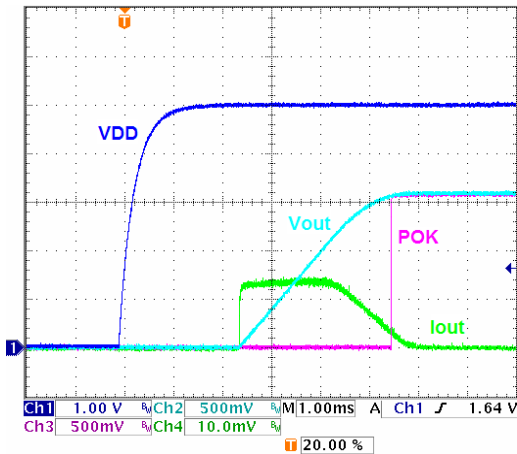

V_{DD}=5V, V_{OUT}=1.6V, C_{OUT}=(1000+10)uF, no load

Turn On from EN

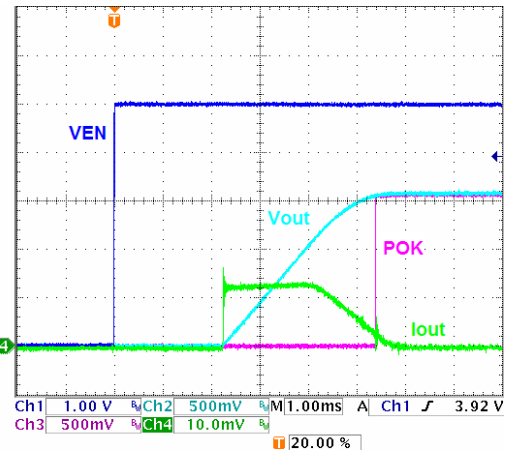

V_{EN}=5V, V_{OUT}=1.6V, C_{OUT}=(1000+10)uF, no load

Turn On from EN

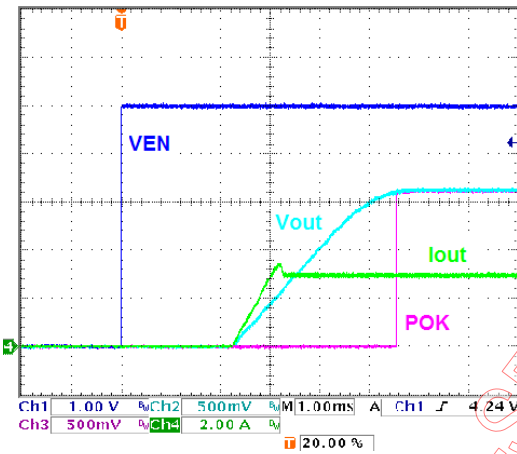

V_{EN}=5V, V_{OUT}=1.6V, C_{OUT}=10uF, I_{load}=3A

Turn On from EN

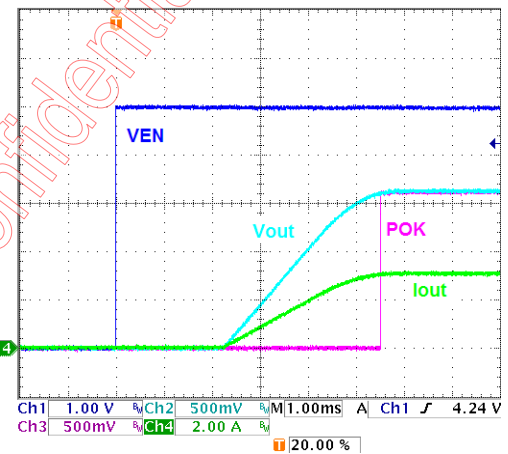

V_{EN}=5V, V_{OUT}=1.6V, C_{OUT}=10uF, R_{load}=0.5

Output Short Current

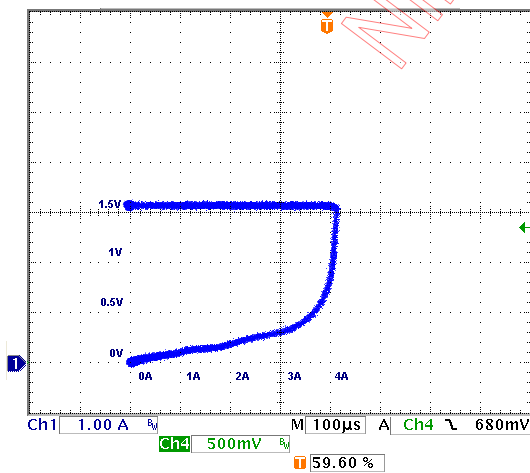

Output Short Current

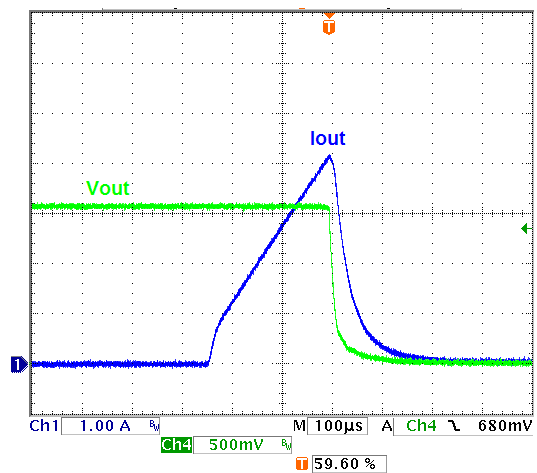

Dropout Voltage vs. Output Current

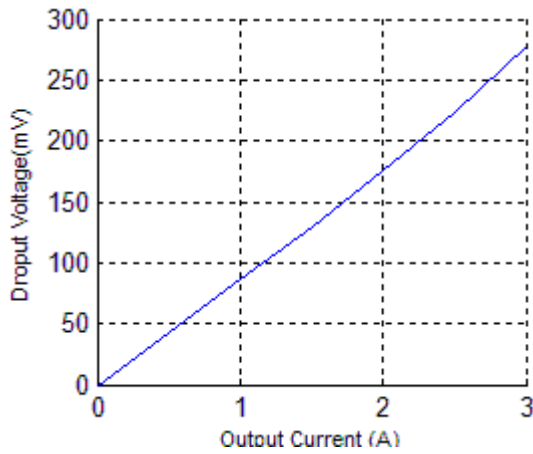

Shutdown Current vs. Input Voltage

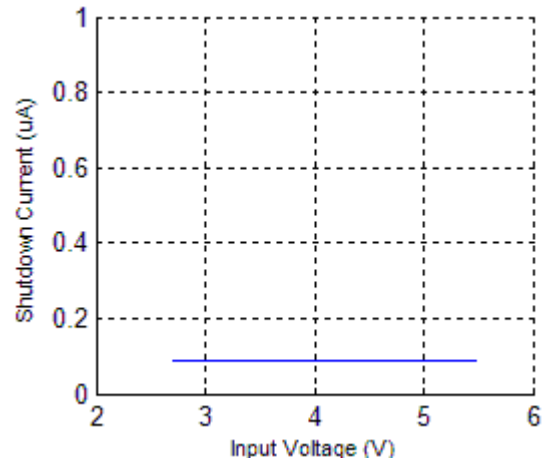

Quiescent Current vs. Input Voltage

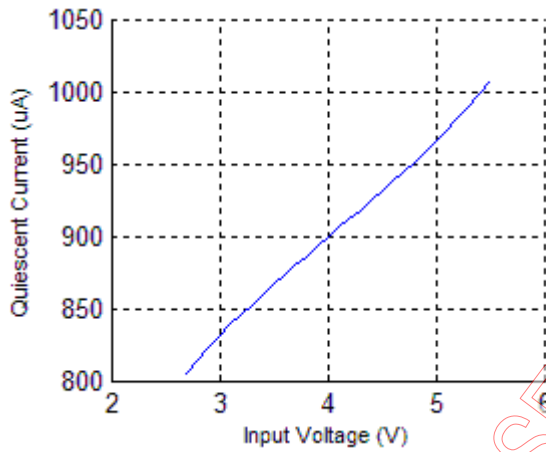

On Resistance vs. Temperature

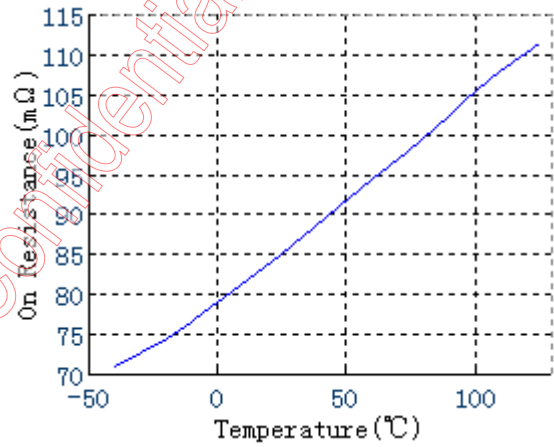

Quiescent Current vs. Temperature

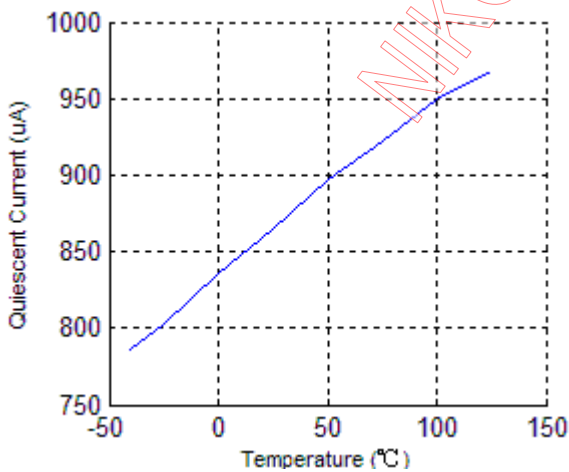

FB Voltage vs. Temperature

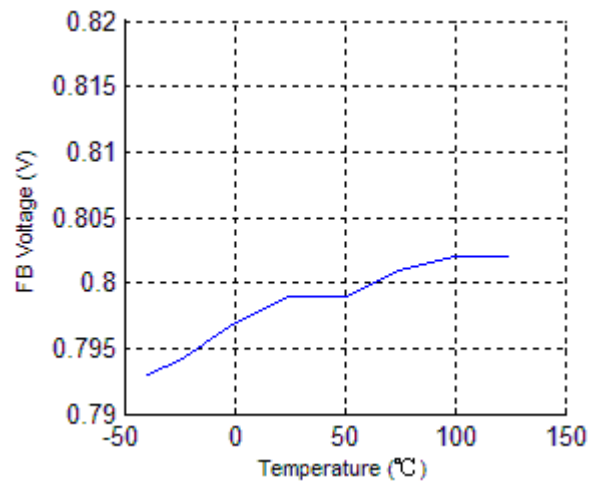

Application Information

Enable

The GS7103-A has a dedicated enable pin(EN). When the EN pin is in the logic low ($V_{EN}<0.6V$), the regulator will be turned off, reducing the supply current to less than 1uA.

When the EN pin is in the logic high ($V_{EN}>1.4V$), the regulator will be turned on and undergoes a new soft-start cycle. Left open, the EN pin is pulled down by a internal resistor to shut down the regulator.

Power-on-Reset

The GS7103-A features a power-on-reset control through monitor both input voltages to prevent wrong operations. Only after the two supply voltages exceed their rising POR threshold voltages, the regulator is to be initiated and starts up.

POK

The POK pin is an open-drain output, and can be connects to V_{OUT} or other rail through an external pull-up resistor. As the output voltage arrives 92% of normal output voltage, an internal delay function starts to perform a delay time and then output the POK pin high to indicate the output is OK. As the output voltage falls below the falling Power-OK threshold or one of the two supply voltages falls below it's falling POR threshold, the POK pin will output low immediately without a delay time.

Build-In Soft-Start

An internal soft-start function controls rise rate of the output voltage to limit the current surge at start-up. The typical soft-start interval is about 3mS.

Current Limit

The GS7103-A contains a foldback over current protection function. It allows the output current to

reach the maximum value of 4A. Then further decreases in the load resistance reduce both the load current and the load voltage. The main advantage of foldback limiting is less power dissipation in the pass transistor under shorted-load conditions. During startup, the current limit value is set to a high value, thus GS7103-A can operate in full load condition. After startup, the current limit value is set to a normal value, so the pass transistor can be protected well.

Thermal-Shutdown Protection

Thermal Shutdown protects GS7103-A from excessive power dissipation. If the die temperature exceeds 150°C, the pass transistor is shut off. 50°C of hysteresis prevents the regulator from turning on until the die temperature drops to 100°C.

Output Capacitor selection

The GS7103-A is designed to employ ceramic output capacitors as low as 10uF; if employ EL output capacitor as large as 1000uF, feedback resistance(R_{bottom}) should be larger than 100K ohm(Table 2). Place the capacitors physically as close as possible to the device with wide and direct PCB traces. Capacitor ESR should be less than 50mohm.

	Cout	Rbottom
Ceramic	$\geq 10\mu F$	$\geq 0.1K\Omega$
EL	1000uF	$\geq 100K\Omega$

Table 1 Cout capacitor vs. Rbottom resistance

Feedback Network

Figure 3 shows the feedback network. The suggested design procedure is to choose $R_2=10K\Omega$ and then calculate R_1 using the following formula: $R_1=(V_{OUT} / V_{REF} -1)*R_2$.

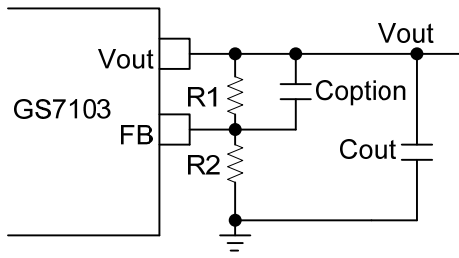

Figure 3 Feedback Network

C_{OPTION} can improve transient response, and recommend value as follow:

V _{OUT}	R1	C _{OPTION}
0.8V ~ 1.6V	0 ~ 10 KΩ	470pF~1nF
1.6V ~ 2.4V	10 KΩ ~ 20 KΩ	100pF~500pF
2.4V ~ 3.6V	20 KΩ ~ 30 KΩ	20pF~300pF

Table 2 R1 vs. C_{OPTION}

Input Capacitor selection

Bypass VIN to ground with a 10uF or greater capacitor. Bypass VDD to ground with a 1uF capacitor for normal operation in most applications. Ceramic, tantalum or aluminum electrolytic capacitors may be selected for input capacitor. However ceramic capacitors are recommended due to their significant cost and space savings. Place the capacitors physically as close as possible to the device with wide and direct PCB traces.

Power Dissipation and Layout Considerations

Although internal thermal limiting function is integrated in GS7103-A, continuously keeping the junction near the thermal shutdown temperature may possibly affect device reliability. For continuous operation, it is highly recommended to keep the junction temperature below the maximum operation junction temperature 125°C for maximum reliability.

The power dissipation definition in device is:

$$P_D = (V_{IN} - V_{OUT}) \times I_{OUT} + V_{DD} \times I_Q$$

The maximum power dissipation can be calculated as:

$$P_{D(MAX)} = (T_{J(MAX)} - T_A) / \theta_{JA}$$

Where T_{J(MAX)} is the maximum operation junction temperature 125°C, T_A is the ambient temperature and the θ_{JA} is the junction to ambient thermal resistance.

The thermal resistance θ_{JA} for PSOP-8 package is 75°C/W on the standard JEDEC 51-7 (4 layers, 2S2P) thermal test board. The copper thickness is 2oz. The maximum power dissipation at T_A = 25°C can be calculated by following formula:

$$P_{D(MAX)} = (125°C - 25°C) / (75°C/W) = 1.33W$$

(SOP-8 Exposed Pad on the minimum layout)

The thermal resistance θ_{JA} of PSOP-8 is determined by the package design and the PCB design. Copper plane under the exposed pad is an effective heat sink and is useful for improving thermal conductivity. As shown in Figure 3, the amount of copper area to which the PSOP-8 is mounted affects thermal performance. When mounted to the standard PSOP-8 pad (Figure 4.a), θ_{JA} is 75°C/W. Adding copper area of pad under the PSOP-8 Figure 4.b) reduces the θ_{JA} to 54°C/W. Even further, increasing the copper area of pad to 70mm² (Figure 4.c) reduces the θ_{JA} to 49°C/W.

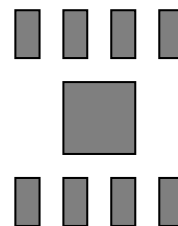

Figure 4 (a) Minimum Footprint, θ_{JA} = 75°C/W

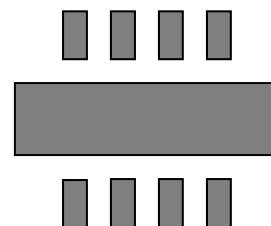

Figure 4 (b) Copper Area = 30mm², θ_{JA} = 54°C/W

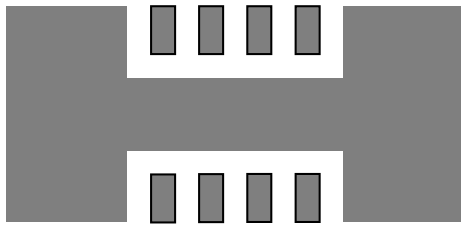

Figure 4 (c) Copper Area = 70mm², θ_{JA} = 49°C/W

Figure 4 θ_{JA} vs. Different Cooper Area Layout Design And Figure 4 shows a curve for the θ_{JA} of the PSOP-8 package for different copper area sizes using a typical PCB with 2oz copper in still air.

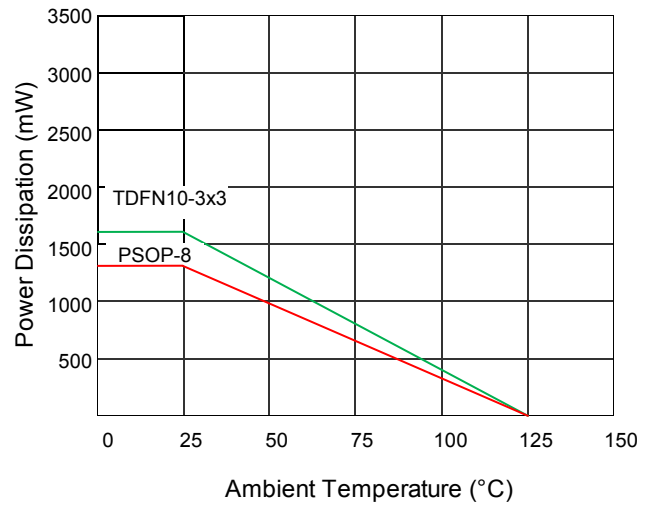

Figure 6 Derating Curve for Packages

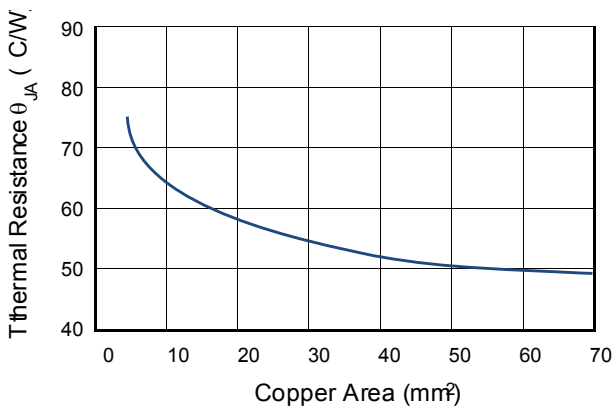
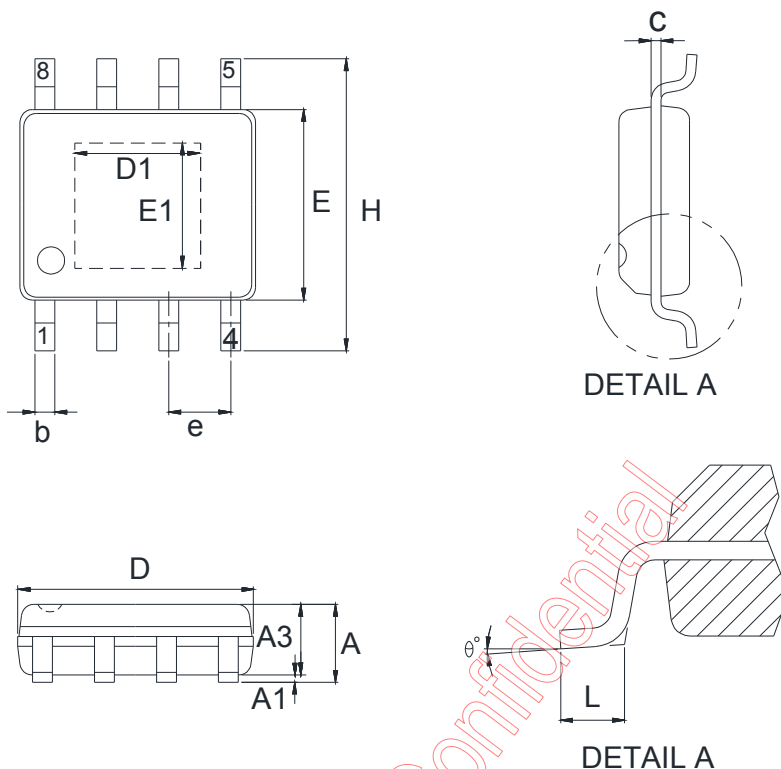

Figure 5 θ_{JA} vs. Copper Area

The maximum power dissipation depends on operating ambient temperature or fixed $T_{J(MAX)}$ and thermal resistance θ_{JA} . For GS7103-A packages, the Figure 5 of derating curves allows the designer to see the effect of rising ambient temperature on the maximum power allowed.

Package Dimensions, PSOP-8(B)



Symbol	Dimensions in Millimeters	
	Min.	Max.
A	1.30	1.80
A1	-	0.15
A3	1.25	-
b	0.31	0.51
c	0.17	0.25
e	1.27 REF.	
D	4.70	5.10
E	3.80	4.00
D1	3.1 REF.	
E1	2.3 REF.	
H	5.80	6.20
L	0.40	1.27
θ	0°	8°

Note:

1. Min.: Minimum dimension specified.
2. Max.: Maximum dimension specified.
3. REF.: Reference. Normal/Regular dimension specified for reference.

DISCLAIMERS

Please read the notice stated in this preamble carefully before Admission e accessing any contents of the document attached. Admission of NIKO-SEM's statement therein is presumed once the document is released to the receiver.

Notice:

Firstly, NIKO SEMICONDUCTOR CO., LTD. (NIKO-SEM) reserves the right to make corrections, modifications, enhancements, improvements, and other changes to its information herein without notice.. And the aforesaid information does not form any part or parts of any quotation or contract between NIKO-SEM and the information receiver.

Further, no responsibility is assumed for the usage of the aforesaid information. NIKO-SEM makes no representation that the interconnect of its circuits as described herein will not infringe on exiting or future patent rights and other intellectual property rights, nor do the descriptions contained herein express or imply that any licenses under any NIKO-SEM patent right, copyright, mask work right, or other NIKO-SEM intellectual property right relating to any combination, machine, or process in which NIKO-SEM products or services are used.

Besides, the product in this document is not designed for use in life support appliances, devices, or systems where malfunction of this product can reasonably be expected to result in personal injury. NIKO-SEM customers' using or selling this product for use in such applications shall do so at their own risk and agree to fully indemnify NIKO-SEM for any damage resulting from such improper use or sale.

At last, the information furnished in this document is the property of NIKO-SEM and shall be treated as highly confidentiality; any kind of distribution, disclosure, copying, transformation or use of whole or parts of this document without duly authorization from NIKO-SEM by prior written consent is strictly prohibited. The receiver shall fully compensate NIKO-SEM without any reservation for any losses thereof due to its violation of NIKO-SEM's confidential request. The receiver is deemed to agree on NIKO-SEM's confidential request therein suppose that said receiver receives this document without making any expressly opposition. In the condition that aforesaid opposition is made, the receiver shall return this document to NIKO-SEM immediately without any delay.