

### Features

- ◆ 150 Watts peak pulse power ( $t_p = 8/20\mu s$ )
- ◆ Transient protection for high speed data lines to IEC 61000-4-2 (ESD)  $\pm 15kV$  (air),  $\pm 8kV$  (contact) IEC 61000-4-4 (EFT) 40A (5/50ns)
- ◆ Protects One Power or I/O Port
- ◆ Low leakage current
- ◆ Low operating and clamping voltages
- ◆ Solid-state silicon avalanche technology

### Mechanical Characteristics

- Package: SOD-523
- Lead Finish: Matte Tin
- Case Material: "Green" Molding Compound.
- UL Flammability Classification Rating 94V-0
- Moisture Sensitivity: Level 3 per J-STD-020
- Terminal Connections: See Diagram Below

### Applications

- Cellular Handsets and Accessories
- Personal Digital Assistants
- Notebooks and Handhelds
- Portable Instrumentation
- Digital Cameras
- Peripherals
- Audio Players
- Keypads, Side Keys, LCD Displays, USB2.0

### Ordering Information

| Part Number   | Qty per Reel | Reel Size |
|---------------|--------------|-----------|
| TPPESD24VS1UB | 3000         | 7"        |

### Dimensions and Pin Configuration

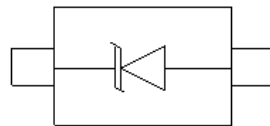

SOD-523 (Top View)

### Absolute Maximum Ratings ( $T_A=25^\circ\text{C}$ unless otherwise specified)

| Parameter                       | Symbol | Value       | Unit             |
|---------------------------------|--------|-------------|------------------|
| ESD per IEC 61000-4-2 (Air)     | VESD   | $\pm 15$    | kV               |
| ESD per IEC 61000-4-2 (Contact) |        | $\pm 8$     |                  |
| Operating Temperature Range     | TJ     | -55 to +125 | $^\circ\text{C}$ |
| Storage Temperature Range       | Tstg   | -55 to +150 | $^\circ\text{C}$ |

### Electrical Characteristics ( $T_A=25^\circ\text{C}$ unless otherwise specified)

| Symbol    | Parameter                                   |
|-----------|---|
| $I_{PP}$  | Maximum Reverse Peak Pulse Current          |
| $V_C$     | Clamping Voltage @ $I_{PP}$                 |
| $V_{RWM}$ | Working Peak Reverse Voltage                |
| $I_R$     | Maximum Reverse Leakage Current @ $V_{RWM}$ |
| $V_{BR}$  | Breakdown Voltage @ $I_T$                   |
| $I_T$     | Test Current                                |
| $I_F$     | Forward Current                             |
| $V_F$     | Forward Voltage @ $I_F$                     |
| $P_{pk}$  | Peak Power Dissipation                      |
| C         | Capacitance @ $V_R = 0$ and $f = 1.0$ MHz   |

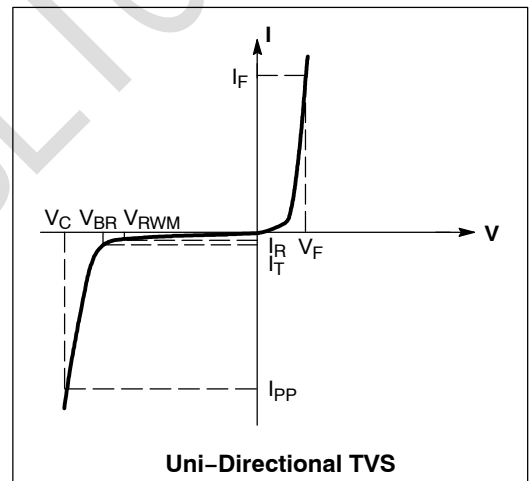

| Parameter               | Symbol    | Min | Typ | Max | Unit          | Test Condition                                    |
|-------------------------|-----------|-----|-----|-----|---------------|---|
| Reverse Working Voltage | $V_{RWM}$ |     |     | 24  | V             |   |
| Breakdown Voltage       | $V_{BR}$  | 26  |     | 32  | V             | $I_T = 1\text{mA}$                                |
| Reverse Leakage Current | $I_R$     |     |     | 1   | $\mu\text{A}$ | $V_{RWM} = 24\text{V}$                            |
| Clamping Voltage        | $V_C$     |     |     | 60  | V             | $I_{PP} = 3\text{A}$ (8 x 20 $\mu\text{s}$ pulse) |
| Junction Capacitance    | $C_J$     |     | 25  |     | pF            | $V_R = 0\text{V}$ , $f = 1\text{MHz}$             |

## Characteristic Curves

**Fig1. 8/20 $\mu$ s Pulse Waveform**

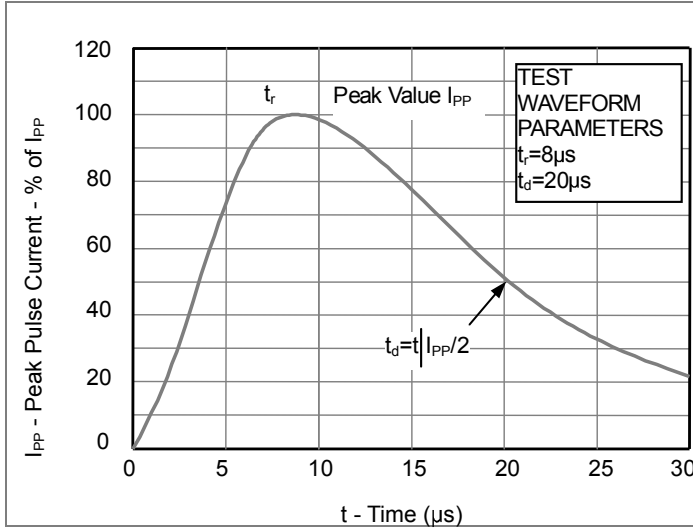

**Fig2. ESD Pulse Waveform (according to IEC 61000-4-2)**

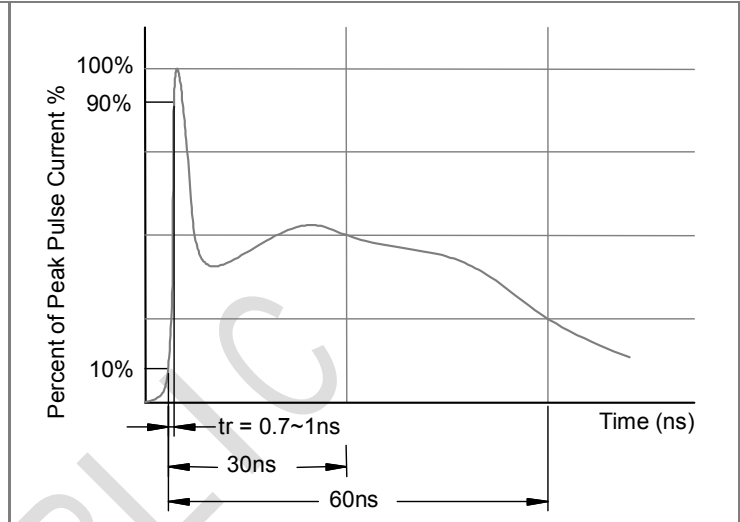

**Fig3. Power Derating Curve**

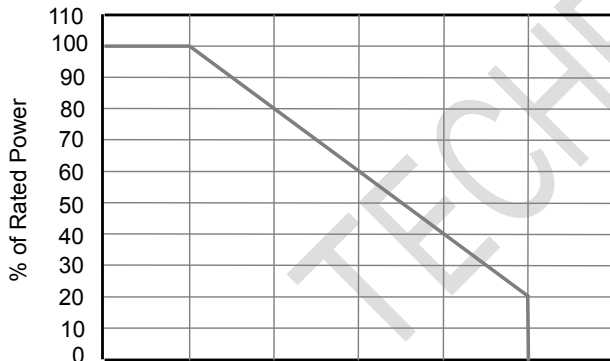

**SOD-523 Package Outline Drawing**

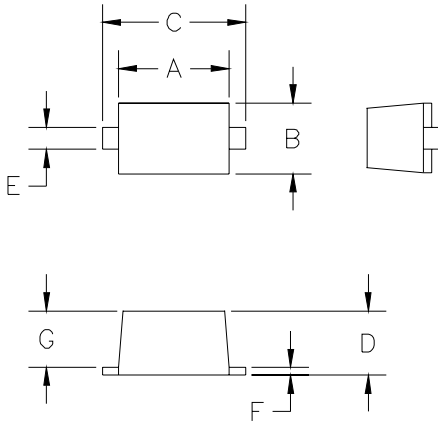

| DIM <sup>N</sup> | INCHES |      | MM [1] |      | NOTE |
|------------------|--------|------|--------|------|------|
|                  | MIN    | MAX  | MIN    | MAX  |      |
| A                | .043   | .051 | 1.10   | 1.30 | —    |
| B                | .028   | .035 | 0.70   | 0.90 | —    |
| C                | .059   | .067 | 1.50   | 1.70 | —    |
| D                | .020   | .028 | 0.50   | 0.70 | —    |
| E                | .010   | .014 | 0.25   | 0.35 | —    |
| F                | .004   | .008 | 0.10   | 0.20 | —    |
| G                | .020   | .028 | 0.50   | 0.70 | —    |

[1] CONTROLLING DIMENSION: MILLIMETERS

**Suggested Land Pattern**

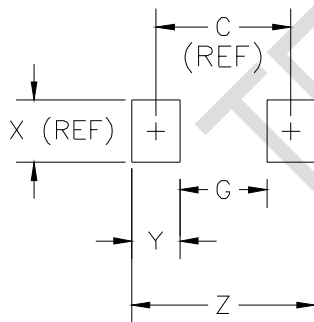

| DIM <sup>N</sup> | INCHES |      | MM [1] |      | NOTE |
|------------------|--------|------|--------|------|------|
|                  | MIN    | MAX  | MIN    | MAX  |      |
| C                | —      | .067 | —      | 1.70 | REF  |
| G                | —      | .043 | —      | 1.10 | —    |
| X                | —      | .031 | —      | 0.80 | REF  |
| Y                | —      | .024 | —      | 0.60 | —    |
| Z                | —      | .091 | —      | 2.30 | —    |

[1] CONTROLLING DIMENSION: MILLIMETERS