

Features

- ◆ Ultra low capacitance: 0.35 pF typical (I/O to I/O)
- ◆ Ultra low leakage: nA level
- ◆ Low operating voltage: 5.5V
- ◆ Low clamping voltage
- ◆ Up to 4 data lines and one power line protects
- ◆ Complies with following standards:
 - IEC 61000-4-2 (ESD) immunity test
 - Air discharge: ±25kV
 - Contact discharge: ±25kV
 - IEC61000-4-4 (EFT) 40A (5/50ns)
- ◆ ROHS Compliant

Ordering Information

Part Number	Qty per Reel	Reel Size
TPCM1213A-04SO	3000	7"

Mechanical Characteristics

- ◆ Package: SOT23-6
- ◆ Lead Finish: Matte Tin
- ◆ Case Material: "Green" Molding Compound.
- ◆ UL Flammability Classification Rating 94V-0
- ◆ Moisture Sensitivity: Level 3 per J-STD-020



Applications

- ◆ USB 2.0 and USB 3.0 Ports
- ◆ USB OTG
- ◆ Digital video interface(DVI)
- ◆ Monitor and Flat Panel Displays
- ◆ PCI Express and Serial SATA Ports
- ◆ Gigabit Ethernet
- ◆ IEEE 1394 firewire ports
- ◆ Consumer products (STB, DVD, DSC, DVC...)

Dimensions and Pin Configuration

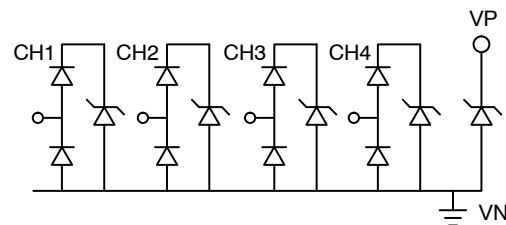
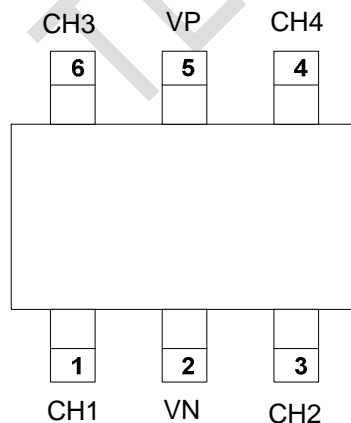

Circuit and Pin Schematic

Absolute Maximum Ratings (Tamb=25°C unless otherwise specified)

Parameter	Symbol	Value	Unit
ESD per IEC 61000-4-2 (Air)	VESD	±25	kV
ESD per IEC 61000-4-2 (Contact)		±25	
Operating Temperature Range	TJ	-55 to +125	°C
Storage Temperature Range	Tstg	-55 to +150	°C

Electrical Characteristics (TA=25°C unless otherwise specified)

Parameter	Symbol	Min	Typ	Max	Unit	Test Condition
Reverse Working Voltage	VRWM		3.3	5.5	V	Any I/O pin to ground
Breakdown Voltage	VBR	6			V	IT = 1mA, any I/O pin to ground
Reverse Leakage Current	IR			0.3	μA	VRWM = 5V, any I/O pin to ground
Clamping Voltage	VC			20	V	I _{PP} = 3A (8 x 20μs pulse) any I/O pin to ground
Junction Capacitance	CJ		0.35	0.4	pF	VR = 0V, f = 1MHz, between I/O pins
Junction Capacitance	CJ			0.8	pF	VR = 0V, f = 1MHz, any I/O pin to ground

Note 1: I/O pins are Pin 1, 3, 4 and 6

Fig1. 8/20μs Pulse Waveform

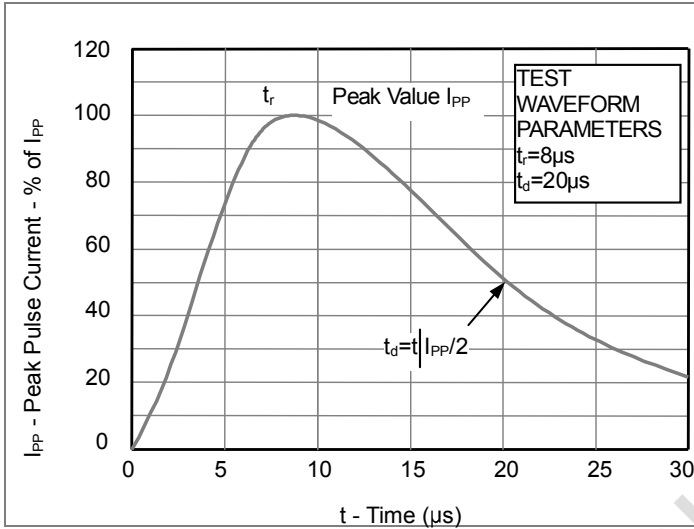

Fig2. ESD Pulse Waveform (according to IEC 61000-4-2)

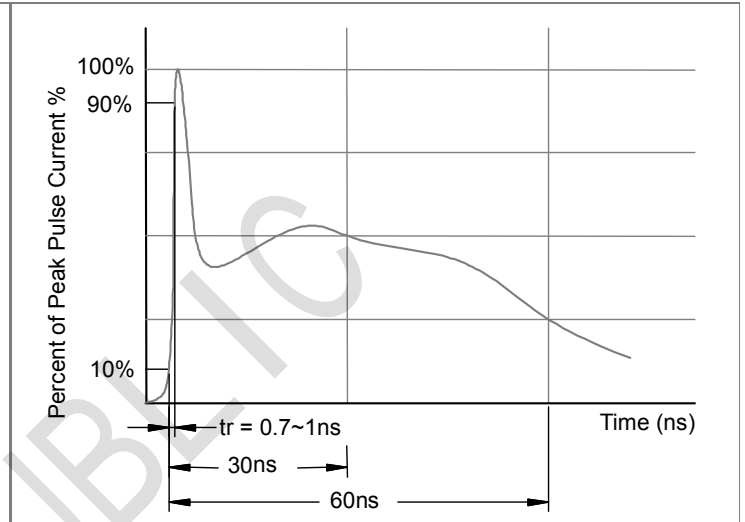
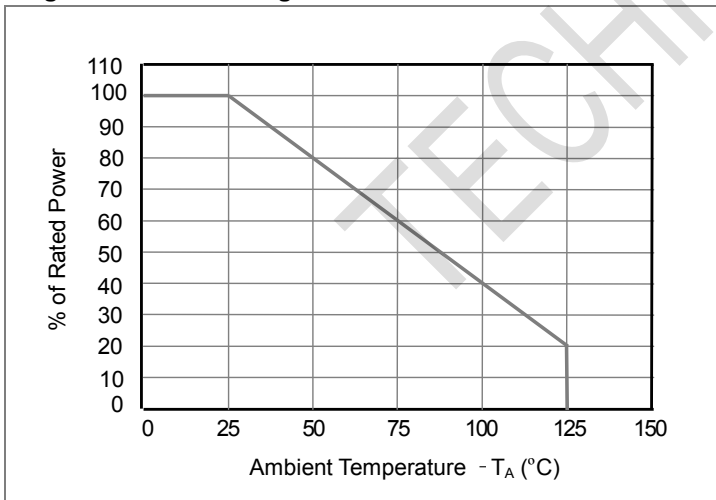
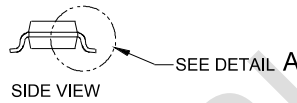
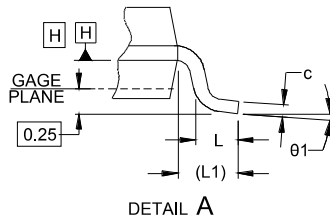
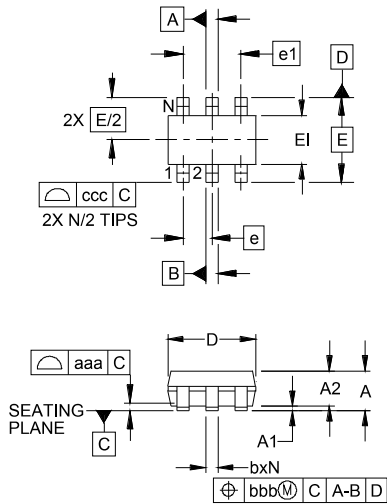

Fig3. Power Derating Curve



Outline Drawing - SOT23-6



DIM	INCHES			MILLIMETERS		
	MIN	NOM	MAX	MIN	NOM	MAX
A	.035	-	.057	0.90	-	1.45
A1	.000	-	.006	0.00	-	0.15
A2	.035	.045	.051	.90	1.15	1.30
b	.010	-	.020	0.25	-	0.50
c	.003	-	.009	0.08	-	0.22
D	.110	.114	.118	2.80	2.90	3.00
E1	.060	.063	.069	1.50	1.60	1.75
E	.110 BSC			2.80 BSC		
e	.037 BSC			0.95 BSC		
e1	.075 BSC			1.90 BSC		
L	.012	.018	.024	0.30	0.45	0.60
L1	(0.024)			(0.60)		
N	6			6		
theta 1	0°	-	10°	0°	-	10°
aaa	.004			0.10		
bbb	.008			0.20		
ccc	.008			0.20		

Land Pattern - SOT23-6

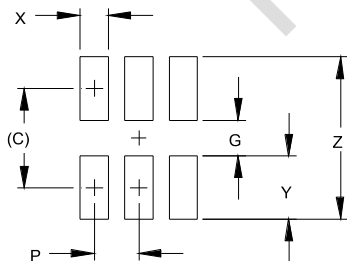

DIMENSIONS		
DIM	INCHES	MILLIMETERS
C	(.098)	(2.50)
G	.055	1.40
P	.037	0.95
X	.024	0.60
Y	.043	1.10
Z	.141	3.60