

RoHS compliant

REV	DATE	MODIFICATION	APPROVER
A1	2018.4.13		JASON

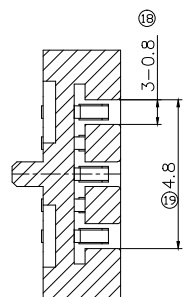

SEC A-A

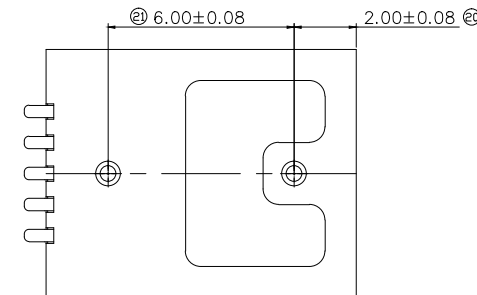
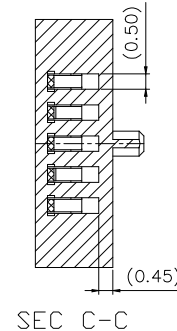
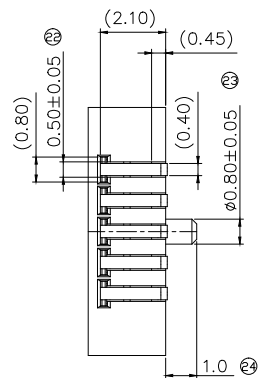
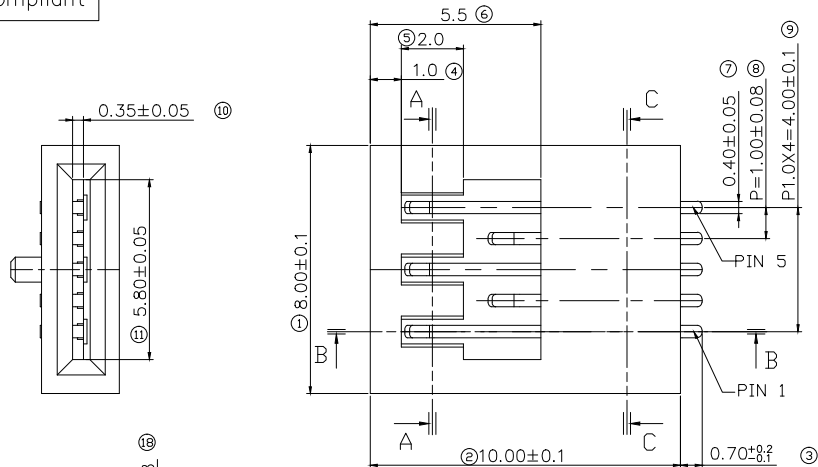
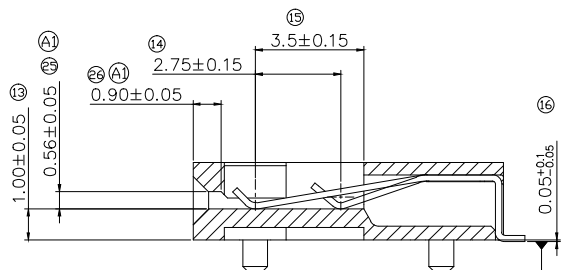
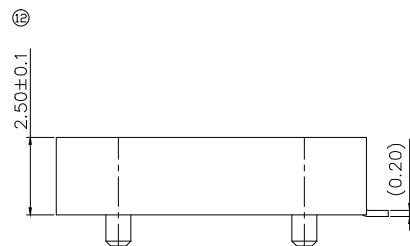

SEC B-B

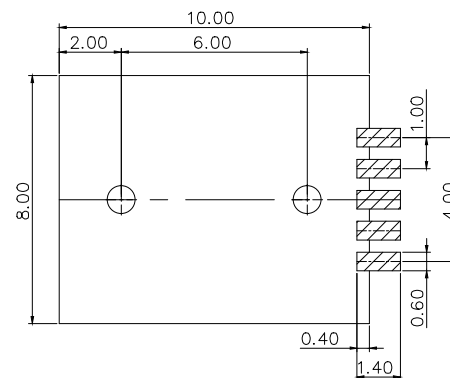

PCB LAYOUT
TOLERANCE:±0.1
LAND METAL MASK t=0.12

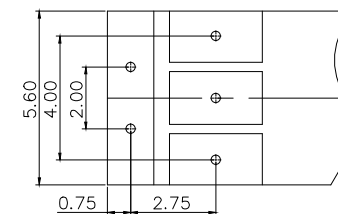

FILM CONTACT LAYOUT
TOLERANCE:±0.1

NOTE

- MATERIAL
INSULATOR:LCP E471i OR EQUIVALENT
COLOR BLACK,SELF EXTINGUISHING,UL-RATED 94 V-0
CONTACTS:PHOSPHOR BRONZE (C5191R-SH) 0.2t
- SIGNAL CONTACT PLATING
40~80μ" NICKEL UNDERPLATED OVERALL PLATED GOLD (AU 1~3μ")
- GENERAL TOLERANCE: ±0.1

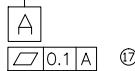

UNITS mm	NAME:	SPC 5pin				
	MAT'L	PART NO:	GP04C-06200			
	FINISH	APPD:	JASON			
	Q'TY	CHKD:	VICKY			
	DR:	DAVID		SCALE	SHEET	REV
				1:1	1 OF 1	A1

ATOM 深圳市爱特姆科技有限公司
SHENZHEN ATOM TECHNOLOGY CO., LTD.

TITLE: STRIP SOCKET CONNECTOR 5P
H=2.5 带定位柱

DWG NO. ATOM-A03458