

## Thermal Management Solutions

Products Catalog



**Guidelines and precautions regarding the technical information and use of our products described in this online catalog.**

- If you want to use our products described in this online catalog for applications requiring special qualities or reliability, or for applications where the failure or malfunction of the products may directly jeopardize human life or potentially cause personal injury (e.g. aircraft and aerospace equipment, traffic and transportation equipment, combustion equipment, medical equipment, accident prevention, anti-crime equipment, and/or safety equipment), it is necessary to verify whether the specifications of our products fit to such applications. Please ensure that you will ask and check with our inquiry desk as to whether the specifications of our products fit to such applications use before you use our products.
- The quality and performance of our products as described in this online catalog only apply to our products when used in isolation. Therefore, please ensure you evaluate and verify our products under the specific circumstances in which our products are assembled in your own products and in which our products will actually be used.
- If you use our products in equipment that requires a high degree of reliability, regardless of the application, it is recommended that you set up protection circuits and redundancy circuits in order to ensure safety of your equipment.
- The products and product specifications described in this online catalog are subject to change for improvement without prior notice. Therefore, please be sure to request and confirm the latest product specifications which explain the specifications of our products in detail, before you finalize the design of your applications, purchase, or use our products.
- The technical information in this online catalog provides examples of our products' typical operations and application circuits. We do not guarantee the non-infringement of third party's intellectual property rights and we do not grant any license, right, or interest in our intellectual property.
- If any of our products, product specifications and/or technical information in this online catalog is to be exported or provided to non-residents, the laws and regulations of the exporting country, especially with regard to security and export control, shall be observed.

**<Regarding the Certificate of Compliance with the EU RoHS Directive/REACH Regulations>**

- The switchover date for compliance with the RoHS Directive/REACH Regulations varies depending on the part number or series of our products.
- When you use the inventory of our products for which it is unclear whether those products are compliant with the RoHS Directive/REACH Regulation, please select "Sales Inquiry" in the website inquiry form and contact us.

**We do not take any responsibility for the use of our products outside the scope of the specifications, descriptions, guidelines and precautions described in this online catalog.**

# Thermal Management Solutions CONTENTS

Product Item	Part Number	Page
	The NTC Thermistors	1
Multilayer NTC Thermistors	ERT JZ	2
	ERT J0	
	ERT J1	
	Handling Precautions	10
Multilayer NTC Thermistors (Automotive Grade)	ERT J0 M	18
	ERT J1 M	23
	Handling Precautions	
“PGS” Graphite Sheets SSM(Semi-Sealing Material)	EYG S	31
	EYG A	
	EYG E	
	Minimum order	37
	Handling Precautions	39
“NASBIS” Insulating Sheet	EYG Y	41
	Handling Precautions	43
“Graphite-PAD” high thermal conductivity in z-direction	EYG T	45
	Handling Precautions	48
“GraphiteTIM (Compressible Type)” PGS with low thermal resistance	EYG S	50
	Handling Precautions	54

## The NTC Thermistors

NTC Thermistors is a negative temperature coefficient resistor that significantly reduces its resistance value as the heat/ ambient temperature rises. Thermistors is sintered in high-temperature (1200 °C to 1500 °C), and manufactured in various shapes. It's comprised of 2 to 4 kinds of metal oxides: iron, nickel, cobalt, manganese and copper.

### Features

- Temperature Coefficient of Resistance is negative, and it's extremely large (-2.8 to -5.1 [%/°C]).
- Various shapes, especially compact size components are available.
- Selection of resistance value is comparatively free, it's available from several tens Ω to several hundred kΩ.

### Recommended Applications

- For temperature measurement or temperature detection : Thermometer, temperature controller
- For temperature compensation : Transistor, transistor circuit, quartz oscillation circuit, and measuring instruments

### Physical Characteristics of NTC Thermistors

Thermistor is a resistor sensitive to temperature that is utilizing the characteristic of metal oxide semiconductor having large temperature coefficient. And its temperature dependency of resistance value is indicated by the following equation :

$$R=R_0 \exp \left[ B \left( \frac{1}{T} - \frac{1}{T_0} \right) \right] \dots\dots\dots(1)$$

$T_0$  : Standard Temperature 298.15 K(25 °C)  
 $R_0$  : Resistance at  $T_0$  [K]  
 $B$  : Thermistor Constant [K]

Temperature coefficient ( $\alpha$ ) in general meaning is indicated as follows :

$$\alpha = -\frac{B}{T^2} \dots\dots\dots(2)$$

Since the change by temperature is considerably large,  $\alpha$  is not appropriate as a constant. Therefore, B value (constant) is generally used as a coefficient of thermistors.

### Major Characteristics of NTC Thermistors

The relation between resistance and temperature of a thermistor is linear as shown in Fig. 2. The resistance value is shown in vertical direction in a logarithmic scale and reciprocal of absolute temperature (adding 273.15 to centigrade) is shown in horizontal direction.

The B value (constant) determines the gradient of these straight lines. The B value (constant) is calculated by using following equation.

$$B = \frac{\ln R_1 - \ln R_2}{\frac{1}{T_1} - \frac{1}{T_2}} \dots\dots\dots(3)$$

$R_1$ : Resistance at  $T_1$  K  
 $R_2$ : Resistance at  $T_2$  K

When you calculate this equation, you'll find that B value is not exactly constant. The resistance is expressed by the following equation :

$$R = AT^{-C} \exp D/T \dots\dots\dots(4)$$

In (4), C is a small positive or negative constant and quite negligible except for use in precision temperature-measuring device, therefore, the B value can be considered as constant number.

In Fig. 1, the relation between the resistance ratio  $R_T/R_{25}$  ( $R_{25}$ : Resistance at 25 °C,  $R_T$ : Resistance at T °C) and B Value is shown with T °C, in the horizontal direction.

Fig. 1



Fig. 2

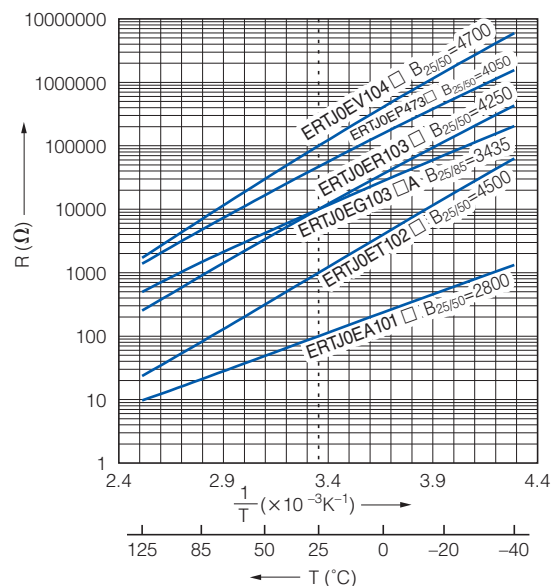

## Multilayer NTC Thermistors

Series: **ERTJ**



### Features

- Surface Mount Device (0201, 0402, 0603)
- Highly reliable multilayer / monolithic structure
- Wide temperature operating range (-40 to 125 °C)
- Environmentally-friendly lead-free
- RoHS compliant

### Recommended Applications

- Mobile Phone
  - Temperature compensation for crystal oscillator
  - Temperature compensation for semiconductor devices
- Personal Computer and Peripheral Device
  - Temperature detection for CPU and memory device
  - Temperature compensation for ink-viscosity (Inkjet Printer)
- Battery Pack (secondary battery)
  - Temperature detection of battery cells
- Liquid Crystal Display
  - Temperature compensation of display contrast
  - Temperature compensation of display backlighting (CCFL)

### Explanation of Part Numbers



### Construction



No.	Name	
①	Semiconductive Ceramics	
②	Internal electrode	
③	Terminal electrode	Substrate electrode
④		Intermediate electrode
⑤		External electrode



## Ratings

Size code (EIA)	Z(0201)	O(0402)	1(0603)
Operating Temperature Range	-40 to 125 °C		
Rated Maximum Power Dissipation*1	33 mW	66 mW	100 mW
Dissipation Factor*2	Approximately 1 mW/°C	Approximately 2 mW/°C	Approximately 3 mW/°C

- \*1 Rated Maximum Power Dissipation : The maximum power that can be continuously applied at the rated ambient temperature.  
 ·The maximum value of power, and rated power is same under the condition of ambient temperature 25 °C or less. If the temperature exceeds 25 °C, rated power depends on the decreased power dissipation curve.  
 ·Please see "Operating Power" for details.
- \*2 Dissipation factor : The constant amount power required to raise the temperature of the Thermistor 1 °C through self heat generation under stable temperatures.  
 ·Dissipation factor is the reference value when mounted on a glass epoxy board (1.6 mmT).

## Part Number List of Narrow Tolerance Type (Resistance Tolerance : ±2 %, ±1 %)

### ● 0201(EIA)

Part Number	Nominal Resistance at 25 °C	Resistance Tolerance	B Value at 25/50(K)	B Value at 25/85(K)
ERTJZEG103□A	10 kΩ	±1 % (F) or ±2 % (G)	(3380 K)	3435 K±1%
ERTJZEP473□	47 kΩ		4050 K±1 %	(4100 K)
ERTJZEP683□	68 kΩ		4050 K±1 %	(4100 K)
ERTJZER683□	68 kΩ		4250 K±1 %	(4300 K)
ERTJZER104□	100 kΩ		4250 K±1 %	(4300 K)
ERTJZET104□	100 kΩ		4500 K±1 %	(4550 K)
ERTJZEV104□	100 kΩ		4700 K±1 %	(4750 K)

□ : Resistance Tolerance Code

### ● 0402(EIA)

Part Number	Nominal Resistance at 25 °C	Resistance Tolerance	B Value at 25/50(K)	B Value at 25/85(K)
ERTJ0EG103□A	10 kΩ	±1 % (F) or ±2 % (G)	(3380 K)	3435 K±1 %
ERTJ0EP333□	33 kΩ		4050 K±1 %	(4100 K)
ERTJ0EP473□	47 kΩ		4050 K±1 %	(4100 K)
ERTJ0EP683□	68 kΩ		4050 K±1 %	(4100 K)
ERTJ0ER104□	100 kΩ		4250 K±1 %	(4300 K)
ERTJ0ES104□	100 kΩ		4330 K±1 %	(4390 K)
ERTJ0EV104□	100 kΩ		4700 K±1 %	(4750 K)
ERTJ0EV224□	220 kΩ		4700 K±1 %	(4750 K)

□ : Resistance Tolerance Code

### ● 0603(EIA)

Part Number	Nominal Resistance at 25 °C	Resistance Tolerance	B Value at 25/50(K)	B Value at 25/85(K)
ERTJ1VG103□A	10 kΩ	±1 % (F) or ±2 % (G)	(3380 K)	3435 K±1 %
ERTJ1VS104□A	100 kΩ		(4330 K)	4390 K±1 %

□ : Resistance Tolerance Code

## Part Number List of Standard Type (Resistance Tolerance : ±5 %, ±3 %)

### ● 0201(EIA)

Part Number	Nominal Resistance at 25 °C	Resistance Tolerance	B Value at 25/50(K)	B Value at 25/85(K)
ERTJZET202□	2.0 kΩ	±3 % (H) or ±5 % (J)	4500 K±2 %	(4450 K)
ERTJZET302□	3.0 kΩ		4500 K±2 %	(4450 K)
ERTJZET472□	4.7 kΩ		4500 K±2 %	(4450 K)
ERTJZEG103□A	10 kΩ		(3380 K)	3435 K±1 %
ERTJZEP473□	47 kΩ		4050 K±2 %	(4100 K)
ERTJZEP683□	68 kΩ		4050 K±2 %	(4100 K)
ERTJZER683□	68 kΩ		4250 K±2 %	(4300 K)
ERTJZER104□	100 kΩ		4250 K±2 %	(4300 K)
ERTJZET104□	100 kΩ		4500 K±2 %	(4550 K)
ERTJZEV104□	100 kΩ		4700 K±2 %	(4750 K)
ERTJZET154□	150 kΩ		4500 K±2 %	(4750 K)
ERTJZET224□	220 kΩ		4500 K±2 %	(4750 K)

□ : Resistance Tolerance Code

● 0402(EIA)

Part Number	Nominal Resistance at 25 °C	Resistance Tolerance	B Value at 25/50(K)	B Value at 25/85(K)
ERTJ0EA220□	22 Ω	±3 % (H) or ±5 % (J)	2750 K±3 %	(2700 K)
ERTJ0EA330□	33 Ω		2750 K±3 %	(2700 K)
ERTJ0EA400□	40 Ω		2750 K±3 %	(2700 K)
ERTJ0EA470□	47 Ω		2750 K±3 %	(2700 K)
ERTJ0EA680□	68 Ω		2800 K±3 %	(2750 K)
ERTJ0EA101□	100 Ω		2800 K±3 %	(2750 K)
ERTJ0EA151□	150 Ω		2800 K±3 %	(2750 K)
ERTJ0ET102□	1.0 kΩ		4500 K±2 %	(4450 K)
ERTJ0ET152□	1.5 kΩ		4500 K±2 %	(4450 K)
ERTJ0ET202□	2.0 kΩ		4500 K±2 %	(4450 K)
ERTJ0ET222□	2.2 kΩ		4500 K±2 %	(4450 K)
ERTJ0ET302□	3.0 kΩ		4500 K±2 %	(4450 K)
ERTJ0ER332□	3.3 kΩ		4250 K±2 %	(4300 K)
ERTJ0ET332□	3.3 kΩ		4500 K±2 %	(4450 K)
ERTJ0ET472□	4.7 kΩ		4500 K±2 %	(4450 K)
ERTJ0ER472□	4.7 kΩ		4250 K±2 %	(4300 K)
ERTJ0ER682□	6.8 kΩ		4250 K±2 %	(4300 K)
ERTJ0EG103□A	10 kΩ		(3380 K)	3435 K±1 %
ERTJ0EM103□	10 kΩ		3900 K±2 %	(3970 K)
ERTJ0ER103□	10 kΩ		4250 K±2 %	(4300 K)
ERTJ0ER153□	15 kΩ		4250 K±2 %	(4300 K)
ERTJ0ER223□	22 kΩ		4250 K±2 %	(4300 K)
ERTJ0EP333□	33 kΩ		4050 K±2 %	(4100 K)
ERTJ0ER333□	33 kΩ		4250 K±2 %	(4300 K)
ERTJ0ET333□	33 kΩ		4500 K±2 %	(4580 K)
ERTJ0EP473□	47 kΩ		4050 K±2 %	(4100 K)
ERTJ0ET473□	47 kΩ		4500 K±2 %	(4550 K)
ERTJ0EV473□	47 kΩ		4700 K±2 %	(4750 K)
ERTJ0EP683□	68 kΩ		4050 K±2 %	(4100 K)
ERTJ0ER683□	68 kΩ		4250 K±2 %	(4300 K)
ERTJ0EV683□	68 kΩ		4700 K±2 %	(4750 K)
ERTJ0EP104□	100 kΩ		4050 K±2 %	(4100 K)
ERTJ0ER104□	100 kΩ	4250 K±2 %	(4300 K)	
ERTJ0ES104□	100 kΩ	4330 K±2 %	(4390 K)	
ERTJ0ET104□	100 kΩ	4500 K±2 %	(4580 K)	
ERTJ0EV104□	100 kΩ	4700 K±2 %	(4750 K)	
ERTJ0ET154□	150 kΩ	4500 K±2 %	(4580 K)	
ERTJ0EV154□	150 kΩ	4700 K±2 %	(4750 K)	
ERTJ0EV224□	220 kΩ	4700 K±2 %	(4750 K)	
ERTJ0EV334□	330 kΩ	4700 K±2 %	(4750 K)	
ERTJ0EV474□	470 kΩ	4700 K±2 %	(4750 K)	

□ : Resistance Tolerance Code

● 0603(EIA)

Part Number	Nominal Resistance at 25 °C	Resistance Tolerance	B Value at 25/50(K)	B Value at 25/85(K)
ERTJ1VA220□	22 Ω	±3 %(H) or ±5 %(J)	2750 K±3 %	(2700 K)
ERTJ1VA330□	33 Ω		2750 K±3 %	(2700 K)
ERTJ1VA400□	40 Ω		2800 K±3 %	(2750 K)
ERTJ1VA470□	47 Ω		2800 K±3 %	(2750 K)
ERTJ1VA680□	68 Ω		2800 K±3 %	(2750 K)
ERTJ1VA101□	100 Ω		2800 K±3 %	(2750 K)
ERTJ1VT102□	1.0 kΩ		4500 K±2 %	(4450 K)
ERTJ1VT152□	1.5 kΩ		4500 K±2 %	(4450 K)
ERTJ1VT202□	2.0 kΩ		4500 K±2 %	(4450 K)
ERTJ1VT222□	2.2 kΩ		4500 K±2 %	(4450 K)
ERTJ1VT302□	3.0 kΩ		4500 K±2 %	(4450 K)
ERTJ1VT332□	3.3 kΩ		4500 K±2 %	(4450 K)
ERTJ1VR332□	3.3 kΩ		4250 K±2 %	(4300 K)
ERTJ1VR472□	4.7 kΩ		4250 K±2 %	(4300 K)
ERTJ1VT472□	4.7 kΩ		4500 K±2 %	(4450 K)
ERTJ1VR682□	6.8 kΩ		4250 K±2 %	(4300 K)
ERTJ1VG103□A	10 kΩ		(3380 K)	3435 K±1%
ERTJ1VR103□	10 kΩ		4250 K±2 %	(4300 K)
ERTJ1VR153□	15 kΩ		4250 K±2 %	(4300 K)
ERTJ1VR223□	22 kΩ		4250 K±2 %	(4300 K)
ERTJ1VR333□	33 kΩ		4250 K±2 %	(4300 K)
ERTJ1VP473□	47 kΩ		4100 K±2 %	(4150 K)
ERTJ1VR473□	47 kΩ		4250 K±2 %	(4300 K)
ERTJ1VV473□	47 kΩ		4700 K±2 %	(4750 K)
ERTJ1VR683□	68 kΩ		4250 K±2 %	(4300 K)
ERTJ1VV683□	68 kΩ		4700 K±2 %	(4750 K)
ERTJ1VS104□A	100 kΩ		(4330 K)	4390 K±1%
ERTJ1VV104□	100 kΩ		4700 K±2 %	(4750 K)
ERTJ1VV154□	150 kΩ		4700 K±2 %	(4750 K)
ERTJ1VT224□	220 kΩ		4500 K±2 %	(4580 K)

□ : Resistance Tolerance Code



● Temperature and Resistance value (the resistance value at 25 °C is set to 1)/ Reference values

	ERTJ□□A~		ERTJ□□G~	ERTJ□□M~	ERTJ□□P~	ERTJ□□R~	ERTJ0ES~	ERTJ1VS~	ERTJ□□T~	ERTJ□□T~	ERTJ□□V~
B <sub>25/50</sub>	2750 K	2800 K	(3375 K)	3900 K	4050 K	4250 K	4330 K	(4330 K)	4500 K	4500 K	4700 K
B <sub>25/85</sub>	(2700 K)	(2750 K)	3435 K	(3970 K)	(4100 K)	(4300 K)	(4390 K)	4390 K	(4450 K)	(4580 K)	(4750 K)
T(°C)									*1	*2	
-40	13.05	13.28	20.52	32.11	33.10	43.10	45.67	45.53	63.30	47.07	59.76
-35	10.21	10.40	15.48	23.29	24.03	30.45	32.08	31.99	42.92	33.31	41.10
-30	8.061	8.214	11.79	17.08	17.63	21.76	22.80	22.74	29.50	23.80	28.61
-25	6.427	6.547	9.069	12.65	13.06	15.73	16.39	16.35	20.53	17.16	20.14
-20	5.168	5.261	7.037	9.465	9.761	11.48	11.91	11.89	14.46	12.49	14.33
-15	4.191	4.261	5.507	7.147	7.362	8.466	8.743	8.727	10.30	9.159	10.31
-10	3.424	3.476	4.344	5.444	5.599	6.300	6.479	6.469	7.407	6.772	7.482
-5	2.819	2.856	3.453	4.181	4.291	4.730	4.845	4.839	5.388	5.046	5.481
0	2.336	2.362	2.764	3.237	3.312	3.582	3.654	3.650	3.966	3.789	4.050
5	1.948	1.966	2.227	2.524	2.574	2.734	2.778	2.776	2.953	2.864	3.015
10	1.635	1.646	1.806	1.981	2.013	2.102	2.128	2.126	2.221	2.179	2.262
15	1.380	1.386	1.474	1.567	1.584	1.629	1.642	1.641	1.687	1.669	1.710
20	1.171	1.174	1.211	1.247	1.255	1.272	1.277	1.276	1.293	1.287	1.303
25	1	1	1	1	1	1	1	1	1	1	1
30	0.8585	0.8565	0.8309	0.8072	0.8016	0.7921	0.7888	0.7890	0.7799	0.7823	0.7734
35	0.7407	0.7372	0.6941	0.6556	0.6461	0.6315	0.6263	0.6266	0.6131	0.6158	0.6023
40	0.6422	0.6376	0.5828	0.5356	0.5235	0.5067	0.5004	0.5007	0.4856	0.4876	0.4721
45	0.5595	0.5541	0.4916	0.4401	0.4266	0.4090	0.4022	0.4025	0.3874	0.3884	0.3723
50	0.4899	0.4836	0.4165	0.3635	0.3496	0.3319	0.3251	0.3254	0.3111	0.3111	0.2954
55	0.4309	0.4238	0.3543	0.3018	0.2881	0.2709	0.2642	0.2645	0.2513	0.2504	0.2356
60	0.3806	0.3730	0.3027	0.2518	0.2386	0.2222	0.2158	0.2161	0.2042	0.2026	0.1889
65	0.3376	0.3295	0.2595	0.2111	0.1985	0.1832	0.1772	0.1774	0.1670	0.1648	0.1523
70	0.3008	0.2922	0.2233	0.1777	0.1659	0.1518	0.1463	0.1465	0.1377	0.1348	0.1236
75	0.2691	0.2600	0.1929	0.1504	0.1393	0.1264	0.1213	0.1215	0.1144	0.1108	0.1009
80	0.2417	0.2322	0.1672	0.1278	0.1174	0.1057	0.1011	0.1013	0.09560	0.09162	0.08284
85	0.2180	0.2081	0.1451	0.1090	0.09937	0.08873	0.08469	0.08486	0.08033	0.07609	0.06834
90	0.1974	0.1871	0.1261	0.09310	0.08442	0.07468	0.07122	0.07138	0.06782	0.06345	0.05662
95	0.1793	0.1688	0.1097	0.07980	0.07200	0.06307	0.06014	0.06028	0.05753	0.05314	0.04712
100	0.1636	0.1528	0.09563	0.06871	0.06166	0.05353	0.05099	0.05112	0.04903	0.04472	0.03939
105	0.1498	0.1387	0.08357	0.05947	0.05306	0.04568	0.04340	0.04351	0.04198	0.03784	0.03308
110	0.1377	0.1263	0.07317	0.05170	0.04587	0.03918	0.03708	0.03718	0.03609	0.03218	0.02791
115	0.1270	0.1153	0.06421	0.04512	0.03979	0.03374	0.03179	0.03188	0.03117	0.02748	0.02364
120	0.1175	0.1056	0.05650	0.03951	0.03460	0.02916	0.02734	0.02742	0.02702	0.02352	0.02009
125	0.1091	0.09695	0.04986	0.03470	0.03013	0.02527	0.02359	0.02367	0.02351	0.02017	0.01712

\*1 Apply to products with a B<sub>25/50</sub> constant of 4500 K and a resistance value of 25 °C less than 10 kΩ. \*2 Applied only to ERTJ0ET104□.

\*2 Apply to products with a B<sub>25/50</sub> constant of 4500 K and a resistance value of 25 °C of 10 kΩ or more. \*2 Applied only to ERTJ0ET104□.

$$B_{25/50} = \frac{\ln(R_{25}/R_{50})}{1/298.15 - 1/323.15}$$

$$B_{25/85} = \frac{\ln(R_{25}/R_{85})}{1/298.15 - 1/358.15}$$

R<sub>25</sub>=Resistance at 25.0±0.1 °C

R<sub>50</sub>=Resistance at 50.0±0.1 °C

R<sub>85</sub>=Resistance at 85.0±0.1 °C

## Specification and Test Method

Item	Specification	Test Method									
Rated Zero-power Resistance (R <sub>25</sub> )	Within the specified tolerance.	The value is measured at a power that the influence of self-heat generation can be negligible (0.1mW or less), at the rated ambient temperature of 25.0±0.1°C.									
B Value	Shown in each Individual Specification. * Individual Specification shall specify B <sub>25/50</sub> or B <sub>25/85</sub> .	<p>The Zero-power resistances; R<sub>1</sub> and R<sub>2</sub>, shall be measured respectively at T<sub>1</sub> (deg.C) and T<sub>2</sub> (deg.C). The B value is calculated by the following equation.</p> $B_{T_1/T_2} = \frac{\ln(R_1) - \ln(R_2)}{1/(T_1 + 273.15) - 1/(T_2 + 273.15)}$ <table border="1"> <thead> <tr> <th></th> <th>T<sub>1</sub></th> <th>T<sub>2</sub></th> </tr> </thead> <tbody> <tr> <td>B<sub>25/50</sub></td> <td>25.0 ±0.1 °C</td> <td>50.0 ±0.1 °C</td> </tr> <tr> <td>B<sub>25/85</sub></td> <td>25.0 ±0.1 °C</td> <td>85.0 ±0.1 °C</td> </tr> </tbody> </table>		T <sub>1</sub>	T <sub>2</sub>	B <sub>25/50</sub>	25.0 ±0.1 °C	50.0 ±0.1 °C	B <sub>25/85</sub>	25.0 ±0.1 °C	85.0 ±0.1 °C
	T <sub>1</sub>	T <sub>2</sub>									
B <sub>25/50</sub>	25.0 ±0.1 °C	50.0 ±0.1 °C									
B <sub>25/85</sub>	25.0 ±0.1 °C	85.0 ±0.1 °C									
Adhesion	The terminal electrode shall be free from peeling or signs of peeling.	<p>Applied force : Size 0201 : 2 N Size 0402, 0603 : 5 N Duration : 10 s</p> <p>Size : 0201, 0402</p>  <p>Size : 0603</p>  <p>Unit : mm</p>									
Bending Strength	There shall be no cracks and other mechanical damage. R <sub>25</sub> change : within ±5 %	<p>Bending distance : 1 mm Bending speed : 1 mm/s</p>  <p>Unit : mm</p>									
Resistance to Soldering Heat	There shall be no cracks and other mechanical damage. Narrow Tol. type    Standard type R <sub>25</sub> change : within ±2 %    within ±3 % B Value change : within ±1 %    within ±2 %	<p>Soldering bath method Solder temperature : 270 ±5 °C Dipping period : 4.0 ±1 s Preheat condition :</p> <table border="1"> <thead> <tr> <th>Step</th> <th>Temp (°C)</th> <th>Period (s)</th> </tr> </thead> <tbody> <tr> <td>1</td> <td>80 to 100</td> <td>120 to 180</td> </tr> <tr> <td>2</td> <td>150 to 200</td> <td>120 to 180</td> </tr> </tbody> </table>	Step	Temp (°C)	Period (s)	1	80 to 100	120 to 180	2	150 to 200	120 to 180
Step	Temp (°C)	Period (s)									
1	80 to 100	120 to 180									
2	150 to 200	120 to 180									
Solderability	More than 95 % of the soldered area of both terminal electrodes shall be covered with fresh solder.	<p>Soldering bath method Solder temperature : 230 ±5 °C Dipping period : 4 ±1 s Solder : Sn-3.0Ag-0.5Cu</p>									

## Specification and Test Method

Item	Specification		Test Method
Temperature Cycling	Narrow Tol. type R <sub>25</sub> change : within ±2 % B Value change : within ±1 %	Standard type within ±3 % within ±2 %	Conditions of one cycle Step 1 : -40 °C, 30±3 min Step 2 : Room temp., 3 min max. Step 3 : 125 °C, 30±3 min. Step 4 : Room temp., 3 min max. Number of cycles: 100 cycles
Humidity	Narrow Tol. type R <sub>25</sub> change : within ±2 % B Value change : within ±1 %	Standard type within ±3 % within ±2 %	Temperature : 85 ±2 °C Relative humidity : 85 ±5 % Test period : 1000 +48/0 h
Biased Humidity	Narrow Tol. type R <sub>25</sub> change : within ±2 % B Value change : within ±1 %	Standard type within ±3 % within ±2 %	Temperature : 85 ±2 °C Relative humidity : 85 ±5 % Applied power : 10 mW(D.C.) Test period : 500 +48/0 h
Low Temperature Exposure	Narrow Tol. type R <sub>25</sub> change : within ±2 % B Value change : within ±1 %	Standard type within ±3 % within ±2 %	Specimens are soldered on the testing board shown in Fig.2. Temperature : -40 ±3 °C Test period : 1000 +48/0 h
High Temperature Exposure	Narrow Tol. type R <sub>25</sub> change : within ±2 % B Value change : within ±1 %	Standard type within ±3 % within ±2 %	Specimens are soldered on the testing board shown in Fig.2. Temperature : 125 ±3 °C Test period : 1000 +48/0 h

## Typical Application

### ● Temperature Detection

Writing current control of HDD

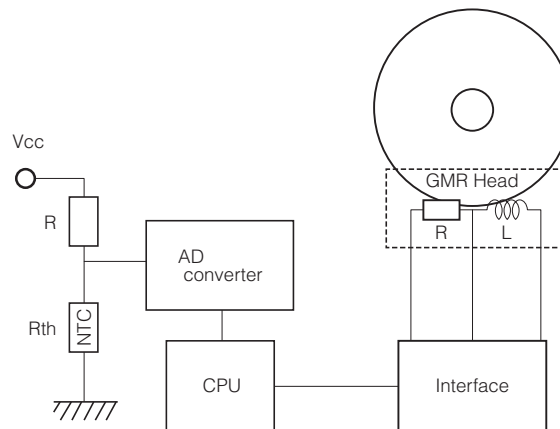

### ● Temperature Compensation (Pseudo-linearization)

Contrast level control of LCD

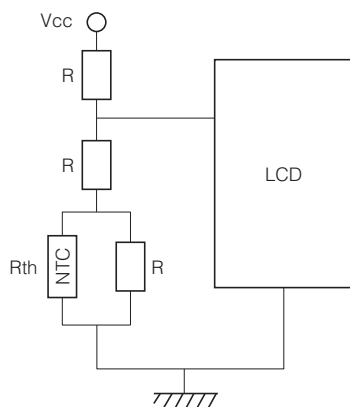

### ● Temperature Compensation (RF circuit)

Temperature compensation of TCXO

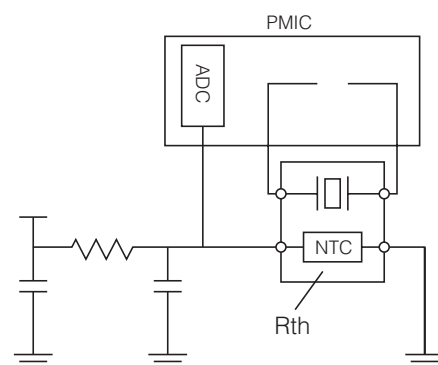

## Dimensions in mm (not to scale)



(Unit : mm)

Size Code (EIA)	L	W	T	L <sub>1</sub> , L <sub>2</sub>
Z(0201)	0.60±0.03	0.30±0.03	0.30±0.03	0.15±0.05
0(0402)	1.0±0.1	0.50±0.05	0.50±0.05	0.25±0.15
1(0603)	1.60±0.15	0.8±0.1	0.8±0.1	0.3±0.2

## Packaging Methods

### ● Standard Packing Quantities

Size Code	Thickness (mm)	Kind of Taping	Pitch (mm)	Quantity (pcs./reel)
Z(0201)	0.3	Pressed Carrier Taping	2	15,000
0(0402)	0.5	Punched Carrier Taping	2	10,000
1(0603)	0.8		4	4,000

### ● Pitch 2 mm (Pressed Carrier Taping) : Size 0201



Symbol	A	B	W	F	E	P <sub>1</sub>	P <sub>2</sub>	P <sub>0</sub>	φD <sub>0</sub>	t	K <sub>0</sub>
Dim. (mm)	0.36 ±0.03	0.66 ±0.03	8.0 ±0.2	3.50 ±0.05	1.75 ±0.10	2.00 ±0.05	2.00 ±0.05	4.0 ±0.1	1.5 <sup>+0.1</sup> <sub>0</sub>	0.55 max.	0.36 ±0.03

### ● Pitch 2 mm (Punched Carrier Taping) : Size 0402



Symbol	A	B	W	F	E	P <sub>1</sub>	P <sub>2</sub>	P <sub>0</sub>	φD <sub>0</sub>	t <sub>1</sub>	t <sub>2</sub>
Dim. (mm)	0.62 ±0.05	1.12 ±0.05	8.0 ±0.2	3.50 ±0.05	1.75 ±0.10	2.00 ±0.05	2.00 ±0.05	4.0 ±0.1	1.5 <sup>+0.1</sup> <sub>0</sub>	0.7 max.	1.0 max.

### ● Pitch 4 mm (Punched Carrier Taping) : Size 0603



Symbol	A	B	W	F	E	P <sub>1</sub>	P <sub>2</sub>	P <sub>0</sub>	φD <sub>0</sub>	t <sub>1</sub>	t <sub>2</sub>
Dim. (mm)	1.0 ±0.1	1.8 ±0.1	8.0 ±0.2	3.50 ±0.05	1.75 ±0.10	4.0 ±0.1	2.00 ±0.05	4.0 ±0.1	1.5 <sup>+0.1</sup> <sub>0</sub>	1.1 max.	1.4 max.

### ● Reel for Taping



Symbol	φA	φB	C	D	E	W <sub>1</sub>	W <sub>2</sub>
Dim. (mm)	180 <sup>-0</sup> <sub>3</sub>	60.0 <sup>+1.0</sup> <sub>0</sub>	13.0±0.5	21.0±0.8	2.0±0.5	9.0 <sup>+1.0</sup> <sub>0</sub>	11.4±1.0

### ● Leader Part and Taped End

#### Leader part



#### Taped end



(Unit : mm)

## Minimum Quantity / Packing Unit

Part Number (Size)	Minimum Quantity / Packing Unit	Packing Quantity in Carton	Carton L×W×H (mm)
ERTJZ (0201)	15,000	300,000	250×200×200
ERTJ0 (0402)	10,000	200,000	250×200×200
ERTJ1 (0603)	4,000	80,000	250×200×200

Part No., quantity and country of origin are designated on outer packages in English.

## Multilayer NTC Thermistors

Series: ERTJ

### Handling Precautions

#### [Precautions]

- **Do not use the products beyond the descriptions in this product catalog.**
- **This product catalog guarantees the quality of the products as individual components. Before you use the products, please make sure to check and evaluate the products in the circumstance where they are installed in your product.**

#### Safety Precautions

Multilayer NTC Thermistors for General Applications (hereafter referred to as “Thermistors”) are intended to be used in general-purpose applications as measures against Temperature detection and Temperature compensation in consumer electronics (audio/visual, home, office, information & communication) equipment. When subjected to severe electrical, environmental, and/or mechanical stress beyond the specifications, as noted in the Ratings and Specified Conditions section, the Thermistors’ performance may be degraded, or become failure mode, such as short circuit mode and open-circuit mode.

If you use under the condition of short-circuit, heat generation of Thermistors will occur by running large current due to application of voltage. There are possibilities of smoke emission, substrate burn-out, and, in the worst case, fire. For products which require high safety levels, please carefully consider how a single malfunction can affect your product. In order to ensure the safety in the case of a single malfunction, please design products with fail-safe, such as setting up protecting circuits, etc.

We are trying to improve the quality and the reliability, but the durability differs depending on the use environment and the use conditions. On use, be sure to confirm the actual product under the actual use conditions.

- For the following applications and conditions, please be sure to consult with our sales representative in advance and to exchange product specifications which conform to such applications.
  - When your application may have difficulty complying with the safety or handling precautions specified below.
  - High-quality and high-reliability required devices that have possibility of causing hazardous conditions, such as death or injury (regardless of directly or indirectly), due to failure or malfunction of the product.
- ① Aircraft and Aerospace Equipment (artificial satellite, rocket, etc.)
- ② Submarine Equipment (submarine repeating equipment, etc.)
- ③ Transportation Equipment (motor vehicles, airplanes, trains, ship, traffic signal controllers, etc.)
- ④ Power Generation Control Equipment  
(atomic power, hydroelectric power, thermal power plant control system, etc.)
- ⑤ Medical Equipment (life-support equipment, pacemakers, dialysis controllers, etc.)
- ⑥ Information Processing Equipment (large scale computer systems, etc.)
- ⑦ Electric Heating Appliances, Combustion devices (gas fan heaters, oil fan heaters, etc.)
- ⑧ Rotary Motion Equipment
- ⑨ Security Systems
- ⑩ And any similar types of equipment

#### Strict Observance

##### 1. Confirmation of Rated Performance

The Thermistors shall be operated within the specified rating/performance.

Applications exceeding the specifications may cause deteriorated performance and/or breakdown, resulting in degradation and/or smoking or ignition of products. The following are strictly observed.

- (1) The Thermistors shall not be operated beyond the specified operating temperature range.
- (2) The Thermistors shall not be operated in excess of the specified maximum power dissipation.

##### 2. The Thermistors shall not be mounted near flammables.



## Operating Conditions and Circuit Design

### 1. Circuit Design

#### 1.1 Operating Temperature and Storage Temperature

When operating a components-mounted circuit, please be sure to observe the "Operating Temperature Range", written in delivery specifications. Storage temperature of PCB after mounting Thermistors, which is not operated, should be within the specified "Storage Temperature Range" in the delivery specifications. Please remember not to use the product under the condition that exceeds the specified maximum temperature.

#### 1.2 Operating Power

The electricity applied to between terminals of Thermistors should be under the specified maximum power dissipation. There are possibilities of breakage and burn-out due to excessive self-heating of Thermistors, if the power exceeds maximum power dissipation when operating. Please consider installing protection circuit for your circuit to improve the safety, in case of abnormal voltage application and so on. Thermistors' performance of temperature detection would be deteriorated if self-heating occurs, even when you use it under the maximum power dissipation. Please consider the maximum power dissipation and dissipation factor.

#### 【Maximum power dissipation】

- The Maximum power that can be continuously applied under static air at a certain ambient temperature. The Maximum power dissipation under an ambient temperature of 25 °C or less is the same with the rated maximum power dissipation, and Maximum power dissipation beyond 25 °C depends on the Decreased power dissipation curve below.

#### 【Dissipation factor】

- The constant amount power required to raise the temperature of the Thermistor 1 °C through self heat generation under stable temperatures.  
Dissipation factor (mW/°C) = Power consumption of Thermistor / Temperature rise of element.

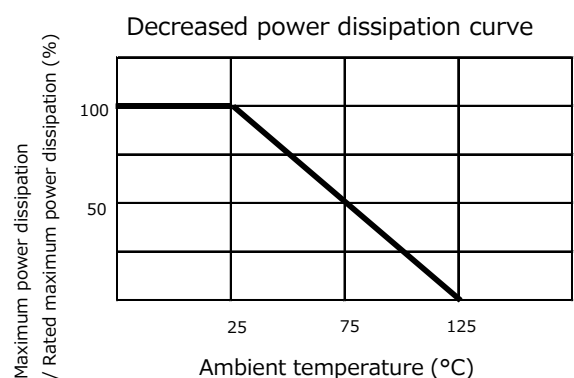

#### 1.3 Environmental Restrictions

The Thermistors does not take the use under the following special environments into consideration. Accordingly, the use in the following special environments, and such environmental conditions may affect the performance of the product; prior to use, verify the performance, reliability, etc. thoroughly.

- ① Use in liquids such as water, oil, chemical, and organic solvent.
- ② Use under direct sunlight, in outdoor or in dusty atmospheres.
- ③ Use in places full of corrosive gases such as sea breeze, Cl<sub>2</sub>, H<sub>2</sub>S, NH<sub>3</sub>, SO<sub>2</sub>, and NO<sub>x</sub>.
- ④ Use in environment with large static electricity or strong electromagnetic waves or strong radial ray.
- ⑤ Where the product is close to a heating component, or where an inflammable such as a polyvinyl chloride wire is arranged close to the product.
- ⑥ Where this product is sealed or coated with resin etc.
- ⑦ Where solvent, water, or water-soluble detergent is used in flux cleaning after soldering.  
(Pay particular attention to water-soluble flux.)
- ⑧ Use in such a place where the product is wetted due to dew condensation.
- ⑨ Use the product in a contaminated state.  
Ex.) Do not handle the product such as sticking sebum directly by touching the product after mounting printed circuit board.
- ⑩ Under severe conditions of vibration or impact beyond the specified conditions found in the Specifications.

#### 1.4 Measurement of Resistance

The resistance of the Thermistors varies depending on ambient temperatures and self-heating. To measure the resistance value when examining circuit configuration and conducting receiving inspection and so on, the following points should be taken into consideration:

- ① Measurement temp : 25±0.1 °C  
Measurement in liquid (silicon oil, etc.) is recommended for a stable measurement temperature.
- ② Power : 0.10 mW max. 4 terminal measurement with a constant-current power supply is recommended.

**2. Design of Printed Circuit Board**

**2.1 Selection of Printed Circuit Boards**

There is a possibility of performance deterioration by heat shock (temperature cycles), which causes cracks, from alumina substrate. Please confirm that the substrate you use does not deteriorate the Thermistors' quality.

**2.2 Design of Land Pattern**

(1) Recommended land dimensions are shown below. Use the proper amount of solder in order to prevent cracking. Using too much solder places excessive stress on the Thermistors..

Recommended Land Dimensions(Ex.)



Size Code/EIA	Component dimensions			Unit (mm)		
	L	W	T	a	b	c
Z(0201)	0.6	0.3	0.3	0.2 to 0.3	0.25 to 0.30	0.2 to 0.3
0(0402)	1.0	0.5	0.5	0.4 to 0.5	0.4 to 0.5	0.4 to 0.5
1(0603)	1.6	0.8	0.8	0.8 to 1.0	0.6 to 0.8	0.6 to 0.8

(2) The land size shall be designed to have equal space, on both right and left side. If the amount of solder on both sides is not equal, the component may be cracked by stress since the side with a larger amount of solder solidifies later during cooling.

**Recommended Amount of Solder**

(a) Excessive amount    (b) Proper amount    (c) Insufficient amount



**2.3 Utilization of Solder Resist**

(1) Solder resist shall be utilized to equalize the amounts of solder on both sides.

- (2) Solder resist shall be used to divide the pattern for the following cases;
- Components are arranged closely.
  - The Thermistor is mounted near a component with lead wires.
  - The Thermistor is placed near a chassis.

Refer to the table below.

**Prohibited Applications and Recommended Applications**

Item	Prohibited applications	Improved applications by pattern division
Mixed mounting with a component with lead wires	The lead wire of a Component With lead wires 	Solder resist 
Arrangement near chassis	Chassis Solder(ground solder) Electrode pattern 	Solder resist 
Retro-fitting of component with lead wires	A lead wire of Retrofitted component Soldering iron iron 	Solder resist 
Lateral arrangement	Portion to be Excessively soldered Land 	Solder resist 

**2.4 Component Layout**

To prevent the crack of Thermistors, try to place it place it on the position that could not easily be affected by the bending stress of substrate while mounting procedures or procedures afterwards. Placement of the Thermistors near heating elements also requires the great care to be taken in order to avoid stresses from rapid heating and cooling.

- (1) To minimize mechanical stress caused by the warp or bending of a PC board, please follow the recommended Thermistors' layout below.

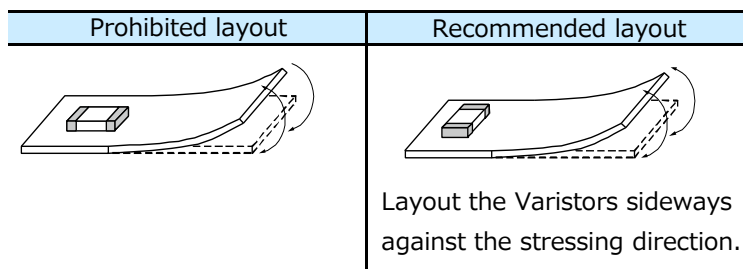

- (2) The following layout is for your reference since mechanical stress near the dividing/breaking position of a PC board varies depending on the mounting position of the Thermistors.

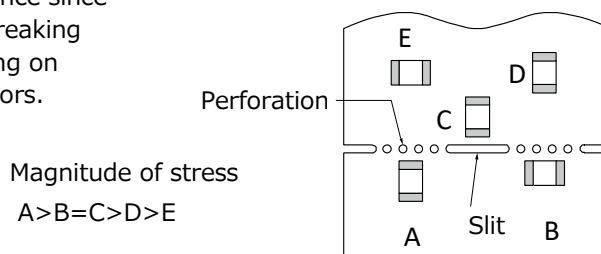

- (3) The magnitude of mechanical stress applied to the Thermistors when dividing the circuit board in descending order is as follows: push back < slit < V-groove < perforation. Also take into account the layout of the Thermistors and the dividing/breaking method.
- (4) When the Thermistors are placed near heating elements such as heater, etc., cracks from thermal stresses may occur under following situation:
- Soldering the Thermistors directly to heating elements.
  - Sharing the land with heating elements.
- If planning to conduct above-mentioned mounting and/or placement, please contact us in advance.

## 2.5 Mounting Density and Spaces

Intervals between components should not be too narrow to prevent the influence from solder bridges and solder balls. The space between components should be carefully determined.

## Precautions for Assembly

### 1. Storage

- (1) The Thermistors shall be stored between 5 to 40 °C and 20 to 70 % RH, not under severe conditions of high temperature and humidity.
- (2) If stored in a place where humidity, dust, or corrosive gasses (hydrogen sulfide, sulfurous acid, hydrogen chloride and ammonia, etc.) are contained, the solderability of terminals electrodes will be deteriorated. In addition, storage in a place where the heat or direct sunlight exposure occurs will causes or direct sunlight exposure occurs will causes mounting problems due to deformation of tapes and reels and components and taping/reels sticking together.
- (3) Do not store components longer than 6 months. Check the solderability of products that have been stored for more than 6 months before use.

### 2. Chip Mounting Consideration

- (1) When mounting the Thermistors/components on a PC board, the Thermistor bodies shall be free from excessive impact loads such as mechanical impact or stress due to the positioning, pushing force and displacement of vacuum nozzles during mounting.
- (2) Maintenance and inspection of the Chip Mounter must be performed regularly.
- (3) If the bottom dead center of the vacuum nozzle is too low, the Thermistor will crack from excessive force during mounting. The following precautions and recommendations are for your reference in use.
  - (a) Set and adjust the bottom dead center of the vacuum nozzles to the upper surface of the PC board after correcting the warp of the PC board.
  - (b) Set the pushing force of the vacuum nozzle during mounting to 1 to 3 N in static load.
  - (c) For double surface mounting, apply a supporting pin on the rear surface of the PC board to suppress the bending of the PC board in order to minimize the impact of the vacuum nozzles. Typical examples are shown in the table below.
  - (d) Adjust the vacuum nozzles so that their bottom dead center during mounting is not too low.

Item	Prohibited mounting	Recommended mounting
Single surface mounting	 Crack	 Supporting pin The supporting pin does not necessarily have to be positioned
Double surface mounting	 Separation of solder Crack	 Supporting pin

- (4) The closing dimensions of the positioning chucks shall be controlled. Maintenance and replacement of positioning chucks shall be performed regularly to prevent chipping or cracking of the Thermistors caused by mechanical impact during positioning due to worn positioning chucks.
- (5) Maximum stroke of the nozzle shall be adjusted so that the maximum bending of PC board does not exceed 0.5 mm at 90 mm span. The PC board shall be supported by an adequate number of supporting pins.

### 3. Selection of Soldering Flux

Soldering flux may seriously affect the performance of the Thermistors. The following shall be confirmed before use.

- (1) The soldering flux should have a halogen based content of 0.1 wt% (converted to chlorine) or below. Do not use soldering flux with strong acid.
- (2) When applying water-soluble soldering flux, wash the Thermistors sufficiently because the soldering flux residue on the surface of PC boards may deteriorate the insulation resistance on the Thermistors' surface.

### 4. Soldering

#### 4.1 Reflow Soldering

The reflow soldering temperature conditions are composed of temperature curves of Preheating, Temp. rise, Heating, Peak and Gradual cooling. Large temperature difference inside the Thermistors caused by rapid heat application to the Thermistors may lead to excessive thermal stresses, contributing to the thermal cracks. The Preheating temperature requires controlling with great care so that tombstone phenomenon may be prevented.

Recommended profile of Reflow Soldering (Ex.)



Item	Temperature	Period or Speed
① Preheating	140 to 180 °C	60 to 120 s
② Temp. rise	Preheating temp to Peak temp.	2 to 5 °C / s
③ Heating	220 °C min.	60 s max.
④ Peak	260 °C max.	10 s max.
⑤ Gradual cooling	Peak temp. to 140 °C	1 to 4 °C / s

$\Delta T$  : Allowable temperature difference  $\Delta T \leq 150$  °C

The rapid cooling (forced cooling) during Gradual cooling part should be avoided, because this may cause defects such as the thermal cracks, etc. When the Thermistors are immersed into a cleaning solvent, make sure that the surface temperatures of the devices do not exceed 100 °C. Performing reflow soldering twice under the conditions shown in the figure above [Recommended profile of Flow soldering (Ex.)] will not cause any problems. However, pay attention to the possible warp and bending of the PC board.

Recommended soldering condition is for the guideline for ensuring the basic characteristics of the components, not for the stable soldering conditions. Conditions for proper soldering should be set up according to individual conditions. The temperature of this product at the time of mounting changes depending on mounting conditions, therefore, please confirm that Product surface becomes the specified temperature when mounting it on the end product.

## 4.2 Hand Soldering

Hand soldering typically causes significant temperature change, which may induce excessive thermal stresses inside the Thermistors, resulting in the thermal cracks, etc. In order to prevent any defects, the following should be observed.

- The temperature of the soldering tips should be controlled with special care.
- The direct contact of soldering tips with the Thermistors and/or terminal electrodes should be avoided.
- Dismounted Thermistors shall not be reused.

### (1) Condition 1 (with preheating)

- Soldering : Use thread solder ( $\phi$  1.0 mm or below) which contains flux with low chlorine, developed for precision electronic equipment.
- Preheating : Conduct sufficient pre-heating, and make sure that the temperature difference between solder and Thermistors' surface is 150 °C or less.
- Temperature of Iron tip: 300 °C max.  
(The required amount of solder shall be melted in advance on the soldering tip.)
- Gradual cooling : After soldering, the Thermistors shall be cooled gradually at room temperature.

Recommended profile of Hand soldering (Ex.)



$\Delta T$  : Allowable temperature difference  $\Delta T \leq 150$  °C

### (2) Condition 2 (without preheating)

Hand soldering can be performed without preheating, by following the conditions below:

- Soldering iron tip shall never directly touch the ceramic and terminal electrodes of the Thermistors.
- The lands are sufficiently preheated with a soldering iron tip before sliding the soldering iron tip to the terminal electrodes of the Thermistors for soldering.

Conditions of Hand soldering without preheating

Item	Condition
Temperature of Iron tip	270 °C max.
Wattage	20 W max.
Shape of Iron tip	$\phi$ 3 mm max.
Soldering time with a soldering iron	3 s max.

## 5. Post Soldering Cleaning

### 5.1 Cleaning solvent

Soldering flux residue may remain on the PC board if cleaned with an inappropriate solvent. This may deteriorate the electrical characteristics and reliability of the Thermistors.

### 5.2 Cleaning conditions

Inappropriate cleaning conditions such as insufficient cleaning or excessive cleaning may impair the electrical characteristics and reliability of the Thermistors.

#### (1) Insufficient cleaning can lead to :

- The halogen substance found in the residue of the soldering flux may cause the metal of terminal electrodes to corrode.
- The halogen substance found in the residue of the soldering flux on the surface of the Thermistors may change resistance values.
- Water-soluble soldering flux may have more remarkable tendencies of (a) and (b) above compared to those of rosin soldering flux.

#### (2) Excessive cleaning can lead to :

- When using ultrasonic cleaner, make sure that the output is not too large, so that the substrate will not resonate. The resonance causes the cracks in Thermistors and/or solders, and deteriorates the strength of the terminal electrodes. Please follow these conditions for Ultrasonic cleaning:
  - Ultrasonic wave output : 20 W/L max.
  - Ultrasonic wave frequency : 40 kHz max.
  - Ultrasonic wave cleaning time : 5 min. max.



**5.3 Contamination of Cleaning solvent**

Cleaning with contaminated cleaning solvent may cause the same results as that of insufficient cleaning due to the high density of liberated halogen.

**6. Inspection Process**

The pressure from measuring terminal pins might bend the PCB when implementing circuit inspection after mounting Thermistors on PCB, and as a result, cracking may occur.

- (1) Mounted PC boards shall be supported by an adequate number of supporting pins on the back with bend settings of 90 mm span 0.5 mm max.
- (2) Confirm that the measuring pins have the right tip shape, are equal in height, have the right pressure and are set in the correct positions. The following figures are for your reference to avoid bending the PC board.

Item	Prohibited mounting	Recommended mounting
Bending of PC board	 <p>Separated, Crack</p>	 <p>Supporting pin</p>

**7. Protective Coating**

Make sure characteristics and reliability when using the resin coating or resin embedding for the purpose of improvement of humidity resistance or gas resistance, or fixing of parts because failures of a thermistors such as 1) ,2) and 3) may be occurred.

- (1) The solvent which contained in the resin permeate into the Thermistors, and it may deteriorate the characteristic.
- (2) When hardening the resin, chemical reaction heat (curing heat generation) happen and it may occurs the infection to the Thermistors.
- (3) The lead wire might be cut down and the soldering crack might be happen by expansion or contraction of resin hardening.

**8. Dividing/Breaking of PC Boards**

- (1) Please be careful not to stress the substrate with bending/twisting when dividing, after mounting components including Thermistors. Abnormal and excessive mechanical stress such as bending or torsion shown below can cause cracking in the Thermistors.

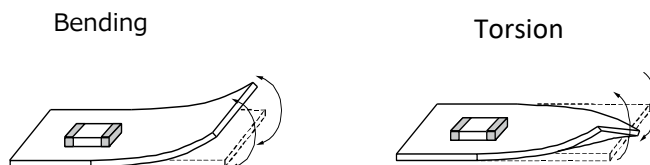

- (2) Dividing/Breaking of the PC boards shall be done carefully at moderate speed by using a jig or apparatus to prevent the Thermistors on the boards from mechanical damage.
- (3) Examples of PCB dividing/breaking jigs: The outline of PC board breaking jig is shown below. When PC board are broken or divided, loading points should be close to the jig to minimize the extent of the bending. Also, planes with no parts mounted on should be used as plane of loading, in order to prevent tensile stress induced by the bending, which may cause cracks of the Thermistors or other parts mounted on the PC boards.

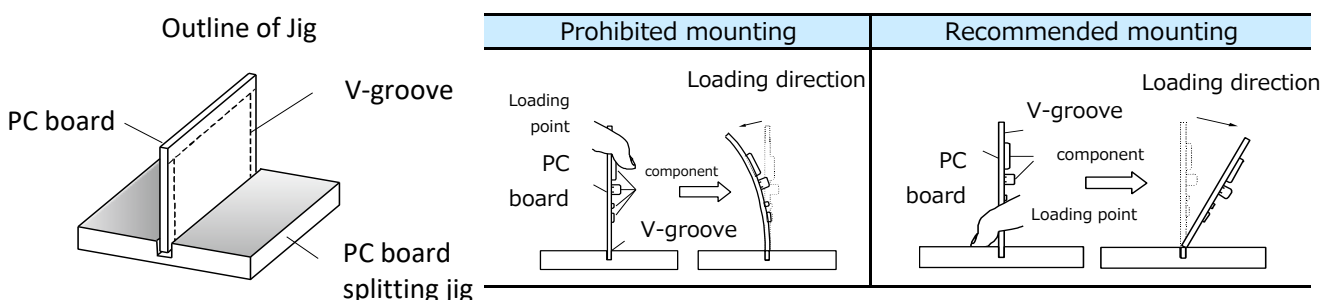

## 10. Mechanical Impact

- (1) The Thermistors shall be free from any excessive mechanical impact.

The Thermistor body is made of ceramics and may be damaged or cracked if dropped. Never use a Thermistor which has been dropped; their quality may already be impaired, and in that case, failure rate will increase.

- (2) When handling PC boards with Thermistors mounted on them, do not allow the Thermistors to collide with another PC board.

When mounted PC boards are handled or stored in a stacked state, the corner of a PC board might strike Thermistors, and the impact of the strike may cause damage or cracking and can deteriorate the withstand voltage and insulation resistance of the Thermistors.



- 11.** Do not reuse this product after removal from the mounting board.

## Precautions for discarding

As to the disposal of the Thermistors, check the method of disposal in each country or region where the modules are incorporated in your products to be used.

## Other

The Thermistors precautions described above are typical. For special mounting conditions, please contact us. The technical information in this catalog provides example of our products' typical operations and application circuit.

## Applicable laws and regulations , others

1. This product not been manufactured with any ozone depleting chemical controlled under the Montreal Protocol.
2. This product comply with RoHS(Restriction of the use of certain Hazardous Substance in electrical and electronic equipment) (DIRECTIVE 2011/65/EU and 2015/863/EU).
3. All the materials used in this part are registered material under the Law Concerning the Examination and Regulation of Manufacture, etc. of Chemical Substance.
4. If you need the notice by letter of "A preliminary judgement on the Laws of Japan foreign exchange and Foreign Trade Control", be sure to let us know.
5. These products are not dangerous goods on the transportation as identified by UN (United nations) numbers or UN classification.
6. The technical information in this catalog provides example of our products' typical operations and application circuit. We do not guarantee the non-infringement of third party's intellectual property rights and we do not grant any license, Right or interest in our intellectual property.

## Multilayer NTC Thermistors (Automotive Grade)

Series: **ERTJ-M**



### Features

- Surface Mount Device (0402, 0603)
- Highly reliable multilayer / monolithic structure
- Wide temperature operating range (−40 to 150 °C)
- Environmentally-friendly lead-free
- AEC-Q200 qualified
- RoHS compliant

### Recommended Applications

- For car audio system
- For ECUs
- For electric pumps and compressors
- For LED lights
- For batteries
- For temperature detection of various circuits

### Explanation of Part Numbers



### Construction



No.	Name	
①	Semiconductive Ceramics	
②	Internal electrode	
③	Terminal electrode	Substrate electrode
④		Intermediate electrode
⑤		External electrode

Ratings		
Size code (EIA)	0(0402)	1(0603)
Operating Temperature Range	-40 to 150 °C	
Rated Maximum Power Dissipation*1	66 mW	100 mW
Dissipation Factor*2	Approximately 2 mW/°C	Approximately 3 mW/°C

- \*1 Rated Maximum Power Dissipation : The maximum power that can be continuously applied at the rated ambient temperature.  
 · The maximum value of power, and rated power is same under the condition of ambient temperature 25 °C or less. If the temperature exceeds 25 °C, rated power depends on the decreased power dissipation curve.  
 · Please see "Operating Power" for details.
- \*2 Dissipation factor : The constant amount power required to raise the temperature of the Thermistor 1 °C through self heat generation under stable temperatures.  
 · Dissipation factor is the reference value when mounted on a glass epoxy board (1.6 mmT).

## Part Number List

### ● 0402(EIA)

Part Number	Nominal Resistance at 25 °C	B Value at 25/50(K)	B Value at 25/85(K)
ERTJ0EG202GM	2 kΩ±2 %	(3380 K)	3410 K±0.5 %
ERTJ0EG202HM	2 kΩ±3 %	(3380 K)	3410 K±0.5 %
ERTJ0EG202JM	2 kΩ±5 %	(3380 K)	3410 K±0.5 %
ERTJ0EG103□M	10 kΩ	3380 K±1 %	3435 K±1 %
ERTJ0EP473□M	47 kΩ	4050 K±1 %	(4100 K)
ERTJ0ER104□M	100 kΩ	4250 K±1 %	(4300 K)
ERTJ0ET104□M	100 kΩ	4485 K±1 %	(4550 K)
ERTJ0EV104□M	100 kΩ	4700 K±1 %	(4750 K)
ERTJ0EV474□M	470 kΩ	4700 K±1 %	(4750 K)

□ : Resistance Tolerance Code (F : ±1%, G : ±2%, H : ±3%, J : ±5%)

### ● 0603(EIA)

Part Number	Nominal Resistance at 25 °C	B Value at 25/50(K)	B Value at 25/85(K)
ERTJ1VK102□M	1 kΩ	3650 K±1 %	(3690 K)
ERTJ1VG103□M	10 kΩ	3380 K±1 %	3435 K±1 %
ERTJ1VP473□M	47 kΩ	4100 K±1 %	(4150 K)
ERTJ1VR104□M	100 kΩ	4200 K±1 %	(4250 K)
ERTJ1VV104□M	100 kΩ	4700 K±1 %	(4750 K)
ERTJ1VT224□M	220 kΩ	4485 K±1 %	(4550 K)

□ : Resistance Tolerance Code (F : ±1%, G : ±2%, H : ±3%, J : ±5%)

### ● Temperature and Resistance value (the resistance value at 25 °C is set to 1)/ Reference values

	ERTJ□□G to	ERTJ1VK to	ERTJ0EP to	ERTJ1VP to	ERTJ0ER to	ERTJ1VR to	ERTJ□□T to	ERTJ□□V to
B <sub>25/50</sub>	(3380 K)	3650 K	4050 K	4100 K	4250 K	4200 K	4485 K	4700 K
B <sub>25/85</sub>	3435 K	(3690 K)	(4100 K)	(4150 K)	(4300 K)	(4250 K)	(4550 K)	(4750 K)
T(°C)								
-40	20.52	25.77	33.10	34.56	42.40	40.49	46.47	59.76
-35	15.48	19.10	24.03	24.99	29.96	28.81	32.92	41.10
-30	11.79	14.29	17.63	18.26	21.42	20.72	23.55	28.61
-25	9.069	10.79	13.06	13.48	15.50	15.07	17.00	20.14
-20	7.037	8.221	9.761	10.04	11.33	11.06	12.38	14.33
-15	5.507	6.312	7.362	7.546	8.370	8.198	9.091	10.31
-10	4.344	4.883	5.599	5.720	6.244	6.129	6.729	7.482
-5	3.453	3.808	4.291	4.369	4.699	4.622	5.019	5.481
0	2.764	2.993	3.312	3.362	3.565	3.515	3.772	4.050
5	2.227	2.372	2.574	2.604	2.725	2.694	2.854	3.015
10	1.806	1.892	2.013	2.030	2.098	2.080	2.173	2.262
15	1.474	1.520	1.584	1.593	1.627	1.618	1.666	1.710
20	1.211	1.229	1.255	1.258	1.271	1.267	1.286	1.303
25	1	1	1	1	1	1	1	1
30	0.8309	0.8185	0.8016	0.7994	0.7923	0.7944	0.7829	0.7734
35	0.6941	0.6738	0.6461	0.6426	0.6318	0.6350	0.6168	0.6023
40	0.5828	0.5576	0.5235	0.5194	0.5069	0.5108	0.4888	0.4721
45	0.4916	0.4639	0.4266	0.4222	0.4090	0.4132	0.3896	0.3723
50	0.4165	0.3879	0.3496	0.3451	0.3320	0.3363	0.3123	0.2954
55	0.3543	0.3258	0.2881	0.2837	0.2709	0.2752	0.2516	0.2356
60	0.3027	0.2749	0.2386	0.2344	0.2222	0.2263	0.2037	0.1889
65	0.2595	0.2330	0.1985	0.1946	0.1831	0.1871	0.1658	0.1523
70	0.2233	0.1984	0.1659	0.1623	0.1516	0.1554	0.1357	0.1236
75	0.1929	0.1696	0.1393	0.1359	0.1261	0.1297	0.1117	0.1009
80	0.1672	0.1456	0.1174	0.1143	0.1054	0.1087	0.09236	0.08284
85	0.1451	0.1255	0.09937	0.09658	0.08843	0.09153	0.07675	0.06834
90	0.1261	0.1087	0.08442	0.08189	0.07457	0.07738	0.06404	0.05662
95	0.1097	0.09440	0.07200	0.06969	0.06316	0.06567	0.05366	0.04712
100	0.09563	0.08229	0.06166	0.05957	0.05371	0.05596	0.04518	0.03939
105	0.08357	0.07195	0.05306	0.05117	0.04585	0.04786	0.03825	0.03308
110	0.07317	0.06311	0.04587	0.04415	0.03929	0.04108	0.03255	0.02791
115	0.06421	0.05552	0.03979	0.03823	0.03378	0.03539	0.02781	0.02364
120	0.05650	0.04899	0.03460	0.03319	0.02913	0.03059	0.02382	0.02009
125	0.04986	0.04336	0.03013	0.02886	0.02519	0.02652	0.02043	0.01712
130	0.04413	0.03849	0.02629	0.02513	0.02184	0.02307	0.01755	0.01464
135	0.03916	0.03426	0.02298	0.02193	0.01898	0.02013	0.01511	0.01256
140	0.03483	0.03058	0.02013	0.01918	0.01654	0.01762	0.01304	0.01080
145	0.03105	0.02736	0.01767	0.01680	0.01445	0.01546	0.01127	0.00931
150	0.02774	0.02454	0.01553	0.01476	0.01265	0.01361	0.00976	0.00806

$$B_{25/50} = \frac{\ln(R_{25}/R_{50})}{1/298.15 - 1/323.15}$$

$$B_{25/85} = \frac{\ln(R_{25}/R_{85})}{1/298.15 - 1/358.15}$$

R<sub>25</sub>=Resistance at 25.0±0.1 °C  
 R<sub>50</sub>=Resistance at 50.0±0.1 °C  
 R<sub>85</sub>=Resistance at 85.0±0.1 °C

## Specification and Test Method

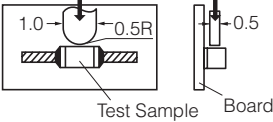
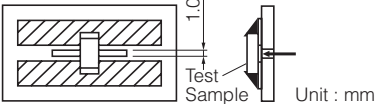
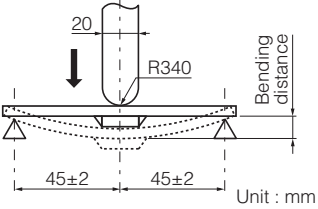
Item	Specification	Test Method									
Rated Zero-power Resistance (R <sub>25</sub> )	Within the specified tolerance.	The value is measured at a power that the influence of self-heat generation can be negligible (0.1mW or less), at the rated ambient temperature of 25.0±0.1°C.									
B Value	Shown in each Individual Specification. * Individual Specification shall specify B <sub>25/50</sub> or B <sub>25/85</sub> .	<p>The Zero-power resistances; R<sub>1</sub> and R<sub>2</sub>, shall be measured respectively at T<sub>1</sub> (deg.C) and T<sub>2</sub> (deg.C). The B value is calculated by the following equation.</p> $B_{T_1/T_2} = \frac{\ln(R_1) - \ln(R_2)}{1/(T_1 + 273.15) - 1/(T_2 + 273.15)}$ <table border="1"> <thead> <tr> <th></th> <th>T<sub>1</sub></th> <th>T<sub>2</sub></th> </tr> </thead> <tbody> <tr> <td>B<sub>25/50</sub></td> <td>25.0 ±0.1 °C</td> <td>50.0 ±0.1 °C</td> </tr> <tr> <td>B<sub>25/85</sub></td> <td>25.0 ±0.1 °C</td> <td>85.0 ±0.1 °C</td> </tr> </tbody> </table>		T <sub>1</sub>	T <sub>2</sub>	B <sub>25/50</sub>	25.0 ±0.1 °C	50.0 ±0.1 °C	B <sub>25/85</sub>	25.0 ±0.1 °C	85.0 ±0.1 °C
	T <sub>1</sub>	T <sub>2</sub>									
B <sub>25/50</sub>	25.0 ±0.1 °C	50.0 ±0.1 °C									
B <sub>25/85</sub>	25.0 ±0.1 °C	85.0 ±0.1 °C									
Adhesion	The terminal electrode shall be free from peeling or signs of peeling.	<p>Applied force : Size 0402, 0603 : 5 N Duration : 10 s</p> <p>Size : 0402</p>  <p>Size : 0603</p>  <p>Unit : mm</p>									
Bending Strength	There shall be no cracks and other mechanical damage. R <sub>25</sub> change : within ±5 %	<p>Bending distance : 2 mm Bending speed : 1 mm/s</p>  <p>Unit : mm</p>									
Resistance to Vibration	There shall be no cracks and other mechanical damage. R <sub>25</sub> change : within ±2 % B Value change : within ±1 %	<p>Solder samples on a testing substrate, then apply vibration to them.</p> <p>Acceleration : 5 G Vibrational frequency : 10 to 2000 Hz Sweep time : 20 minutes 12 cycles in three directions, which are perpendicular to each other</p>									
Resistance to Impact	There shall be no cracks and other mechanical damage. R <sub>25</sub> change : within ±2 % B Value change : within ±1 %	<p>Solder samples on a testing substrate, then apply impacts to them.</p> <p>Pulse waveform : Semisinusoidal wave, 11 ms Impact acceleration : 50 G Impact direction : X-X', Y-Y', Z-Z' In 6 directions, three times each</p>									



## Specification and Test Method

Item	Specification	Test Method									
Resistance to Soldering Heat	There shall be no cracks and other mechanical damage.  R <sub>25</sub> change : within ±2 % B Value change : within ±1 %	Soldering bath method Solder temperature : 260 ±5 °C, 270 ±5 °C Dipping period : 3.0 ±0.5 s, 10.0 ±0.5 s Preheat condition : <table border="1"> <thead> <tr> <th>Step</th> <th>Temp (°C)</th> <th>Period (s)</th> </tr> </thead> <tbody> <tr> <td>1</td> <td>80 to 100</td> <td>120 to 180</td> </tr> <tr> <td>2</td> <td>150 to 200</td> <td>120 to 180</td> </tr> </tbody> </table>	Step	Temp (°C)	Period (s)	1	80 to 100	120 to 180	2	150 to 200	120 to 180
Step	Temp (°C)	Period (s)									
1	80 to 100	120 to 180									
2	150 to 200	120 to 180									
Solderability	More than 95 % of the soldered area of both terminal electrodes shall be covered with fresh solder.	Soldering bath method Solder temperature : 230 ±5 °C Dipping period : 4 ±1 s Solder : Sn-3.0Ag-0.5Cu									
Temperature Cycling	R <sub>25</sub> change : within ±2 % B Value change : within ±1 %	Conditions of one cycle Step 1 : -55±3 °C, 30±3 min. Step 2 : Room temp., 3 min. max. Step 3 : 125±5 °C, 30±3 min. Step 4 : Room temp., 3 min. max. Number of cycles: 2000 cycles									
Humidity	R <sub>25</sub> change : within ±2 % B Value change : within ±1 %	Temperature : 85 ±2 °C Relative humidity : 85 ±5 % Test period : 2000 +48/0 h									
Biased Humidity	R <sub>25</sub> change : within ±2 % B Value change : within ±1 %	Temperature : 85 ±2 °C Relative humidity : 85 ±5 % Applied power : 10 mW(D.C.) Test period : 2000 +48/0 h									
Low Temperature Exposure	R <sub>25</sub> change : within ±2 % B Value change : within ±1 %	Temperature : -40 ±3 °C Test period : 2000 +48/0 h									
High Temperature Exposure 1	R <sub>25</sub> change : within ±2 % B Value change : within ±1 %	Temperature : 125 ±3 °C Test period : 2000 +48/0 h									
High Temperature Exposure 2	R <sub>25</sub> change : within ±3 % B Value change : within ±2 %	Temperature : 150 ±3 °C Test period : 1000 +48/0 h									

## Dimensions in mm (not to scale)



(Unit: mm)

Size Code (EIA)	L	W	T	L <sub>1</sub> , L <sub>2</sub>
0 (0402)	1.0±0.1	0.50±0.05	0.50±0.05	0.25±0.15
1 (0603)	1.60±0.15	0.8±0.1	0.8±0.1	0.3±0.2

## Packaging Methods

### Standard Packing Quantities

Size Code	Thickness (mm)	Kind of Taping	Pitch (mm)	Quantity (pcs./reel)
0 (0402)	0.5	Punched Carrier Taping	2	10,000
1 (0603)	0.8		4	4,000

### Reel for Taping

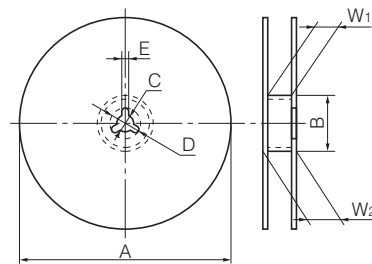

Symbol	φA	φB	C	D	E	W <sub>1</sub>	W <sub>2</sub>
Dim. (mm)	180 <sup>-0.3</sup>	60.0 <sup>+1.0</sup> <sub>0</sub>	13.0±0.5	21.0±0.8	2.0±0.5	9.0 <sup>+1.0</sup> <sub>0</sub>	11.4±1.0

### Pitch 2 mm (Punched Carrier Taping) : Size 0402

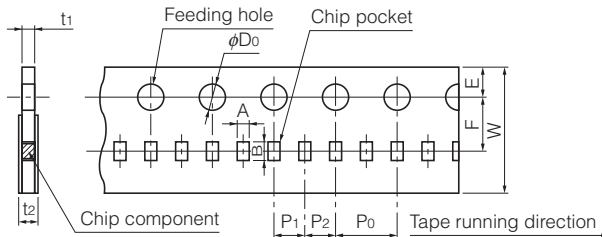

Symbol	A	B	W	F	E	P <sub>1</sub>	P <sub>2</sub>	P <sub>0</sub>	φD <sub>0</sub>	t <sub>1</sub>	t <sub>2</sub>
Dim. (mm)	0.62 ±0.05	1.12 ±0.05	8.0 ±0.2	3.50 ±0.05	1.75 ±0.10	2.00 ±0.05	2.00 ±0.05	4.0 ±0.1	1.5 <sup>+0.1</sup> <sub>0</sub>	0.7 max.	1.0 max.

### Pitch 4 mm (Punched Carrier Taping) : Size 0603

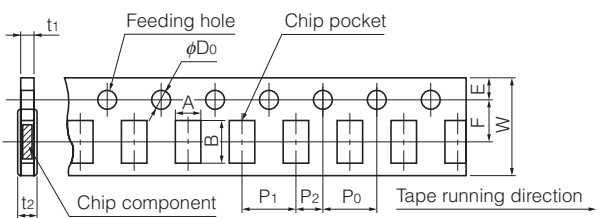

Symbol	A	B	W	F	E	P <sub>1</sub>	P <sub>2</sub>	P <sub>0</sub>	φD <sub>0</sub>	t <sub>1</sub>	t <sub>2</sub>
Dim. (mm)	1.0 ±0.1	1.8 ±0.1	8.0 ±0.2	3.50 ±0.05	1.75 ±0.10	4.0 ±0.1	2.00 ±0.05	4.0 ±0.1	1.5 <sup>+0.1</sup> <sub>0</sub>	1.1 max.	1.4 max.

### Leader Part and Taped End

#### Leader part



#### Taped end



(Unit : mm)

## Minimum Quantity / Packing Unit

Part Number (Size)	Minimum Quantity/ Packing Unit	Packing Quantity in Carton	Carton L×W×H (mm)
ERTJ0 (0402)	10,000	200,000	250×200×200
ERTJ1 (0603)	4,000	80,000	250×200×200

Part No., quantity and country of origin are designated on outer packages in English.

# Multilayer NTC Thermistors (Automotive Grade)

Series: ERTJ

## Handling Precautions

### [Precautions]

- **Do not use the products beyond the descriptions in this product catalog.**
- **This product catalog guarantees the quality of the products as individual components. Before you use the products, please make sure to check and evaluate the products in the circumstance where they are installed in your product.**

### Safety Precautions

Multilayer NTC Thermistors for Automotive Grade (hereafter referred to as “Thermistors”) are intended to be used in general-purpose applications as measures against Temperature detection and Temperature compensation in automotive Grade equipment.

When subjected to severe electrical, environmental, and/or mechanical stress beyond the specifications, as noted in the Ratings and Specified Conditions section, the Thermistors’ performance may be degraded, or become failure mode, such as short circuit mode and open-circuit mode.

If you use under the condition of short-circuit, heat generation of Thermistors will occur by running large current due to application of voltage. There are possibilities of smoke emission, substrate burn-out, and, in the worst case, fire. For products which require high safety levels, please carefully consider how a single malfunction can affect your product. In order to ensure the safety in the case of a single malfunction, please design products with fail-safe, such as setting up protecting circuits, etc.

We are trying to improve the quality and the reliability, but the durability differs depending on the use environment and the use conditions. On use, be sure to confirm the actual product under the actual use conditions.

- For the following applications and conditions, please be sure to consult with our sales representative in advance and to exchange product specifications which conform to such applications.
    - When your application may have difficulty complying with the safety or handling precautions specified below.
    - High-quality and high-reliability required devices that have possibility of causing hazardous conditions, such as death or injury (regardless of directly or indirectly), due to failure or malfunction of the product.
- ① Aircraft and Aerospace Equipment (artificial satellite, rocket, etc.)
  - ② Submarine Equipment (submarine repeating equipment, etc.)
  - ③ Transportation Equipment (airplanes, trains, ship, traffic signal controllers, etc.)
  - ④ Power Generation Control Equipment  
(atomic power, hydroelectric power, thermal power plant control system, etc.)
  - ⑤ Medical Equipment (life-support equipment, pacemakers, dialysis controllers, etc.)
  - ⑥ Information Processing Equipment (large scale computer systems, etc.)
  - ⑦ Electric Heating Appliances, Combustion devices (gas fan heaters, oil fan heaters, etc.)
  - ⑧ Rotary Motion Equipment
  - ⑨ Security Systems
  - ⑩ And any similar types of equipment

### Strict Observance

#### 1. Confirmation of Rated Performance

The Thermistors shall be operated within the specified rating/performance.

Applications exceeding the specifications may cause deteriorated performance and/or breakdown, resulting in degradation and/or smoking or ignition of products. The following are strictly observed.

- (1) The Thermistors shall not be operated beyond the specified operating temperature range.
- (2) The Thermistors shall not be operated in excess of the specified maximum power dissipation.

#### 2. The Thermistors shall not be mounted near flammables.

## Operating Conditions and Circuit Design

### 1. Circuit Design

#### 1.1 Operating Temperature and Storage Temperature

When operating a components-mounted circuit, please be sure to observe the "Operating Temperature Range", written in delivery specifications. Storage temperature of PCB after mounting Thermistors, which is not operated, should be within the specified "Storage Temperature Range" in the delivery specifications. Please remember not to use the product under the condition that exceeds the specified maximum temperature.

#### 1.2 Operating Power

The electricity applied to between terminals of Thermistors should be under the specified maximum power dissipation. There are possibilities of breakage and burn-out due to excessive self-heating of Thermistors, if the power exceeds maximum power dissipation when operating. Please consider installing protection circuit for your circuit to improve the safety, in case of abnormal voltage application and so on. Thermistors' performance of temperature detection would be deteriorated if self-heating occurs, even when you use it under the maximum power dissipation. Please consider the maximum power dissipation and dissipation factor.

#### 【Maximum power dissipation】

- The Maximum power that can be continuously applied under static air at a certain ambient temperature. The Maximum power dissipation under an ambient temperature of 25 °C or less is the same with the rated maximum power dissipation, and Maximum power dissipation beyond 25 °C depends on the Decreased power dissipation curve below.

#### 【Dissipation factor】

- The constant amount power required to raise the temperature of the Thermistor 1 °C through self heat generation under stable temperatures.  
Dissipation factor (mW/°C) = Power consumption of Thermistor / Temperature rise of element.



#### 1.3 Environmental Restrictions

The Thermistors does not take the use under the following special environments into consideration. Accordingly, the use in the following special environments, and such environmental conditions may affect the performance of the product; prior to use, verify the performance, reliability, etc. thoroughly.

- ① Use in liquids such as water, oil, chemical, and organic solvent.
- ② Use under direct sunlight, in outdoor or in dusty atmospheres.
- ③ Use in places full of corrosive gases such as sea breeze, Cl<sub>2</sub>, H<sub>2</sub>S, NH<sub>3</sub>, SO<sub>2</sub>, and NOx.
- ④ Use in environment with large static electricity or strong electromagnetic waves or strong radial ray.
- ⑤ Where the product is close to a heating component, or where an inflammable such as a polyvinyl chloride wire is arranged close to the product.
- ⑥ Where this product is sealed or coated with resin etc.
- ⑦ Where solvent, water, or water-soluble detergent is used in flux cleaning after soldering.  
(Pay particular attention to water-soluble flux.)
- ⑧ Use in such a place where the product is wetted due to dew condensation.
- ⑨ Use the product in a contaminated state.  
Ex.) Do not handle the product such as sticking sebum directly by touching the product after mounting printed circuit board.
- ⑩ Under severe conditions of vibration or impact beyond the specified conditions found in the Specifications.

#### 1.4 Measurement of Resistance

The resistance of the Thermistors varies depending on ambient temperatures and self-heating. To measure the resistance value when examining circuit configuration and conducting receiving inspection and so on, the following points should be taken into consideration:

- ① Measurement temp : 25±0.1 °C  
Measurement in liquid (silicon oil, etc.) is recommended for a stable measurement temperature.
- ② Power : 0.10 mW max. 4 terminal measurement with a constant-current power supply is recommended.

## 2. Design of Printed Circuit Board

### 2.1 Selection of Printed Circuit Boards

There is a possibility of performance deterioration by heat shock (temperature cycles), which causes cracks, from alumina substrate. Please confirm that the substrate you use does not deteriorate the Thermistors' quality.

### 2.2 Design of Land Pattern

(1) Recommended land dimensions are shown below. Use the proper amount of solder in order to prevent cracking. Using too much solder places excessive stress on the Thermistors..

Recommended Land Dimensions(Ex.)



Size Code/EIA	Component dimensions			Unit (mm)		
	L	W	T	a	b	c
0(0402)	1.0	0.5	0.5	0.4 to 0.5	0.4 to 0.5	0.4 to 0.5
1(0603)	1.6	0.8	0.8	0.8 to 1.0	0.6 to 0.8	0.6 to 0.8

(2) The land size shall be designed to have equal space, on both right and left side. If the amount of solder on both sides is not equal, the component may be cracked by stress since the side with a larger amount of solder solidifies later during cooling.

### Recommended Amount of Solder

(a) Excessive amount    (b) Proper amount    (c) Insufficient amount

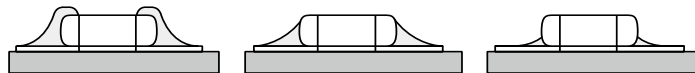

### 2.3 Utilization of Solder Resist

(1) Solder resist shall be utilized to equalize the amounts of solder on both sides.

(2) Solder resist shall be used to divide the pattern for the following cases;

- Components are arranged closely.
- The Thermistor is mounted near a component with lead wires.
- The Thermistor is placed near a chassis.

Refer to the table below.

### Prohibited Applications and Recommended Applications

Item	Prohibited applications	Improved applications by pattern division
Mixed mounting with a component with lead wires	The lead wire of a Component With lead wires 	Solder resist 
Arrangement near chassis	Chassis Solder(ground solder) Electrode pattern 	Solder resist 
Retro-fitting of component with lead wires	A lead wire of Retrofitted component Soldering iron iron 	Solder resist 
Lateral arrangement	Portion to be Excessively soldered Land 	Solder resist 

### 2.4 Component Layout

To prevent the crack of Thermistors, try to place it place it on the position that could not easily be affected by the bending stress of substrate while mounting procedures or procedures afterwards. Placement of the Thermistors near heating elements also requires the great care to be taken in order to avoid stresses from rapid heating and cooling.

- (1) To minimize mechanical stress caused by the warp or bending of a PC board, please follow the recommended Thermistors' layout below.



- (2) The following layout is for your reference since mechanical stress near the dividing/breaking position of a PC board varies depending on the mounting position of the Thermistors.



- (3) The magnitude of mechanical stress applied to the Thermistors when dividing the circuit board in descending order is as follows: push back < slit < V-groove < perforation. Also take into account the layout of the Thermistors and the dividing/breaking method.
- (4) When the Thermistors are placed near heating elements such as heater, etc., cracks from thermal stresses may occur under following situation:
- Soldering the Thermistors directly to heating elements.
  - Sharing the land with heating elements.
- If planning to conduct above-mentioned mounting and/or placement, please contact us in advance.

## 2.5 Mounting Density and Spaces

Intervals between components should not be too narrow to prevent the influence from solder bridges and solder balls. The space between components should be carefully determined.

## Precautions for Assembly

### 1. Storage

- (1) The Thermistors shall be stored between 5 to 40 °C and 20 to 70 % RH, not under severe conditions of high temperature and humidity.
- (2) If stored in a place where humidity, dust, or corrosive gasses (hydrogen sulfide, sulfurous acid, hydrogen chloride and ammonia, etc.) are contained, the solderability of terminals electrodes will be deteriorated. In addition, storage in a place where the heat or direct sunlight exposure occurs will causes or direct sunlight exposure occurs will causes mounting problems due to deformation of tapes and reels and components and taping/reels sticking together.
- (3) Do not store components longer than 6 months. Check the solderability of products that have been stored for more than 6 months before use.

### 2. Chip Mounting Consideration

- (1) When mounting the Thermistors/components on a PC board, the Thermistor bodies shall be free from excessive impact loads such as mechanical impact or stress due to the positioning, pushing force and displacement of vacuum nozzles during mounting.
- (2) Maintenance and inspection of the Chip Mounter must be performed regularly.
- (3) If the bottom dead center of the vacuum nozzle is too low, the Thermistor will crack from excessive force during mounting. The following precautions and recommendations are for your reference in use.
  - (a) Set and adjust the bottom dead center of the vacuum nozzles to the upper surface of the PC board after correcting the warp of the PC board.
  - (b) Set the pushing force of the vacuum nozzle during mounting to 1 to 3 N in static load.
  - (c) For double surface mounting, apply a supporting pin on the rear surface of the PC board to suppress the bending of the PC board in order to minimize the impact of the vacuum nozzles. Typical examples are shown in the table below.
  - (d) Adjust the vacuum nozzles so that their bottom dead center during mounting is not too low.



Item	Prohibited mounting	Recommended mounting
Single surface mounting	 Crack	 Supporting pin The supporting pin does not necessarily have to be positioned
Double surface mounting	 Separation of solder Crack	 Supporting pin

- (4) The closing dimensions of the positioning chucks shall be controlled. Maintenance and replacement of positioning chucks shall be performed regularly to prevent chipping or cracking of the Thermistors caused by mechanical impact during positioning due to worn positioning chucks.
- (5) Maximum stroke of the nozzle shall be adjusted so that the maximum bending of PC board does not exceed 0.5 mm at 90 mm span. The PC board shall be supported by an adequate number of supporting pins.

### 3. Selection of Soldering Flux

Soldering flux may seriously affect the performance of the Thermistors. The following shall be confirmed before use.

- (1) The soldering flux should have a halogen based content of 0.1 wt% (converted to chlorine) or below. Do not use soldering flux with strong acid.
- (2) When applying water-soluble soldering flux, wash the Thermistors sufficiently because the soldering flux residue on the surface of PC boards may deteriorate the insulation resistance on the Thermistors' surface.

### 4. Soldering

#### 4.1 Reflow Soldering

The reflow soldering temperature conditions are composed of temperature curves of Preheating, Temp. rise, Heating, Peak and Gradual cooling. Large temperature difference inside the Thermistors caused by rapid heat application to the Thermistors may lead to excessive thermal stresses, contributing to the thermal cracks. The Preheating temperature requires controlling with great care so that tombstone phenomenon may be prevented.

Recommended profile of Reflow Soldering (Ex.)



Item	Temperature	Period or Speed
① Preheating	140 to 180 °C	60 to 120 s
② Temp. rise	Preheating temp to Peak temp.	2 to 5 °C / s
③ Heating	220 °C min.	60 s max.
④ Peak	260 °C max.	10 s max.
⑤ Gradual cooling	Peak temp. to 140 °C	1 to 4 °C / s

$\Delta T$  : Allowable temperature difference  $\Delta T \leq 150$  °C

The rapid cooling (forced cooling) during Gradual cooling part should be avoided, because this may cause defects such as the thermal cracks, etc. When the Thermistors are immersed into a cleaning solvent, make sure that the surface temperatures of the devices do not exceed 100 °C. Performing reflow soldering twice under the conditions shown in the figure above [Recommended profile of Flow soldering (Ex.)] will not cause any problems. However, pay attention to the possible warp and bending of the PC board.

Recommended soldering condition is for the guideline for ensuring the basic characteristics of the components, not for the stable soldering conditions. Conditions for proper soldering should be set up according to individual conditions. The temperature of this product at the time of mounting changes depending on mounting conditions, therefore, please confirm that Product surface becomes the specified temperature when mounting it on the end product.

## 4.2 Hand Soldering

Hand soldering typically causes significant temperature change, which may induce excessive thermal stresses inside the Thermistors, resulting in the thermal cracks, etc. In order to prevent any defects, the following should be observed.

- The temperature of the soldering tips should be controlled with special care.
- The direct contact of soldering tips with the Thermistors and/or terminal electrodes should be avoided.
- Dismounted Thermistors shall not be reused.

### (1) Condition 1 (with preheating)

- Soldering : Use thread solder ( $\phi$  1.0 mm or below) which contains flux with low chlorine, developed for precision electronic equipment.
- Preheating : Conduct sufficient pre-heating, and make sure that the temperature difference between solder and Thermistors' surface is 150 °C or less.
- Temperature of Iron tip: 300 °C max.  
(The required amount of solder shall be melted in advance on the soldering tip.)
- Gradual cooling : After soldering, the Thermistors shall be cooled gradually at room temperature.

Recommended profile of Hand soldering (Ex.)

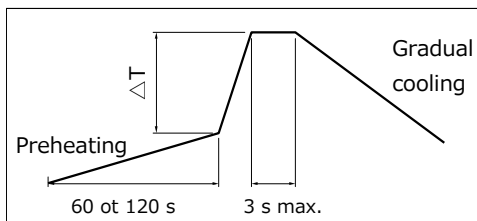

$\Delta T$  : Allowable temperature difference  $\Delta T \leq 150$  °C

### (2) Condition 2 (without preheating)

Hand soldering can be performed without preheating, by following the conditions below:

- Soldering iron tip shall never directly touch the ceramic and terminal electrodes of the Thermistors.
- The lands are sufficiently preheated with a soldering iron tip before sliding the soldering iron tip to the terminal electrodes of the Thermistors for soldering.

Conditions of Hand soldering without preheating

Item	Condition
Temperature of Iron tip	270 °C max.
Wattage	20 W max.
Shape of Iron tip	$\phi$ 3 mm max.
Soldering time with a soldering iron	3 s max.

## 5. Post Soldering Cleaning

### 5.1 Cleaning solvent

Soldering flux residue may remain on the PC board if cleaned with an inappropriate solvent. This may deteriorate the electrical characteristics and reliability of the Thermistors.

### 5.2 Cleaning conditions

Inappropriate cleaning conditions such as insufficient cleaning or excessive cleaning may impair the electrical characteristics and reliability of the Thermistors.

#### (1) Insufficient cleaning can lead to :

- The halogen substance found in the residue of the soldering flux may cause the metal of terminal electrodes to corrode.
- The halogen substance found in the residue of the soldering flux on the surface of the Thermistors may change resistance values.
- Water-soluble soldering flux may have more remarkable tendencies of (a) and (b) above compared to those of rosin soldering flux.

#### (2) Excessive cleaning can lead to :

- When using ultrasonic cleaner, make sure that the output is not too large, so that the substrate will not resonate. The resonance causes the cracks in Thermistors and/or solders, and deteriorates the strength of the terminal electrodes. Please follow these conditions for Ultrasonic cleaning:  
Ultrasonic wave output : 20 W/L max.  
Ultrasonic wave frequency : 40 kHz max.  
Ultrasonic wave cleaning time : 5 min. max.

**5.3 Contamination of Cleaning solvent**

Cleaning with contaminated cleaning solvent may cause the same results as that of insufficient cleaning due to the high density of liberated halogen.

**6. Inspection Process**

The pressure from measuring terminal pins might bend the PCB when implementing circuit inspection after mounting Thermistors on PCB, and as a result, cracking may occur.

- (1) Mounted PC boards shall be supported by an adequate number of supporting pins on the back with bend settings of 90 mm span 0.5 mm max.
- (2) Confirm that the measuring pins have the right tip shape, are equal in height, have the right pressure and are set in the correct positions. The following figures are for your reference to avoid bending the PC board.

Item	Prohibited mounting	Recommended mounting
Bending of PC board	 <p>Separated, Crack</p>	 <p>Supporting pin</p>

**7. Protective Coating**

Make sure characteristics and reliability when using the resin coating or resin embedding for the purpose of improvement of humidity resistance or gas resistance, or fixing of parts because failures of a thermistors such as 1) ,2) and 3) may be occurred.

- (1) The solvent which contained in the resin permeate into the Thermistors, and it may deteriorate the characteristic.
- (2) When hardening the resin, chemical reaction heat (curing heat generation) happen and it may occurs the infection to the Thermistors.
- (3) The lead wire might be cut down and the soldering crack might be happen by expansion or contraction of resin hardening.

**8. Dividing/Breaking of PC Boards**

- (1) Please be careful not to stress the substrate with bending/twisting when dividing, after mounting components including Thermistors. Abnormal and excessive mechanical stress such as bending or torsion shown below can cause cracking in the Thermistors.



- (2) Dividing/Breaking of the PC boards shall be done carefully at moderate speed by using a jig or apparatus to prevent the Thermistors on the boards from mechanical damage.
- (3) Examples of PCB dividing/breaking jigs: The outline of PC board breaking jig is shown below. When PC board are broken or divided, loading points should be close to the jig to minimize the extent of the bending. Also, planes with no parts mounted on should be used as plane of loading, in order to prevent tensile stress induced by the bending, which may cause cracks of the Thermistors or other parts mounted on the PC boards.



## 10. Mechanical Impact

- (1) The Thermistors shall be free from any excessive mechanical impact.

The Thermistor body is made of ceramics and may be damaged or cracked if dropped. Never use a Thermistor which has been dropped; their quality may already be impaired, and in that case, failure rate will increase.

- (2) When handling PC boards with Thermistors mounted on them, do not allow the Thermistors to collide with another PC board.

When mounted PC boards are handled or stored in a stacked state, the corner of a PC board might strike Thermistors, and the impact of the strike may cause damage or cracking and can deteriorate the withstand voltage and insulation resistance of the Thermistors.



- 11.** Do not reuse this product after removal from the mounting board.

## Precautions for discarding

As to the disposal of the Thermistors, check the method of disposal in each country or region where the modules are incorporated in your products to be used.

## Other

The Thermistors precautions described above are typical. For special mounting conditions, please contact us. The technical information in this catalog provides example of our products' typical operations and application circuit.

## Applicable laws and regulations , others

1. This product not been manufactured with any ozone depleting chemical controlled under the Montreal Protocol.
2. This product comply with RoHS(Restriction of the use of certain Hazardous Substance in electrical and electronic equipment) (DIRECTIVE 2011/65/EU and 2015/863/EU).
3. All the materials used in this part are registered material under the Law Concerning the Examination and Regulation of Manufacture, etc. of Chemical Substance.
4. If you need the notice by letter of "A preliminary judgement on the Laws of Japan foreign exchange and Foreign Trade Control", be sure to let us know.
5. These products are not dangerous goods on the transportation as identified by UN (United nations) numbers or UN classification.
6. The technical information in this catalog provides example of our products' typical operations and application circuit. We do not guarantee the non-infringement of third party's intellectual property rights and we do not grant any license, Right or interest in our intellectual property.

## AEC-Q200 Compliant

The products are tested based on all or part of the test conditions and methods defined in AEC-Q200. Please consult with Panasonic for the details of the product specification and specific evaluation test results, etc., and please review and approve Panasonic's product specification before ordering.

## “PGS” Graphite Sheets

Type: EYG

“PGS (Pyrolytic Graphite Sheet)” is a thermal interface which is very thin, synthetically made, has high thermal conductivity, and is made from a highly oriented graphite polymer film. It is ideal for providing thermal management/heat-sinking in limited spaces or to provide supplemental heat-sinking in addition to conventional means.

This material is flexible and can be cut into customizable shapes. SSM(Semi-Sealing Material) is the product which is compounding PGS Graphite sheet and High thermal conductive Elastomer resin. It has a function to absorb heat by resin and release the heat by utilizing high thermal conductivity of PGS Graphite sheet. It also enables taking better attachment to the component which has different height on the electronic board, reducing stress to the electronic board.

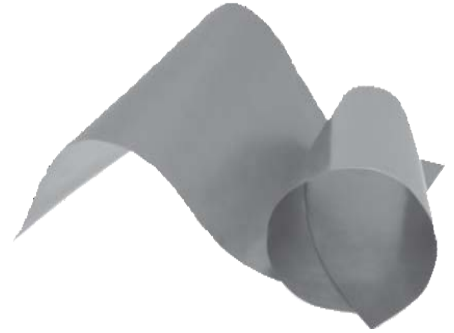

### Features

- Excellent thermal conductivity : 700 to 1950 W/(m·K)  
(2 to 5 times as high as copper, 3 to 8 times as high as aluminum)
- Lightweight: Specific gravity : 0.85 to 2.13 g/cm<sup>3</sup>  
(1/4 to 1/10 of copper, 1/1.3 to 1/3 of aluminum in density)
- Flexible and easy to be cut or trimmed. (withstands repeated bending)
- Low thermal resistance
- Low heat resistance with flexible Graphite sheet (SSM)
- Low repulsion and easy to keep the product's shape after attaching (SSM)
- Siloxane Free (SSM)
- High dielectric voltage : 17 kVac/mm (SSM)
- RoHS compliant

### Recommended applications

- Smart phones, Mobile phones, DSC, DVC, Tablet PCs, PCs and peripherals, LED Devices
- Semiconductor manufacturing equipment (Sputtering, Dry etching, Steppers)
- Optical communications equipment

### Explanation of Part Numbers

- PGS only (EYGS\*\*\*\*\*)

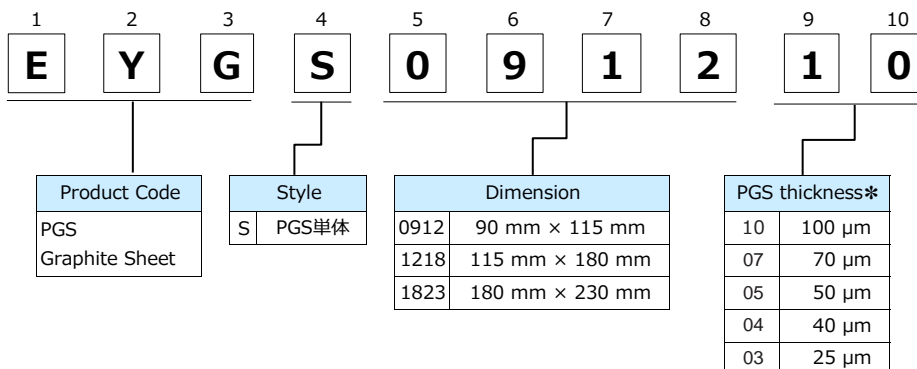

\*PGS thickness of 17 μm, 10 μm does not than those above.

**Explanation of Part Numbers**

● Taping (EYGA\*\*\*\*\*)\*\*

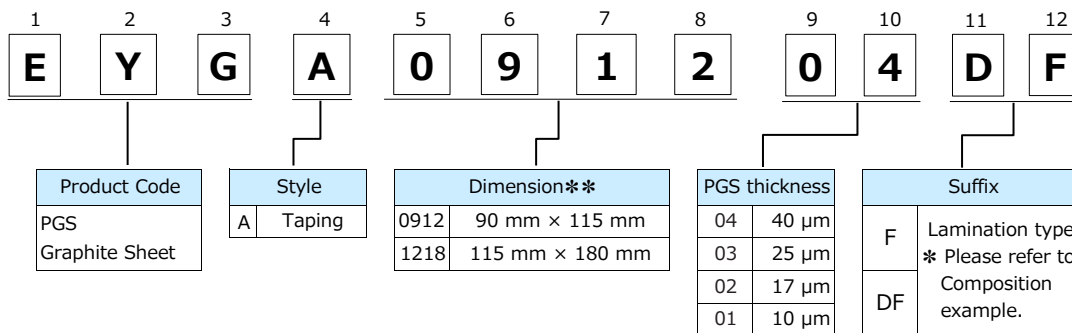
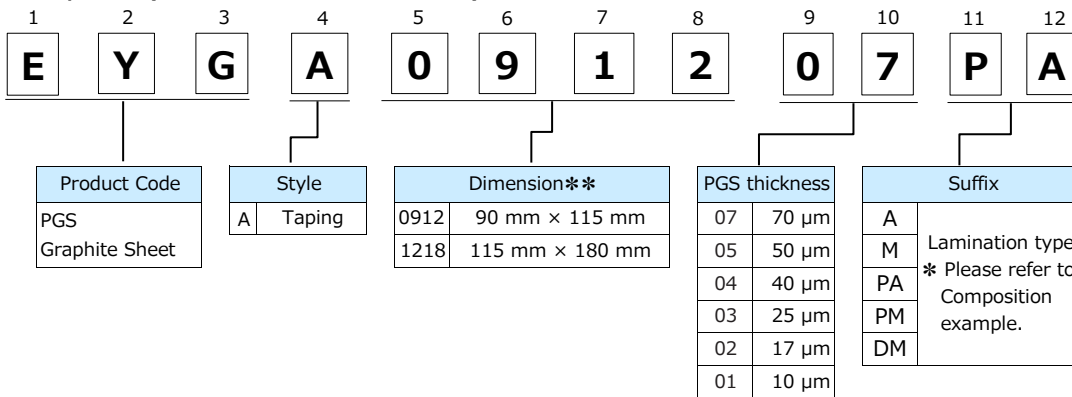

\*\* Please contact us for other dimensions other than those above.

● Thermally conductive elastomer processing (EYGE\*\*\*\*\*)\*\*

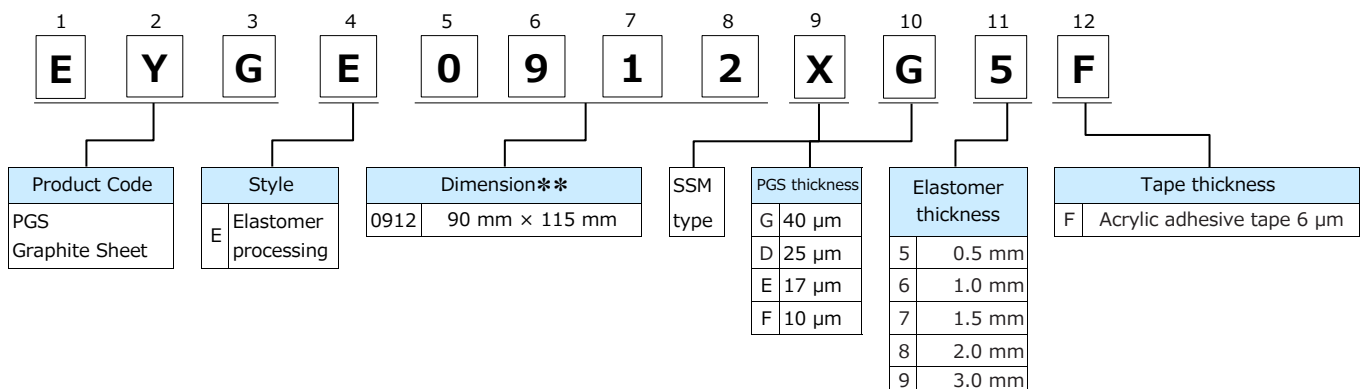
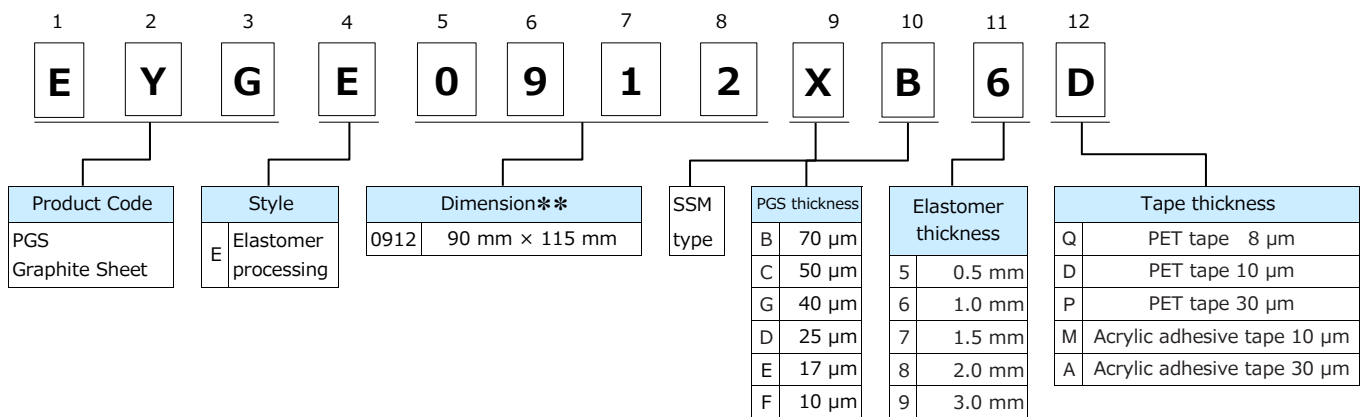

\*\* Please contact us for other dimensions other than those above.



## Characteristics of PGS Graphite Sheets

Thickness		100 μm	70 μm	50 μm	40 μm
		0.10±0.03 mm	0.07±0.015 mm	0.050±0.015 mm	0.040±0.012 mm
Density		0.85 g/cm <sup>3</sup>	1.21 g/cm <sup>3</sup>	1.70 g/cm <sup>3</sup>	1.80 g/cm <sup>3</sup>
Thermal conductivity	a-b plane	700 W/(m·K)	1000 W/(m·K)	1300 W/(m·K)	1350 W/(m·K)
Electrical conductivity		10000 S/cm	10000 S/cm	10000 S/cm	10000 S/cm
Extensional strength		20.0 MPa	20.0 MPa	20.0 MPa	25.0 MPa
Expansion coefficient	a-b plane	9.3×10 <sup>-7</sup> 1/K	9.3×10 <sup>-7</sup> 1/K	9.3×10 <sup>-7</sup> 1/K	9.3×10 <sup>-7</sup> 1/K
	c axis	3.2×10 <sup>-5</sup> 1/K	3.2×10 <sup>-5</sup> 1/K	3.2×10 <sup>-5</sup> 1/K	3.2×10 <sup>-5</sup> 1/K
Heat resistance*		400 °C			
Bending(angle 180,R5)		10000 cycles			

Thickness		25 μm	17 μm	10 μm
		0.025±0.010 mm	0.017±0.005 mm	0.010±0.002 mm
Density		1.90 g/cm <sup>3</sup>	2.10 g/cm <sup>3</sup>	2.13 g/cm <sup>3</sup>
Thermal conductivity	a-b plane	1600 W/(m·K)	1850 W/(m·K)	1950 W/(m·K)
Electrical conductivity		20000 S/cm	20000 S/cm	20000 S/cm
Extensional strength		30.0 MPa	40.0 MPa	40.0 MPa
Expansion coefficient	a-b plane	9.3×10 <sup>-7</sup> 1/K	9.3×10 <sup>-7</sup> 1/K	9.3×10 <sup>-7</sup> 1/K
	c axis	3.2×10 <sup>-5</sup> 1/K	3.2×10 <sup>-5</sup> 1/K	3.2×10 <sup>-5</sup> 1/K
Heat resistance*		400 °C		
Bending(angle 180,R5)		10000 cycles		

\* Withstand temperature refers to PGS only. (Lamination material such as PET tape etc. is not included)

\*\* Values are for reference, not guaranteed.

## Characteristics of SSM (Elastomer)

Thickness		1 mm	2 mm	3 mm
Specific heat		1.4 J/(g·C)		
Density		1.88 g/cm <sup>3</sup>		
Thermal conductivity		1.6 W/(m·K)**		
Thermal resistance	100 kPa	7.53 (C·cm <sup>2</sup> )/W	14.82 (C·cm <sup>2</sup> )/W	19.48 (C·cm <sup>2</sup> )/W
	200 kPa	6.71 (C·cm <sup>2</sup> )/W	13.17 (C·cm <sup>2</sup> )/W	16.01 (C·cm <sup>2</sup> )/W
	300 kPa	5.90 (C·cm <sup>2</sup> )/W	10.73 (C·cm <sup>2</sup> )/W	11.38 (C·cm <sup>2</sup> )/W
Compressibility	100 kPa	4.93 %	4.05 %	4.43 %
	200 kPa	9.58 %	8.66 %	14.04 %
	300 kPa	18.41 %	22.13 %	40.49 %
Resistivity		> 10×10 <sup>14</sup> Ω·cm		
Dielectric voltage		> 17 kVac/mm		
Hardness (Type E)		39		
Adhesive force	SUS	39 mN/cm		
	Aluminum	31 mN/cm		
	Glass	38 mN/cm		

\* Characteristics refer to Elastomer resin only.

\*\* Values are for reference, not guaranteed.

Comparison of thermal conductivity (a-b plane)

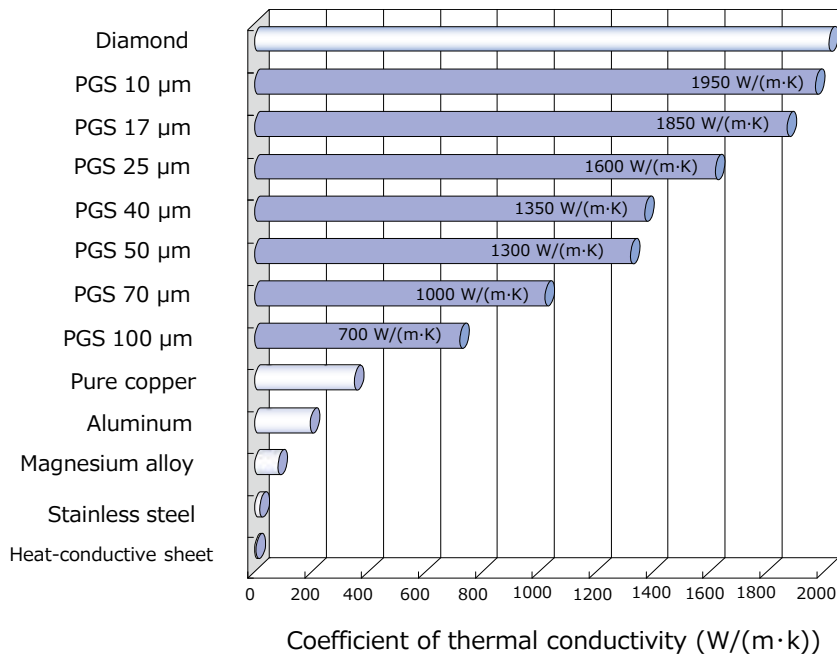

Layered structure of PGS



Electric field shield performance

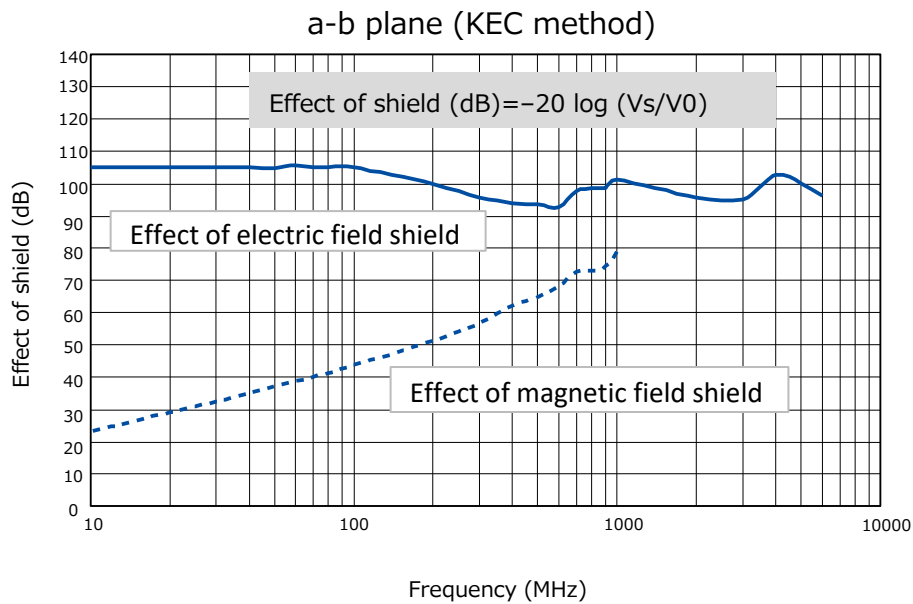

**Lamination type/Composition example**

- Standard series (PGS 100, 70, 50, 40, 25, 17, 10 μm)

Type	PGS Only	Adhesive Type		
	S type	A – A type	A – M type	A – F type
Front face	-	-	-	-
Rear face	-	Insulative adhesive tape 30 μm	Insulative adhesive tape 10 μm	Insulative adhesive tape 6 μm
Structure	<p>PGS Graphite Sheet</p> 	<p>PGS Graphite Sheet</p>  <p>Acrylic Adhesive tape 30 μm Separating paper</p>	<p>PGS Graphite Sheet</p>  <p>Acrylic Adhesive tape 10 μm Separating paper</p>	<p>PGS Graphite Sheet</p>  <p>Acrylic Adhesive tape 6 μm Separating paper</p>
Features	<ul style="list-style-type: none"> <li>◎High Thermal Conductivity</li> <li>High Flexibility</li> <li>◎Low Thermal Resistance</li> <li>◎Available up to 400 °C</li> <li>◎Conductive Material</li> </ul>	<ul style="list-style-type: none"> <li>◎With insulation material on one side</li> <li>◎With strong adhesive tape for putting chassis</li> <li>◎Withstanding Voltage : 2 kV</li> </ul>	<ul style="list-style-type: none"> <li>◎With insulation material on one side</li> <li>◎Low thermal resistance comparison with A-A type</li> <li>◎Withstanding Voltage : 1 kV</li> </ul>	<ul style="list-style-type: none"> <li>◎With insulation material on one side</li> <li>◎Low thermal resistance comparison with A-A type</li> </ul>
Withstand temperature	400 °C	100 °C	100 °C	100 °C
Standard size	115 × 180 mm	90 × 115 mm	90 × 115 mm	90 × 115 mm
Maximum size	180 × 230 mm (25 μm ~)	115 × 180 mm	115 × 180 mm	115 × 180 mm
100 μm	Part No.	EYGS121810	-	-
	Thickness	100 μm	-	-
70 μm	Part No.	EYGS121807	EYGA091207A	EYGA091207M
	Thickness	70 μm	100 μm	80 μm
50 μm	Part No.	EYGS121805	EYGA091205A	EYGA091205M
	Thickness	50 μm	80 μm	60 μm
40 μm	Part No.	EYGS121804	EYGA091204A	EYGA091204M
	Thickness	40 μm	70 μm	50 μm
25 μm	Part No.	EYGS121803	EYGA091203A	EYGA091203M
	Thickness	25 μm	55 μm	35 μm
17 μm	Part No.	-	EYGA091202A	EYGA091202M
	Thickness	-	47 μm	27 μm
10 μm	Part No.	-	EYGA091201A	EYGA091201M
	Thickness	-	40 μm	20 μm
				EYGA091201F
				16 μm

- \* Please contact us for other lamination type product.
- \*\* Withstanding Voltages are for reference, not guaranteed.

**Lamination type/Composition example**

● Standard series (PGS 100, 70, 50, 40, 25, 17, 10 μm)

Type	Laminated type (Insulation & Adhesive)			
	A – PA type	A – PM type	A – DM type	A – DF type
Front face	Polyester tape standard type 30 μm	Polyester tape standard type 30 μm	Polyester tape standard type 10 μm	Polyester tape standard type 10 μm
Rear face	Insulative adhesive tape 30 μm	Insulative adhesive tape 10 μm	Insulative adhesive tape 10 μm	Insulative adhesive tape 6 μm
Structure				
Features	<ul style="list-style-type: none"> <li>◎With insulation material on one side</li> <li>◎Withstanding Voltage PET tape : 4 kV</li> <li>Adhesive Tape : 2 kV</li> </ul>	<ul style="list-style-type: none"> <li>◎With insulation material on one side</li> <li>◎Withstanding Voltage PET tape : 4 kV</li> <li>Adhesive Tape : 1 kV</li> </ul>	<ul style="list-style-type: none"> <li>◎With insulation material on one side</li> <li>◎Withstanding Voltage PET tape : 1 kV</li> <li>Adhesive Tape : 1 kV</li> </ul>	<ul style="list-style-type: none"> <li>◎With insulation material on one side</li> <li>◎Withstanding Voltage PET tape : 1 kV</li> </ul>
Withstand temperature	100 °C	100 °C	100 °C	100 °C
Standard size	90 × 115 mm	90 × 115 mm	90 × 115 mm	90 × 115 mm
Maximum size	115 × 180 mm	115 × 180 mm	115 × 180 mm	115 × 180 mm
100 μm	Part No.	-	-	-
	Thickness	-	-	-
70 μm	Part No.	EYGA091207PA	EYGA091207PM	EYGA091207DM
	Thickness	130 μm	110 μm	90 μm
50 μm	Part No.	EYGA091205PA	EYGA091205PM	EYGA091205DM
	Thickness	110 μm	90 μm	70 μm
40 μm	Part No.	EYGA091204PA	EYGA091204PM	EYGA091204DM
	Thickness	100 μm	80 μm	60 μm
25 μm	Part No.	EYGA091203PA	EYGA091203PM	EYGA091203DM
	Thickness	85 μm	65 μm	45 μm
17 μm	Part No.	EYGA091202PA	EYGA091202PM	EYGA091202DM
	Thickness	77 μm	57 μm	37 μm
10 μm	Part No.	EYGA091201PA	EYGA091201PM	EYGA091201DM
	Thickness	70 μm	50 μm	30 μm

\* Please contact us for other lamination type product.  
 \*\* Withstanding Voltages are for reference, not guaranteed.

● Standard series (SSM)

Type	E-6 type	E-8 type	E-9 type
Elastomer thickness	1.0 mm	2.0 mm	3.0 mm
Structure			
Features	<ul style="list-style-type: none"> <li>◎Soft and low thermal resistance (Elastomer)</li> <li>◎Low repulsion</li> <li>◎Withstanding Voltage : 1.7 kV</li> </ul>	<ul style="list-style-type: none"> <li>◎Soft and low thermal resistance (Elastomer)</li> <li>◎Low repulsion</li> <li>◎Withstanding Voltage : 1.7 kV</li> </ul>	<ul style="list-style-type: none"> <li>◎Soft and low thermal resistance (Elastomer)</li> <li>◎Low repulsion</li> <li>◎Withstanding Voltage : 1.7 kV</li> </ul>
Withstand temperature	100 °C	100 °C	100 °C
Standard size	90 × 115 mm	90 × 115 mm	90 × 115 mm
70 μm	Part No.	EYGE0912XB6D	EYGE0912XB8D
	Thickness	1.09 mm	2.09 mm
25 μm	Part No.	EYGE0912XD6D	EYGE0912XD8D
	Thickness	1.05 mm	2.05 mm

Minimum order
---------------

Item	Type	Part No.	Size	Minimum order
PGS Graphite Sheet Only	S type 100 $\mu\text{m}$	EYGS091210	90×115 mm	20
		EYGS121810	115×180 mm	10
		EYGS182310	180×230 mm	10
	S type 70 $\mu\text{m}$	EYGS091207	90×115 mm	20
		EYGS121807	115×180 mm	10
		EYGS182307	180×230 mm	10
	S type 50 $\mu\text{m}$	EYGS091205	90×115 mm	20
		EYGS121805	115×180 mm	10
		EYGS182305	180×230 mm	10
	S type 40 $\mu\text{m}$	EYGS091204	90×115 mm	20
		EYGS121804	115×180 mm	10
		EYGS182304	180×230 mm	10
	S type 25 $\mu\text{m}$	EYGS091203	90×115 mm	20
		EYGS121803	115×180 mm	10
		EYGS182303	180×230 mm	10
PGS 70, 25, 17 $\mu\text{m}$ Adhesive Type [Standard series]	A – A type 70 $\mu\text{m}$	EYGA091207A	90×115 mm	20
		EYGA121807A	115×180 mm	10
	A – A type 25 $\mu\text{m}$	EYGA091203A	90×115 mm	20
		EYGA121803A	115×180 mm	10
	A – A type 17 $\mu\text{m}$	EYGA091202A	90×115 mm	20
		EYGA121802A	115×180 mm	10
	A – M type 70 $\mu\text{m}$	EYGA091207M	90×115 mm	20
		EYGA121807M	115×180 mm	10
	A – M type 25 $\mu\text{m}$	EYGA091203M	90×115 mm	20
		EYGA121803M	115×180 mm	10
	A – M type 17 $\mu\text{m}$	EYGA091202M	90×115 mm	20
		EYGA121802M	115×180 mm	10
PGS 70, 25, 17 $\mu\text{m}$ Laminated Type (Insulation & Adhesive) [Standard series]	A – PA type 70 $\mu\text{m}$	EYGA091207PA	90×115 mm	20
		EYGA121807PA	115×180 mm	10
	A – PA type 25 $\mu\text{m}$	EYGA091203PA	90×115 mm	20
		EYGA121803PA	115×180 mm	10
	A – PA type 17 $\mu\text{m}$	EYGA091202PA	90×115 mm	20
		EYGA121802PA	115×180 mm	10
	A – PM type 70 $\mu\text{m}$	EYGA091207PM	90×115 mm	20
		EYGA121807PM	115×180 mm	10
	A – PM type 25 $\mu\text{m}$	EYGA091203PM	90×115 mm	20
		EYGA121803PM	115×180 mm	10
	A – PM type 17 $\mu\text{m}$	EYGA091202PM	90×115 mm	20
		EYGA121802PM	115×180 mm	10
	A – DM type 70 $\mu\text{m}$	EYGA091207DM	90×115 mm	20
		EYGA121807DM	115×180 mm	10
	A – DM type 25 $\mu\text{m}$	EYGA091203DM	90×115 mm	20
		EYGA121803DM	115×180 mm	10
	A – DM type 17 $\mu\text{m}$	EYGA091202DM	90×115 mm	20
		EYGA121802DM	115×180 mm	10

- (1) Only S type supports 180×230 mm size.  
(PGS thickness of 17  $\mu\text{m}$ , 10 $\mu\text{m}$  does not support as single item)
- (2) PGS of 10  $\mu\text{m}$ , 40  $\mu\text{m}$ , 50  $\mu\text{m}$  type is also possible to be made as lamination type.
- (3) The above-listed part number is sample part number for testing.
- (4) Please contact us about your request of custom part number which will be arranged separately.
- (5) Please contact us if quantity is below Minimum Order Quantity.

<b>Minimum order</b>
----------------------

Item	Type	Part No.	Size	Minimum order
SSM  Elastomer 3.0, 2.0, 1.0 mm PGS 70, 25 μm	E – 9 type Elastomer 3.0 mm, PGS 70 μm	EYGE0912XB9D	90×115 mm	5
	E – 9 type Elastomer 3.0 mm, PGS 25 μm	EYGE0912XD9D	90×115 mm	5
	E – 8 type Elastomer 2.0 mm, PGS 70 μm	EYGE0912XD9D	90×115 mm	5
	E – 8 type Elastomer 2.0 mm, PGS 25 μm	EYGE0912XD8D	90×115 mm	5
	E – 6 type Elastomer 1.0 mm, PGS 70 μm	EYGE0912XB6D	90×115 mm	5
	E – 6 type Elastomer 1.0 mm, PGS 25 μm	EYGE0912XD6D	90×115 mm	5

- (1) Only S type supports 180×230 mm size.  
(PGS thickness of 17 μm, 10μm does not support as single item)
- (2) PGS of 10 μm, 40 μm, 50 μm type is also possible to be made as lamination type.
- (3) The above-listed part number is sample part number for testing.
- (4) Please contact us about your request of custom part number which will be arranged separately.
- (5) Please contact us if quantity is below Minimum Order Quantity.



## Precautions on the whole

- Do not use the products beyond the descriptions in this catalog.
- This catalog guarantees the quality of the products as individual components.  
Before you use the products, please make sure to check and evaluate the products in the circumstance where they are installed in your product.
- This product was designed and manufactured for standard applications such as general electronics devices, office equipment, information and communications equipment, measuring instruments, household appliances and audio-video equipment.  
For applications in which special quality and reliability are required, or if the failure or malfunction of the products may directly jeopardize life or cause threat of personal injury (such as for aircraft and aerospace equipment, traffic and transport equipment, combustion equipment, medical equipment, accident prevention and anti-theft devices, and safety equipment), please be sure to consult with our sales representative in advance and to exchange product catalog which conform to such applications.

## Safety and Design considerations

- We are trying to improve the quality and the reliability, but the durability differs depending on the use environment and the use conditions. On use, be sure to confirm the actual product under the actual use conditions.
- Install the following systems for a failsafe design to ensure safety if these products are to be used in equipment where a defect in these products may cause the loss of human life or other significant damage, such as damage to vehicles (automobile, train, vessel), traffic lights, medical equipment, aerospace equipment, electric heating appliances, combustion/ gas equipment, rotating equipment, and disaster/crime prevention equipment.
  - The system is equipped with a protection circuit and protection device.
  - The system is equipped with a redundant circuit or other system to prevent an unsafe status in the event of a single fault.
  - The system is equipped with an arresting the spread of fire or preventing glitch.
- When a dogma shall be occurred about safety for this product, be sure to inform us rapidly, operate your technical examination.
- The temperature of this product at the time of use changes depending on mounting conditions and usage conditions, therefore, please confirm that the temperature of this product is the specified temperature after mounting it.
- This product does not take the use under the following special environments into consideration. Accordingly, the use in the following special environments, and such environmental conditions may affect the performance of the product; prior to use, verify the performance, reliability, etc. thoroughly.
  - 1) Use in liquids such as water, oil, chemical, and organic solvent.
  - 2) Use under direct sunlight, in outdoor or in dusty atmospheres.
  - 3) Use in places full of corrosive gases such as sea breeze,  $C_{12}$ ,  $H_2S$ ,  $NH_3$ ,  $SO_2$ , and  $NO_x$ .
  - 4) Use the product in a contaminated state.
  - 5) Use in acid.
  - 6) Use outside the range defined by the operating temperature range.
  - 7) Use under reduced pressure or vacuum.

## Precaution of installation

- Do not reuse this product after removal from the mounting board.
- Do not drop this product on the floor. If this product is dropped, it can be damaged mechanically. Avoid using the dropped product.
- This product is soft, do not rub or touch it with rough materials to avoid scratching it.
- Lines or folds in this product may affect thermal conductivity.
- Never touch a this product during use because it may be extremely hot.
- Use protective materials when handling and/or applying this product, do not use items with sharp edges as they might tear or puncture this product.
- Do not handle with bare hands as there is a concern about performance degradation.

## Precaution on storage conditions

- Storage period is less than one year after our shipping inspection is completed. Please use within the period.
- If the product is stored in the following environments and conditions, the performance may be badly affected, avoid the storage in the following environments.
  - (1) Storage in places full of corrosive gases such as sea breeze,  $\text{Cl}_2$ ,  $\text{H}_2\text{S}$ ,  $\text{NH}_3$ ,  $\text{SO}_2$ , and  $\text{NO}_x$ .
  - (2) Storage in places exposed to ultraviolet light.
    - \*Recommended storage in the dark.
  - (3) Store at a temperature outside the storage temperature range specified by this catalog.
- In the case of a product configuration that assumes bonding, please use after checking the adhesiveness of the product when the storage period is over.

## Precaution specific to this product

- This product has conductivity. If required, This product should be provided insulation.
- This product can not guarantee the insulation because there is a concern for powder falling off of conductive materials.
- Thermal conductivity is dependent on the way it is used. Test the adaptability of the product to your application before use.

## Applicable laws and regulations, others

- No ODCs or other ozone-depleting substances which are subject to regulation under the Montreal Protocol are used in our manufacturing processes, including in the manufacture of this product.
- This product complies with the RoHS Directive (Restriction of the use of certain Hazardous Substances in electrical and electronic equipment (DIRECTIVE 2011/65/EU and (EU)2015/863) .
- All the materials used in this part are registered material under the Law Concerning the Examination and Regulation of Manufactures etc. of Chemical substances.
- If you need the notice by letter of "A preliminary judgment on the Laws of Japan foreign exchange and Foreign Trade control", be sure to let us know.
- These products are not dangerous goods on the transportation as identified by UN(United Nations) numbers or UN classification.
- As to the disposal of the module, check the method of disposal in each country or region where the modules are incorporated in your products to be used.
- The technical information in this catalog provides examples of our products typical operations and application circuits. We do not guarantee the non-infringement of third party's intellectual property rights and we do not grant any license, right, or interest in our intellectual property.

## "NASBIS" Insulating Sheet

Type: EYGY



"NASBIS" is a heat insulating sheet, which is composed of silica aerogel and fiber sheet, created through impregnation process. Pore size of silica aerogel is 10 to 60nm, which means it has smaller space than the mean free path of the air, 68nm. Air molecules do not collide against each other inside the pores, and thus the component shows excellent heat insulation performance.

Furthermore, combining NASBIS and PGS Graphite Sheet enables controlling the direction of heat. Composite type provides greater heat insulating performance.

### Features

- Low thermal conductivity : 0.020 W/m · K typ.
- Created thin-film sheet ; Thickness : 100 μm to 1000 μm
- Various proposals are available when combined with PGS Graphite sheet
- RoHS compliant

### Recommended applications

- Smartphone, Wearable equipment, Digital Still Camera, Notebook PCs, Tablet PCs

### Explanation of Part Numbers

- NASBIS Pouch Type (EYGY0912QNP)



\* Please consult the other configurations separately.

### Characteristics of NASBIS

Thickness	100 μm	500 μm	1000 μm
Thermal conductivity (W/(m·K))	0.018 to 0.026	0.018 to 0.026	0.018 to 0.026
Operating temperature limit (°C)	-20 to 100	-20 to 100	-20 to 100
Size / Laminate pouch (mm)	90 × 115	90 × 115	90 × 115
Heatproof temperature (°C)	100	100	100

Typical values, not guaranteed.

## Appearance of silica aerogel and its nanostructure

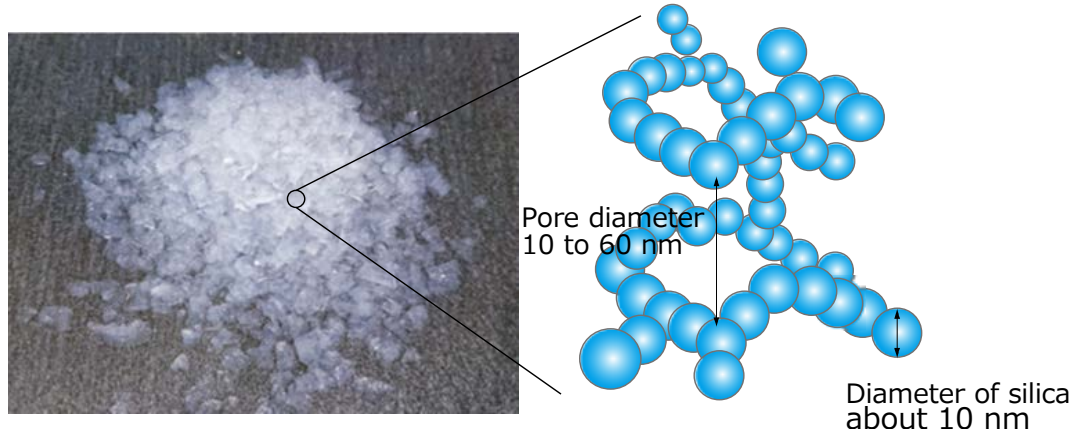

## Composition example

### ● NASBIS Pouch Type

Type		Y - P type
Structure		PET 30 μm
		NASBIS*
		Adhesive 10 μm
Heatproof temperature		100 °C
100 μm*	Part No.	EYGY0912QN6P
	Thickness (μm)	140
500 μm*	Part No.	EYGY0912QN4P
	Thickness (μm)	540
1000 μm*	Part No.	EYGY0912QN3P
	Thickness (μm)	1040

\* Above listed Part No. are examples for evaluation and selection, not for mass production. Customized service available for mass production spec.

■ Minimum order 10 pcs

## ⚠ Precautions on the whole

- Do not use the products beyond the descriptions in this catalog.
- This catalog guarantees the quality of the products as individual components.  
Before you use the products, please make sure to check and evaluate the products in the circumstance where they are installed in your product.
- This product was designed and manufactured for standard applications such as general electronics devices, office equipment, information and communications equipment, measuring instruments, household appliances and audio-video equipment.  
For applications in which special quality and reliability are required, or if the failure or malfunction of the products may directly jeopardize life or cause threat of personal injury (such as for aircraft and aerospace equipment, traffic and transport equipment, combustion equipment, medical equipment, accident prevention and anti-theft devices, and safety equipment), please be sure to consult with our sales representative in advance and to exchange product catalog which conform to such applications.

## Safety and Design considerations

- We are trying to improve the quality and the reliability, but the durability differs depending on the use environment and the use conditions. On use, be sure to confirm the actual product under the actual use conditions.
- Install the following systems for a failsafe design to ensure safety if these products are to be used in equipment where a defect in these products may cause the loss of human life or other significant damage, such as damage to vehicles (automobile, train, vessel), traffic lights, medical equipment, aerospace equipment, electric heating appliances, combustion/ gas equipment, rotating equipment, and disaster/crime prevention equipment.
  - The system is equipped with a protection circuit and protection device.
  - The system is equipped with a redundant circuit or other system to prevent an unsafe status in the event of a single fault.
  - The system is equipped with an arresting the spread of fire or preventing glitch.
- When a dogma shall be occurred about safety for this product, be sure to inform us rapidly, operate your technical examination.
- The temperature of this product at the time of use changes depending on mounting conditions and usage conditions, therefore, please confirm that the temperature of this product is the specified temperature after mounting it.
- This product does not take the use under the following special environments into consideration. Accordingly, the use in the following special environments, and such environmental conditions may affect the performance of the product; prior to use, verify the performance, reliability, etc. thoroughly.
  - 1) Use in liquids such as water, oil, chemical, and organic solvent.
  - 2) Use under direct sunlight, in outdoor or in dusty atmospheres.
  - 3) Use in places full of corrosive gases such as sea breeze,  $C_{12}$ ,  $H_2S$ ,  $NH_3$ ,  $SO_2$ , and  $NO_x$ .
  - 4) Use the product in a contaminated state.
  - 5) Use in the point being adhered to organic solvent (thinner, alcohol, xylene etc.) or chemical substances (oils, acids, alkali etc.), or being possible to contact with their.  
And use under their gas atmosphere.
  - 6) Use in an environment in contact with silicone resin.
  - 7) Use with ultrasonic and high frequency wave applied.
  - 8) Use under reduced pressure or vacuum.

## Precaution of installation

- Do not reuse this product after removal from the mounting board.
- Do not drop this product on the floor. If this product is dropped, it can be damaged mechanically. Avoid using the dropped product.
- Do not touch this product with bare hands.
- This product is soft, do not rub or touch it with rough and sharp-edged materials to avoid scratching it.
- Lines or folds in this product may affect thermal insulation.
- Never touch a this product during use because it may be extremely hot.

- Use protective materials when handling and/or applying this product, do not use items with sharp edges as they might tear or puncture this product.
- The NASBIS shall not be modified and done additional work such as cutting, drilling, nailing, eyelets, screwing, pinning, riveting, polishing, embossing, water cleaning, solvent cleaning, ozone cleaning, plasma exposure, ultraviolet irradiation, plating, painting, printing, deposition, etching, sputtering, heat treatment, surface treatment.
- The NASBIS shall not be reused, repaired and recycled.

### Precaution on storage conditions

- Storage period is less than one year after our shipping inspection is completed.  
Please use within the period.
- If the product is stored in the following environments and conditions, the performance may be badly affected, avoid the storage in the following environments.
  - (1) Storage in places full of corrosive gases such as sea breeze, Cl<sub>2</sub>, H<sub>2</sub>S, NH<sub>3</sub>, SO<sub>2</sub>, and NO<sub>x</sub>.
  - (2) Storage in places exposed to ultraviolet light. \*Recommended storage in the dark.
  - (3) Store at a temperature outside the storage temperature range specified by this catalog.
  - (4) Storage under a load.
- In the case of a product configuration that assumes bonding, please use after checking the adhesiveness of the product when the storage period is over.

### Precaution specific to this product

- NASBIS sheet may release silica powder (electric non-conduct).
- The adhesion between laminate film and NASBIS is very weak, so some parts may be un-bonded depending on the handling.
- The performance of thermal insulation is dependent on the way it is used. Test the adaptability of NASBIS to your application before use.
- The dimension of NASBIS sheet will change when the humidity changes. If you need a precise size we suggest that the NASBIS sheet should be controlled at a certain stored condition and period, and measured at the same conditions.  
ex) The dimensions of NASBIS are assured when stored and measured at 23±2 °C、50±20 %RH.
- The appearance is conducted based on internal standard. When suspicion arises, contact promptly us.

### Applicable laws and regulations, others

- No ODCs or other ozone-depleting substances which are subject to regulation under the Montreal Protocol are used in our manufacturing processes, including in the manufacture of this product.
- This product complies with the RoHS Directive (Restriction of the use of certain Hazardous Substances in electrical and electronic equipment (DIRECTIVE 2011/65/EU and (EU)2015/863) .
- All the materials used in this part are registered material under the Law Concerning the Examination and Regulation of Manufactures etc. of Chemical substances.
- If you need the notice by letter of "A preliminary judgment on the Laws of Japan foreign exchange and Foreign Trade control", be sure to let us know.
- These products are not dangerous goods on the transportation as identified by UN(United Nations) numbers or UN classification.
- As to the disposal of the module, check the method of disposal in each country or region where the modules are incorporated in your products to be used.
- The technical information in this catalog provides examples of our products typical operations and application circuits. We do not guarantee the non-infringement of third party's intellectual property rights and we do not grant any license, right, or interest in our intellectual property.



## “Graphite-PAD” high thermal conductivity in z-direction

Type: **EYGT**



Graphite-PAD is a thermal interface material (TIM) that compatibly obtained excellent thermal conductivity in thickness direction (Z-axis direction) and high flexibility (deformable with a low load). The properties are greater than that of existing TIMs. The product is created by filling PGS Graphite Sheet into silicon resin.

### Features

- High thermal conductivity : 13 W/m · K
- Excellent compressibility : 50 % (t=2 mm, Pressure 300 kPa)
- Thermal resistance: fit into uneven parts and provide excellent thermal resistance with a low load
- High reliability : correspond to -40 to 150 °C and maintains long-term reliability
- Thickness range : 0.5/1.0/1.5/2.0/2.5/3.0 mm
- RoHS compliant

### Recommended applications

Cooling of heat generating components, such as electronic devices, semiconductor memory device, etc.

- General-purpose inverter, medical equipment, and DSC
- Car-mounted camera, motor control unit, automotive lighting (LED), car navigation, luminous source of laser HUD
- Base station, IGBT module

### Explanation of Part Numbers

- Graphite-PAD (EYGT\*\*\*\*\*A)

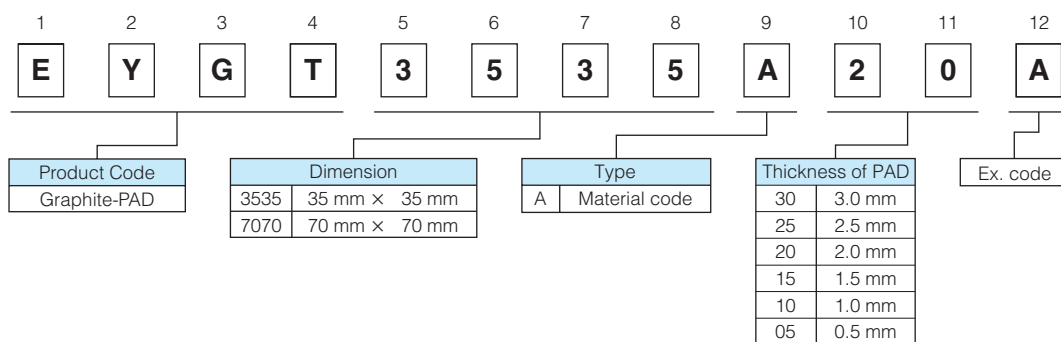

\* Please confirm other condition separately.

### Typical characteristics

Items	Test equipment/method	Condition	Data					
			0.5	1.0	1.5	2.0	2.5	3.0
Thickness (mm)			0.5	1.0	1.5	2.0	2.5	3.0
Thermal resistance (K·cm <sup>2</sup> /W)	TIM Tester	100 kPa	0.96	1.34	1.56	1.93	2.10	2.36
Compressibility (%)	TIM Tester	100 kPa (50 °C)	5.78	10.29	17.46	17.8	17.6	17.9
Thermal conductivity of Graphite-PAD with a unit (W/m·K) (including contact resistance)	TIM Tester	100 kPa	5.08	7.02	7.80	8.60	9.66	10.10
Thermal conductivity of the Graphite-PAD (W/m·K)	(ASTM D5470)	50 kPa	13					
Hardness	(ASTM D2240)	TYPE E	25					
Adhesive			Adhesive on both faces					
Volume resistivity (Ω·cm)	(ASTM D257)		4×10 <sup>5</sup>					
Operating temperature range (°C)			-40 to 150					
Siloxane		Σ (D4-D10)	≤ 70 ppm					

### Structure



### Thermal resistance and Compressibility



## Composition example

Structure			
Operating temperature range		-40 °C to 150 °C	
Standard dimension		35 × 35 mm	70 × 70 mm
0.5 mm	Standard Part No.	EYGT3535A05A	EYGT7070A05A
	Thickness	0.5 mm	0.5 mm
1.0 mm	Standard Part No.	EYGT3535A10A	EYGT7070A10A
	Thickness	1.0 mm	1.0 mm
1.5 mm	Standard Part No.	EYGT3535A15A	EYGT7070A15A
	Thickness	1.5 mm	1.5 mm
2.0 mm	Standard Part No.	EYGT3535A20A	EYGT7070A20A
	Thickness	2.0 mm	2.0 mm
2.5 mm	Standard Part No.	EYGT3535A25A	EYGT7070A25A
	Thickness	2.5 mm	2.5 mm
3.0 mm	Standard Part No.	EYGT3535A30A	EYGT7070A30A
	Thickness	3.0 mm	3.0 mm

\* Part numbers listed above are all standard samples for your consideration.

\*\* Contact us for custom-made samples.

We can make samples in various forms and/or dimensions other than standard samples.

## Precautions on the whole

- Do not use the products beyond the descriptions in this catalog.
- This catalog guarantees the quality of the products as individual components.  
Before you use the products, please make sure to check and evaluate the products in the circumstance where they are installed in your product.
- This product was designed and manufactured for standard applications such as general electronics devices, office equipment, information and communications equipment, measuring instruments, household appliances and audio-video equipment.  
For applications in which special quality and reliability are required, or if the failure or malfunction of the products may directly jeopardize life or cause threat of personal injury (such as for aircraft and aerospace equipment, traffic and transport equipment, combustion equipment, medical equipment, accident prevention and anti-theft devices, and safety equipment), please be sure to consult with our sales representative in advance and to exchange product catalog which conform to such applications.

## Safety and Design considerations

- We are trying to improve the quality and the reliability, but the durability differs depending on the use environment and the use conditions. On use, be sure to confirm the actual product under the actual use conditions.
- Install the following systems for a failsafe design to ensure safety if these products are to be used in equipment where a defect in these products may cause the loss of human life or other significant damage, such as damage to vehicles (automobile, train, vessel), traffic lights, medical equipment, aerospace equipment, electric heating appliances, combustion/ gas equipment, rotating equipment, and disaster/crime prevention equipment.
  - The system is equipped with a protection circuit and protection device.
  - The system is equipped with a redundant circuit or other system to prevent an unsafe status in the event of a single fault.
  - The system is equipped with an arresting the spread of fire or preventing glitch.
- When a dogma shall be occurred about safety for this product, be sure to inform us rapidly, operate your technical examination.
- The temperature of this product at the time of use changes depending on mounting conditions and usage conditions, therefore, please confirm that the temperature of this product is the specified temperature after mounting it.
- This product does not take the use under the following special environments into consideration. Accordingly, the use in the following special environments, and such environmental conditions may affect the performance of the product; prior to use, verify the performance, reliability, etc. thoroughly.
  - 1) Use in liquids such as water, oil, chemical, and organic solvent.
  - 2) Use under direct sunlight, in outdoor or in dusty atmospheres.
  - 3) Use in places full of corrosive gases such as sea breeze, C<sub>12</sub>, H<sub>2</sub>S, NH<sub>3</sub>, SO<sub>2</sub>, and NO<sub>x</sub>.
  - 4) Use the product in a contaminated state.
  - 5) Use in acid.
  - 6) Use outside the range defined by the operating temperature range.
  - 7) Use under reduced pressure or vacuum.

## Precaution of installation

- Do not reuse this product after removal from the mounting board.
- Do not drop this product on the floor. If this product is dropped, it can be damaged mechanically. Avoid using the dropped product.
- This product is soft, do not rub or touch it with rough materials to avoid scratching it.
- Lines or folds in this product may affect thermal conductivity.
- Never touch a this product during use because it may be extremely hot.
- Use protective materials when handling and/or applying this product, do not use items with sharp edges as they might tear or puncture this product.
- Do not handle with bare hands as there is a concern about performance degradation.

## Precaution on storage conditions

- Storage period is less than one year after our shipping inspection is completed. Please use within the period.
- If the product is stored in the following environments and conditions, the performance may be badly affected, avoid the storage in the following environments.
  - (1) Storage in places full of corrosive gases such as sea breeze, Cl<sub>2</sub>, H<sub>2</sub>S, NH<sub>3</sub>, SO<sub>2</sub>, and NO<sub>x</sub>.
  - (2) Storage in places exposed to ultraviolet light.
    - \*Recommended storage in the dark.
  - (3) Store at a temperature outside the storage temperature range specified by this catalog.
- In the case of a product configuration that assumes bonding, please use after checking the adhesiveness of the product when the storage period is over.

## Precaution specific to this product

- This product has conductivity. If required, This product should be provided insulation.
- This product can not guarantee the insulation because there is a concern for powder falling off of conductive materials.
- Thermal conductivity is dependent on the way it is used. Test the adaptability of the product to your application before use.

## Applicable laws and regulations, others

- No ODCs or other ozone-depleting substances which are subject to regulation under the Montreal Protocol are used in our manufacturing processes, including in the manufacture of this product.
- This product complies with the RoHS Directive (Restriction of the use of certain Hazardous Substances in electrical and electronic equipment (DIRECTIVE 2011/65/EU and (EU)2015/863) .
- All the materials used in this part are registered material under the Law Concerning the Examination and Regulation of Manufactures etc. of Chemical substances.
- If you need the notice by letter of "A preliminary judgment on the Laws of Japan foreign exchange and Foreign Trade control", be sure to let us know.
- These products are not dangerous goods on the transportation as identified by UN(United Nations) numbers or UN classification.
- As to the disposal of the module, check the method of disposal in each country or region where the modules are incorporated in your products to be used.
- The technical information in this catalog provides examples of our products typical operations and application circuits. We do not guarantee the non-infringement of third party's intellectual property rights and we do not grant any license, right, or interest in our intellectual property.

### “GraphiteTIM(Compressible Type)” PGS with low thermal resistance

Type: **EYGS**



GraphiteTIM(Compressible Type) is a graphite sheet that is dedicated for use as a thermal interface material.

The GraphiteTIM(Compressible Type) has very high compressibility compared to standard PGS, which enables reducing the thermal resistance by following gap, warpage, and distortion of targets/substrates. Excellent heat resistance and reliability of the GraphiteTIM help obtaining longer service life and higher performance of various components, such as power modules.

The GraphiteTIM(Compressible Type) is cost-saving, because it may allow you to reduce your existing processes. Unlike grease, there is no necessity for printing process, since it is a sheet-type product.

There are no problems that are found in grease and phase change materials in the GraphiteTIM, which makes it excellent TIM.

#### Features

- Thermal resistance : 0.2K·cm<sup>2</sup>/W (600 kPa)  
To draw a good thermal resistance from sheet, pressure the GraphiteTIM. A close adherence would make the product fit into the uneven part and enhance the performance.
- Thermal conductivity : X-Y direction 400W/m·K, Z direction (28W/m·K)
- Compressibility : 40 % (600k Pa)
- High and long term reliability : operating temperature range -55 to 400 °C
- RoHs compliant



After pressure

#### Recommended applications

For cooling/heat transfer of electronic devices that generates heat, such as power modules.

- Inverters and converters
- Car-mounted camera, motor control unit, automotive LED, luminous source of laser HUD, medical equipment
- Base station, Server

Install in IGBT module

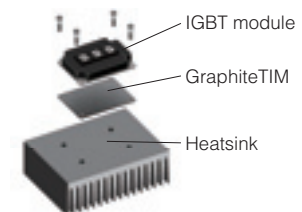

#### Explanation of Part Numbers

- GraphiteTIM(EYGS\*\*\*\*ZL\*\*)



\* Please contact us for custom-made products.

### Typical characteristics

Items	Test method	Condition	Data
Thickness ( $\mu\text{m}$ )			200
Thermal resistance ( $\text{K}\cdot\text{cm}^2/\text{W}$ )	TIM Tester	600 kPa	0.2
Compressibility (%)	TIM Tester	600 kPa	40
Thermal conductivity ( $\text{W}/\text{m}\cdot\text{K}$ )	Laser PIT	X-Y	400 (300 to 600)
		Z	(28)
Flame resistance	UL-94V		V-0
Operating temperature range ( $^{\circ}\text{C}$ )			-55 to 400

Typical values, not guaranteed.

### Thermal resistance and compressibility

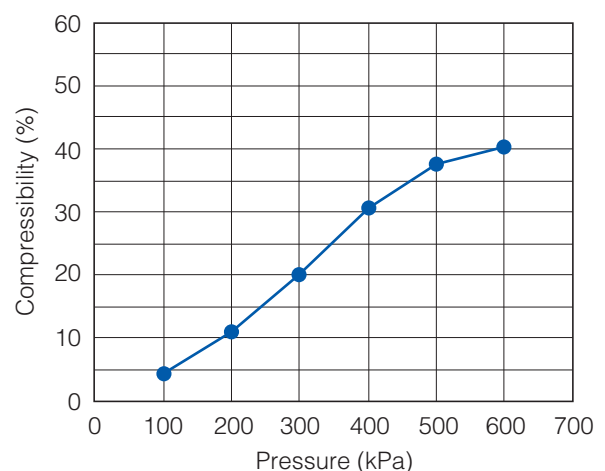

### Lamination type/Composition example

- GraphiteTIM(Compressible Type) standard form

Type		Sheet only
		S Type
Process for IGBT mounting		-
Structure	Front	
	Side	
Operating Temperature Range		-55 to 400 $^{\circ}\text{C}$
Thickness: c		200 $\mu\text{m}$
Standard Part No.	90 × 90 mm	EYGS0909ZLX2
	90 × 180 mm	EYGS0918ZLX2
	180 × 180 mm	EYGS1818ZLX2

\* Part numbers listed above are all standard samples for your consideration.

\*\* Contact us for custom-made samples.

We can make samples in various forms and/or dimensions other than standard samples.



● PGS in IGBT forms

Type		Sheet only
		S Type
Process for IGBT mounting		Lamination
Structure	Front	 <p>* This shape is an example, please contact us for detailed shape of each part no.</p>
	Side	
Operating Temperature Range		-55 to 400 °C
Thickness: c		200 μm

No.	Standard Part No.	a : Lateral size (mm)	b : Longitudinal size (mm)	Hole number	Hole diameter (φmm)	d : Lateral hole pitch (mm)	e : Longitudinal hole pitch (mm)
1	EYGS1431ZLAA	140	308	12	6	126	290
2	EYGS0925ZLWA	85	246	14	6	73	234
3	EYGS1419ZLWB	136	186	8	7.5	124	171
4	EYGS0917ZLWC	85	168	10	6	73	156
5	EYGS1316ZLAC	125	163	8	6.1	110	150
6	EYGS1216ZLWD	120	160	8	6	110	150
7	EYGS1116ZLMA	108.8	158	8	6	92.75	144
8	EYGS1315ZLGA	129.5	150	8	7	118.5	137.5
9	EYGS1314ZLWE	126	136	6	7.5	114	124
10	EYGS1014ZLAD	97.8	138	4	6.8	86	127
11	EYGS0714ZLAE	70	138	4	5.7	57	128
12	EYGS0714ZLAF	69	136	4	7.2	57	124
13	EYGS1113ZLMB	106	132	4	5.7	95	121
14	EYGS1313ZLGB	128	128	4	6.7	110	110
15	EYGS0713ZLAG	66	126	4	5.7	50	116
16	EYGS0813ZLMD	71	123	2	4.7	Center	116
17	EYGS1212ZLGC	120	120	4	5.7	110	110
18	EYGS0912ZLGD	88	120	4	5.7	78	110
19	EYGS0612ZLWF	60	120	4	5.7	50	110
20	EYGS0512ZLGE	53	118	2	5.7	Center	106
21	EYGS0811ZLGH	80	113	4	5.7	70	103
22	EYGS0811ZLWG	78	108	4	6.7	62	93
23	EYGS0611ZLWH	60	106	4	6.7	48	93
24	EYGS0411ZLWJ	43	105.5	2	5.7	Center	93
25	EYGS0610ZLAH	59.4	104.4	4	6.7	48	93
26	EYGS0410ZLAJ	43	102.8	2	5.7	Center	93
27	EYGS1010ZLME	98	98	4	6.7	87	87

No.	Standard Part No.	a : Lateral size (mm)	b : Longitudinal size (mm)	Hole number	Hole diameter (φmm)	d : Lateral hole pitch (mm)	e : Longitudinal hole pitch (mm)
28	EYGS0409ZLGJ	44	93	2	6.7	Center	80
29	EYGS0509ZLGK	46	92	2	6.7	Center	80
30	EYGS0309ZLMF	32	92	2	6.7	Center	80
31	EYGS0409ZLMG	41	88	2	5.7	Center	80
32	EYGS0309ZLAK	29.5	89.5	2	6.6	Center	80
33	EYGS0509ZLMH	51	86	2	4.7	–	80
34	EYGS0508ZLMJ	46.2	83	2	4.7	–	77
35	EYGS0608ZLMK	55	78	2	4.5	Center	40
36	EYGS0607ZLGL	58	69.7	4	5.7	50	62
37	EYGS0507ZLML	45.3	66	2	4.7	–	60
38	EYGS0407ZLAL	40	65.5	1	7.7	Center	Center
39	EYGS0506ZLMM	48	55	1	4.5	Center	Center
40	EYGS0404ZLMP	36	38	1	4.5	Center	Center
41	EYGS1018ZLSA	104.5	182.5	8	7	93	171
42	EYGS1516ZLSB	148	158	8	5	137	150
43	EYGS1116ZLSC	112	158	8	5	101	150
44	EYGS0715ZLSD	67	153	4	5.6	57	143
45	EYGS0613ZLSE	61	127.5	4	5.6	50	116
46	EYGS0612ZLSF	63.3	124	4	5.6	50	110
47	EYGS0612ZLSG	61.5	124	4	5.6	50	110
48	EYGS1012ZLSH	104.5	121	4	6.7	93	109.5
49	EYGS0410ZLSJ	43	103	2	5.7	Center	93
50	EYGS0609ZLSK	61.5	91	4	5.6	50	77
51	EYGS0606ZLSL	58	61.5	2	5.6	44	50
52	EYGS0305ZLSM	27	51	1	4.6	Center	Center
53	EYGS0204ZLSN	24	36.5	1	4.6	Center	Center
54	EYGS0303ZLSP	29	32	1	4.5	Center	Center
55	EYGS0911ZLDA	92	109	4	6	78	93
56	EYGS1014ZLDB	98	138	4	6.7	86	127

## Precautions on the whole

- Do not use the products beyond the descriptions in this catalog.
- This catalog guarantees the quality of the products as individual components.  
Before you use the products, please make sure to check and evaluate the products in the circumstance where they are installed in your product.
- This product was designed and manufactured for standard applications such as general electronics devices, office equipment, information and communications equipment, measuring instruments, household appliances and audio-video equipment.  
For applications in which special quality and reliability are required, or if the failure or malfunction of the products may directly jeopardize life or cause threat of personal injury (such as for aircraft and aerospace equipment, traffic and transport equipment, combustion equipment, medical equipment, accident prevention and anti-theft devices, and safety equipment), please be sure to consult with our sales representative in advance and to exchange product catalog which conform to such applications.

## Safety and Design considerations

- We are trying to improve the quality and the reliability, but the durability differs depending on the use environment and the use conditions. On use, be sure to confirm the actual product under the actual use conditions.
- Install the following systems for a failsafe design to ensure safety if these products are to be used in equipment where a defect in these products may cause the loss of human life or other significant damage, such as damage to vehicles (automobile, train, vessel), traffic lights, medical equipment, aerospace equipment, electric heating appliances, combustion/ gas equipment, rotating equipment, and disaster/crime prevention equipment.
  - The system is equipped with a protection circuit and protection device.
  - The system is equipped with a redundant circuit or other system to prevent an unsafe status in the event of a single fault.
  - The system is equipped with an arresting the spread of fire or preventing glitch.
- When a dogma shall be occurred about safety for this product, be sure to inform us rapidly, operate your technical examination.
- The temperature of this product at the time of use changes depending on mounting conditions and usage conditions, therefore, please confirm that the temperature of this product is the specified temperature after mounting it.
- This product does not take the use under the following special environments into consideration. Accordingly, the use in the following special environments, and such environmental conditions may affect the performance of the product; prior to use, verify the performance, reliability, etc. thoroughly.
  - 1) Use in liquids such as water, oil, chemical, and organic solvent.
  - 2) Use under direct sunlight, in outdoor or in dusty atmospheres.
  - 3) Use in places full of corrosive gases such as sea breeze, C<sub>12</sub>, H<sub>2</sub>S, NH<sub>3</sub>, SO<sub>2</sub>, and NO<sub>x</sub>.
  - 4) Use the product in a contaminated state.
  - 5) Use in acid.
  - 6) Use outside the range defined by the operating temperature range.
  - 7) Use under reduced pressure or vacuum.

## Precaution of installation

- Do not reuse this product after removal from the mounting board.
- Do not drop this product on the floor. If this product is dropped, it can be damaged mechanically. Avoid using the dropped product.
- This product is soft, do not rub or touch it with rough materials to avoid scratching it.
- Lines or folds in this product may affect thermal conductivity.
- Never touch a this product during use because it may be extremely hot.
- Use protective materials when handling and/or applying this product, do not use items with sharp edges as they might tear or puncture this product.
- Do not handle with bare hands as there is a concern about performance degradation.

## Precaution on storage conditions

- Storage period is less than one year after our shipping inspection is completed. Please use within the period.
- If the product is stored in the following environments and conditions, the performance may be badly affected, avoid the storage in the following environments.
  - (1) Storage in places full of corrosive gases such as sea breeze, Cl<sub>2</sub>, H<sub>2</sub>S, NH<sub>3</sub>, SO<sub>2</sub>, and NO<sub>x</sub>.
  - (2) Storage in places exposed to ultraviolet light.
    - \*Recommended storage in the dark.
  - (3) Store at a temperature outside the storage temperature range specified by this catalog.
- In the case of a product configuration that assumes bonding, please use after checking the adhesiveness of the product when the storage period is over.

## Precaution specific to this product

- This product has conductivity. If required, This product should be provided insulation.
- This product can not guarantee the insulation because there is a concern for powder falling off of conductive materials.
- Thermal conductivity is dependent on the way it is used. Test the adaptability of the product to your application before use.

## Applicable laws and regulations, others

- No ODCs or other ozone-depleting substances which are subject to regulation under the Montreal Protocol are used in our manufacturing processes, including in the manufacture of this product.
- This product complies with the RoHS Directive (Restriction of the use of certain Hazardous Substances in electrical and electronic equipment (DIRECTIVE 2011/65/EU and (EU)2015/863) .
- All the materials used in this part are registered material under the Law Concerning the Examination and Regulation of Manufactures etc. of Chemical substances.
- If you need the notice by letter of "A preliminary judgment on the Laws of Japan foreign exchange and Foreign Trade control", be sure to let us know.
- These products are not dangerous goods on the transportation as identified by UN(United Nations) numbers or UN classification.
- As to the disposal of the module, check the method of disposal in each country or region where the modules are incorporated in your products to be used.
- The technical information in this catalog provides examples of our products typical operations and application circuits. We do not guarantee the non-infringement of third party's intellectual property rights and we do not grant any license, right, or interest in our intellectual property.

### CAUTION AND WARNING

1. The electronic components contained in this catalog are designed and produced for use in home electric appliances, office equipment, information equipment, communications equipment, and other general purpose electronic devices.  
Before use of any of these components for equipment that requires a high degree of safety, such as medical instruments, aerospace equipment, disaster-prevention equipment, security equipment, vehicles (automobile, train, vessel), please be sure to contact our sales representative corporation.
2. When applying one of these components for equipment requiring a high degree of safety, no matter what sort of application it might be, be sure to install a protective circuit or redundancy arrangement to enhance the safety of your equipment. In addition, please carry out the safety test on your own responsibility.
3. When using our products, no matter what sort of equipment they might be used for, be sure to make a written agreement on the specifications with us in advance.
4. Technical information contained in this catalog is intended to convey examples of typical performances and or applications and is not intended to make any warranty with respect to the intellectual property rights or any other related rights of our company or any third parties nor grant any license under such rights.
5. In order to export products in this catalog, the exporter may be subject to the export license requirement under the Foreign Exchange and Foreign Trade Law of Japan.
6. No ozone-depleting substances (ODSs) under the Montreal Protocol are used in the manufacturing processes of Automotive & Industrial Systems Company, Panasonic Corporation.

● Please contact \_\_\_\_\_

● Factory \_\_\_\_\_

Device Solutions Business Division  
Industrial Solutions Company

**Panasonic**<sup>®</sup>

1006 Kadoma, Kadoma City, Osaka 571-8506,  
JAPAN

The information in this catalog is valid as of December 2019.