

## Multilayer NTC Thermistors

Series: **ERTJ**

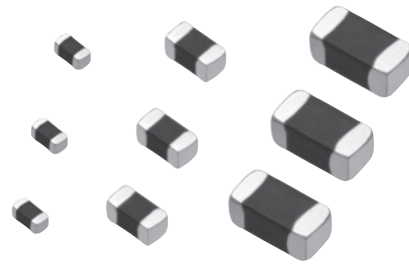

### Features

- Surface Mount Device (0201, 0402, 0603)
- Highly reliable multilayer / monolithic structure
- Wide temperature operating range (-40 to 125 °C)
- Environmentally-friendly lead-free
- RoHS compliant

### Recommended Applications

- Mobile Phone
  - Temperature compensation for crystal oscillator
  - Temperature compensation for semiconductor devices
- Personal Computer and Peripheral Device
  - Temperature detection for CPU and memory device
  - Temperature compensation for ink-viscosity (Inkjet Printer)
- Battery Pack (secondary battery)
  - Temperature detection of battery cells
- Liquid Crystal Display
  - Temperature compensation of display contrast
  - Temperature compensation of display backlighting (CCFL)

### Explanation of Part Numbers

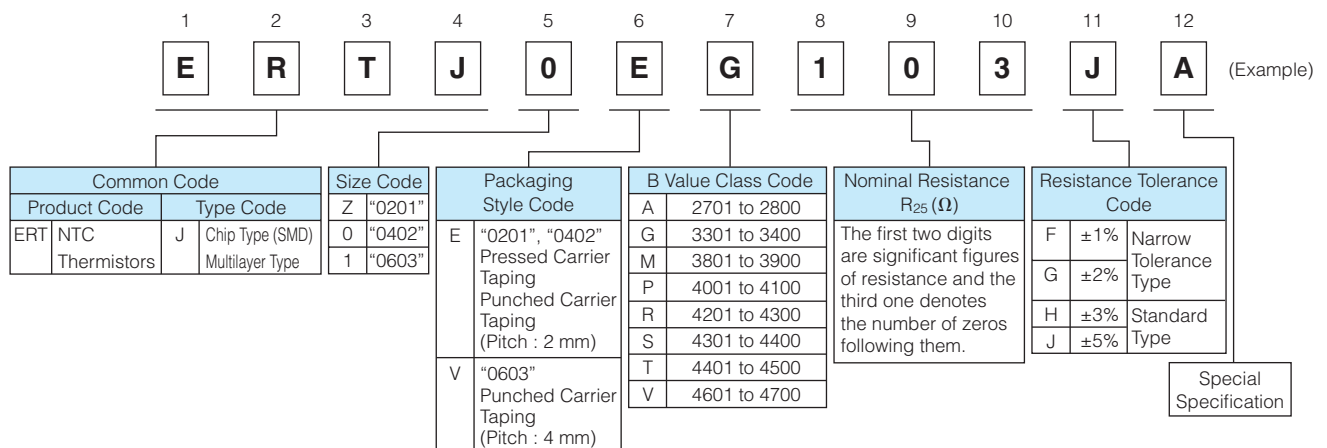

### Construction



No.	Name	
①	Semiconductive Ceramics	
②	Internal electrode	
③	Terminal electrode	Substrate electrode
④		Intermediate electrode
⑤		External electrode

## Ratings

Size code (EIA)	Z(0201)	O(0402)	1(0603)
Operating Temperature Range	-40 to 125 °C		
Rated Maximum Power Dissipation*1	33 mW	66 mW	100 mW
Dissipation Factor*2	Approximately 1 mW/°C	Approximately 2 mW/°C	Approximately 3 mW/°C

- \*1 Rated Maximum Power Dissipation : The maximum power that can be continuously applied at the rated ambient temperature.  
 ·The maximum value of power, and rated power is same under the condition of ambient temperature 25 °C or less. If the temperature exceeds 25 °C, rated power depends on the decreased power dissipation curve.  
 ·Please see "Operating Power" for details.
- \*2 Dissipation factor : The constant amount power required to raise the temperature of the Thermistor 1 °C through self heat generation under stable temperatures.  
 ·Dissipation factor is the reference value when mounted on a glass epoxy board (1.6 mmT).

## Part Number List of Narrow Tolerance Type (Resistance Tolerance : ±2 %, ±1 %)

### ● 0201(EIA)

Part Number	Nominal Resistance at 25 °C	Resistance Tolerance	B Value at 25/50(K)	B Value at 25/85(K)
ERTJZEG103□A	10 kΩ	±1 % (F) or ±2 % (G)	(3380 K)	3435 K±1%
ERTJZEP473□	47 kΩ		4050 K±1 %	(4100 K)
ERTJZEP683□	68 kΩ		4050 K±1 %	(4100 K)
ERTJZER683□	68 kΩ		4250 K±1 %	(4300 K)
ERTJZER104□	100 kΩ		4250 K±1 %	(4300 K)
ERTJZET104□	100 kΩ		4500 K±1 %	(4550 K)
ERTJZEV104□	100 kΩ		4700 K±1 %	(4750 K)

□ : Resistance Tolerance Code

### ● 0402(EIA)

Part Number	Nominal Resistance at 25 °C	Resistance Tolerance	B Value at 25/50(K)	B Value at 25/85(K)
ERTJ0EG103□A	10 kΩ	±1 % (F) or ±2 % (G)	(3380 K)	3435 K±1 %
ERTJ0EP333□	33 kΩ		4050 K±1 %	(4100 K)
ERTJ0EP473□	47 kΩ		4050 K±1 %	(4100 K)
ERTJ0EP683□	68 kΩ		4050 K±1 %	(4100 K)
ERTJ0ER104□	100 kΩ		4250 K±1 %	(4300 K)
ERTJ0ES104□	100 kΩ		4330 K±1 %	(4390 K)
ERTJ0EV104□	100 kΩ		4700 K±1 %	(4750 K)
ERTJ0EV224□	220 kΩ		4700 K±1 %	(4750 K)

□ : Resistance Tolerance Code

### ● 0603(EIA)

Part Number	Nominal Resistance at 25 °C	Resistance Tolerance	B Value at 25/50(K)	B Value at 25/85(K)
ERTJ1VG103□A	10 kΩ	±1 % (F) or ±2 % (G)	(3380 K)	3435 K±1 %
ERTJ1VS104□A	100 kΩ		(4330 K)	4390 K±1 %

□ : Resistance Tolerance Code

## Part Number List of Standard Type (Resistance Tolerance : ±5 %, ±3 %)

### ● 0201(EIA)

Part Number	Nominal Resistance at 25 °C	Resistance Tolerance	B Value at 25/50(K)	B Value at 25/85(K)
ERTJZET202□	2.0 kΩ	±3 % (H) or ±5 % (J)	4500 K±2 %	(4450 K)
ERTJZET302□	3.0 kΩ		4500 K±2 %	(4450 K)
ERTJZET472□	4.7 kΩ		4500 K±2 %	(4450 K)
ERTJZEG103□A	10 kΩ		(3380 K)	3435 K±1 %
ERTJZEP473□	47 kΩ		4050 K±2 %	(4100 K)
ERTJZEP683□	68 kΩ		4050 K±2 %	(4100 K)
ERTJZER683□	68 kΩ		4250 K±2 %	(4300 K)
ERTJZER104□	100 kΩ		4250 K±2 %	(4300 K)
ERTJZET104□	100 kΩ		4500 K±2 %	(4550 K)
ERTJZEV104□	100 kΩ		4700 K±2 %	(4750 K)
ERTJZET154□	150 kΩ		4500 K±2 %	(4750 K)
ERTJZET224□	220 kΩ		4500 K±2 %	(4750 K)

□ : Resistance Tolerance Code

● 0402(EIA)

Part Number	Nominal Resistance at 25 °C	Resistance Tolerance	B Value at 25/50(K)	B Value at 25/85(K)
ERTJ0EA220□	22 Ω	±3 % (H) or ±5 % (J)	2750 K±3 %	(2700 K)
ERTJ0EA330□	33 Ω		2750 K±3 %	(2700 K)
ERTJ0EA400□	40 Ω		2750 K±3 %	(2700 K)
ERTJ0EA470□	47 Ω		2750 K±3 %	(2700 K)
ERTJ0EA680□	68 Ω		2800 K±3 %	(2750 K)
ERTJ0EA101□	100 Ω		2800 K±3 %	(2750 K)
ERTJ0EA151□	150 Ω		2800 K±3 %	(2750 K)
ERTJ0ET102□	1.0 kΩ		4500 K±2 %	(4450 K)
ERTJ0ET152□	1.5 kΩ		4500 K±2 %	(4450 K)
ERTJ0ET202□	2.0 kΩ		4500 K±2 %	(4450 K)
ERTJ0ET222□	2.2 kΩ		4500 K±2 %	(4450 K)
ERTJ0ET302□	3.0 kΩ		4500 K±2 %	(4450 K)
ERTJ0ER332□	3.3 kΩ		4250 K±2 %	(4300 K)
ERTJ0ET332□	3.3 kΩ		4500 K±2 %	(4450 K)
ERTJ0ET472□	4.7 kΩ		4500 K±2 %	(4450 K)
ERTJ0ER472□	4.7 kΩ		4250 K±2 %	(4300 K)
ERTJ0ER682□	6.8 kΩ		4250 K±2 %	(4300 K)
ERTJ0EG103□A	10 kΩ		(3380 K)	3435 K±1 %
ERTJ0EM103□	10 kΩ		3900 K±2 %	(3970 K)
ERTJ0ER103□	10 kΩ		4250 K±2 %	(4300 K)
ERTJ0ER153□	15 kΩ		4250 K±2 %	(4300 K)
ERTJ0ER223□	22 kΩ		4250 K±2 %	(4300 K)
ERTJ0EP333□	33 kΩ		4050 K±2 %	(4100 K)
ERTJ0ER333□	33 kΩ		4250 K±2 %	(4300 K)
ERTJ0ET333□	33 kΩ		4500 K±2 %	(4580 K)
ERTJ0EP473□	47 kΩ		4050 K±2 %	(4100 K)
ERTJ0ET473□	47 kΩ		4500 K±2 %	(4550 K)
ERTJ0EV473□	47 kΩ		4700 K±2 %	(4750 K)
ERTJ0EP683□	68 kΩ		4050 K±2 %	(4100 K)
ERTJ0ER683□	68 kΩ		4250 K±2 %	(4300 K)
ERTJ0EV683□	68 kΩ		4700 K±2 %	(4750 K)
ERTJ0EP104□	100 kΩ		4050 K±2 %	(4100 K)
ERTJ0ER104□	100 kΩ		4250 K±2 %	(4300 K)
ERTJ0ES104□	100 kΩ	4330 K±2 %	(4390 K)	
ERTJ0ET104□	100 kΩ	4500 K±2 %	(4580 K)	
ERTJ0EV104□	100 kΩ	4700 K±2 %	(4750 K)	
ERTJ0ET154□	150 kΩ	4500 K±2 %	(4580 K)	
ERTJ0EV154□	150 kΩ	4700 K±2 %	(4750 K)	
ERTJ0EV224□	220 kΩ	4700 K±2 %	(4750 K)	
ERTJ0EV334□	330 kΩ	4700 K±2 %	(4750 K)	
ERTJ0EV474□	470 kΩ	4700 K±2 %	(4750 K)	

□ : Resistance Tolerance Code

● 0603(EIA)

Part Number	Nominal Resistance at 25 °C	Resistance Tolerance	B Value at 25/50(K)	B Value at 25/85(K)
ERTJ1VA220□	22 Ω	±3 %(H) or ±5 %(J)	2750 K±3 %	(2700 K)
ERTJ1VA330□	33 Ω		2750 K±3 %	(2700 K)
ERTJ1VA400□	40 Ω		2800 K±3 %	(2750 K)
ERTJ1VA470□	47 Ω		2800 K±3 %	(2750 K)
ERTJ1VA680□	68 Ω		2800 K±3 %	(2750 K)
ERTJ1VA101□	100 Ω		2800 K±3 %	(2750 K)
ERTJ1VT102□	1.0 kΩ		4500 K±2 %	(4450 K)
ERTJ1VT152□	1.5 kΩ		4500 K±2 %	(4450 K)
ERTJ1VT202□	2.0 kΩ		4500 K±2 %	(4450 K)
ERTJ1VT222□	2.2 kΩ		4500 K±2 %	(4450 K)
ERTJ1VT302□	3.0 kΩ		4500 K±2 %	(4450 K)
ERTJ1VT332□	3.3 kΩ		4500 K±2 %	(4450 K)
ERTJ1VR332□	3.3 kΩ		4250 K±2 %	(4300 K)
ERTJ1VR472□	4.7 kΩ		4250 K±2 %	(4300 K)
ERTJ1VT472□	4.7 kΩ		4500 K±2 %	(4450 K)
ERTJ1VR682□	6.8 kΩ		4250 K±2 %	(4300 K)
ERTJ1VG103□A	10 kΩ		(3380 K)	3435 K±1%
ERTJ1VR103□	10 kΩ		4250 K±2 %	(4300 K)
ERTJ1VR153□	15 kΩ		4250 K±2 %	(4300 K)
ERTJ1VR223□	22 kΩ		4250 K±2 %	(4300 K)
ERTJ1VR333□	33 kΩ		4250 K±2 %	(4300 K)
ERTJ1VP473□	47 kΩ		4100 K±2 %	(4150 K)
ERTJ1VR473□	47 kΩ		4250 K±2 %	(4300 K)
ERTJ1VV473□	47 kΩ		4700 K±2 %	(4750 K)
ERTJ1VR683□	68 kΩ		4250 K±2 %	(4300 K)
ERTJ1VV683□	68 kΩ		4700 K±2 %	(4750 K)
ERTJ1VS104□A	100 kΩ		(4330 K)	4390 K±1%
ERTJ1VV104□	100 kΩ		4700 K±2 %	(4750 K)
ERTJ1VV154□	150 kΩ		4700 K±2 %	(4750 K)
ERTJ1VT224□	220 kΩ		4500 K±2 %	(4580 K)

□ : Resistance Tolerance Code

● Temperature and Resistance value (the resistance value at 25 °C is set to 1)/ Reference values

	ERTJ□□A~		ERTJ□□G~		ERTJ□□M~		ERTJ□□P~		ERTJ□□R~		ERTJ0ES~		ERTJ1VS~		ERTJ□□T~		ERTJ□□T~		ERTJ□□V~	
B <sub>25/50</sub>	2750 K	2800 K	(3375 K)	3900 K	4050 K	4250 K	4330 K	(4330 K)	4500 K	4500 K	4700 K									
B <sub>25/85</sub>	(2700 K)	(2750 K)	3435 K	(3970 K)	(4100 K)	(4300 K)	(4390 K)	4390 K	(4450 K)	(4580 K)	(4750 K)									
T(°C)															*1	*2				
-40	13.05	13.28	20.52	32.11	33.10	43.10	45.67	45.53	63.30	47.07	59.76									
-35	10.21	10.40	15.48	23.29	24.03	30.45	32.08	31.99	42.92	33.31	41.10									
-30	8.061	8.214	11.79	17.08	17.63	21.76	22.80	22.74	29.50	23.80	28.61									
-25	6.427	6.547	9.069	12.65	13.06	15.73	16.39	16.35	20.53	17.16	20.14									
-20	5.168	5.261	7.037	9.465	9.761	11.48	11.91	11.89	14.46	12.49	14.33									
-15	4.191	4.261	5.507	7.147	7.362	8.466	8.743	8.727	10.30	9.159	10.31									
-10	3.424	3.476	4.344	5.444	5.599	6.300	6.479	6.469	7.407	6.772	7.482									
-5	2.819	2.856	3.453	4.181	4.291	4.730	4.845	4.839	5.388	5.046	5.481									
0	2.336	2.362	2.764	3.237	3.312	3.582	3.654	3.650	3.966	3.789	4.050									
5	1.948	1.966	2.227	2.524	2.574	2.734	2.778	2.776	2.953	2.864	3.015									
10	1.635	1.646	1.806	1.981	2.013	2.102	2.128	2.126	2.221	2.179	2.262									
15	1.380	1.386	1.474	1.567	1.584	1.629	1.642	1.641	1.687	1.669	1.710									
20	1.171	1.174	1.211	1.247	1.255	1.272	1.277	1.276	1.293	1.287	1.303									
25	1	1	1	1	1	1	1	1	1	1	1									
30	0.8585	0.8565	0.8309	0.8072	0.8016	0.7921	0.7888	0.7890	0.7799	0.7823	0.7734									
35	0.7407	0.7372	0.6941	0.6556	0.6461	0.6315	0.6263	0.6266	0.6131	0.6158	0.6023									
40	0.6422	0.6376	0.5828	0.5356	0.5235	0.5067	0.5004	0.5007	0.4856	0.4876	0.4721									
45	0.5595	0.5541	0.4916	0.4401	0.4266	0.4090	0.4022	0.4025	0.3874	0.3884	0.3723									
50	0.4899	0.4836	0.4165	0.3635	0.3496	0.3319	0.3251	0.3254	0.3111	0.3111	0.2954									
55	0.4309	0.4238	0.3543	0.3018	0.2881	0.2709	0.2642	0.2645	0.2513	0.2504	0.2356									
60	0.3806	0.3730	0.3027	0.2518	0.2386	0.2222	0.2158	0.2161	0.2042	0.2026	0.1889									
65	0.3376	0.3295	0.2595	0.2111	0.1985	0.1832	0.1772	0.1774	0.1670	0.1648	0.1523									
70	0.3008	0.2922	0.2233	0.1777	0.1659	0.1518	0.1463	0.1465	0.1377	0.1348	0.1236									
75	0.2691	0.2600	0.1929	0.1504	0.1393	0.1264	0.1213	0.1215	0.1144	0.1108	0.1009									
80	0.2417	0.2322	0.1672	0.1278	0.1174	0.1057	0.1011	0.1013	0.09560	0.09162	0.08284									
85	0.2180	0.2081	0.1451	0.1090	0.09937	0.08873	0.08469	0.08486	0.08033	0.07609	0.06834									
90	0.1974	0.1871	0.1261	0.09310	0.08442	0.07468	0.07122	0.07138	0.06782	0.06345	0.05662									
95	0.1793	0.1688	0.1097	0.07980	0.07200	0.06307	0.06014	0.06028	0.05753	0.05314	0.04712									
100	0.1636	0.1528	0.09563	0.06871	0.06166	0.05353	0.05099	0.05112	0.04903	0.04472	0.03939									
105	0.1498	0.1387	0.08357	0.05947	0.05306	0.04568	0.04340	0.04351	0.04198	0.03784	0.03308									
110	0.1377	0.1263	0.07317	0.05170	0.04587	0.03918	0.03708	0.03718	0.03609	0.03218	0.02791									
115	0.1270	0.1153	0.06421	0.04512	0.03979	0.03374	0.03179	0.03188	0.03117	0.02748	0.02364									
120	0.1175	0.1056	0.05650	0.03951	0.03460	0.02916	0.02734	0.02742	0.02702	0.02352	0.02009									
125	0.1091	0.09695	0.04986	0.03470	0.03013	0.02527	0.02359	0.02367	0.02351	0.02017	0.01712									

\*1 Apply to products with a B<sub>25/50</sub> constant of 4500 K and a resistance value of 25 °C less than 10 kΩ. \*2 Applied only to ERTJ0ET104□.

\*2 Apply to products with a B<sub>25/50</sub> constant of 4500 K and a resistance value of 25 °C of 10 kΩ or more. \*2 Applied only to ERTJ0ET104□.

$$B_{25/50} = \frac{\ln(R_{25}/R_{50})}{1/298.15 - 1/323.15}$$

$$B_{25/85} = \frac{\ln(R_{25}/R_{85})}{1/298.15 - 1/358.15}$$

R<sub>25</sub>=Resistance at 25.0±0.1 °C

R<sub>50</sub>=Resistance at 50.0±0.1 °C

R<sub>85</sub>=Resistance at 85.0±0.1 °C

## Specification and Test Method

Item	Specification	Test Method																		
Rated Zero-power Resistance (R <sub>25</sub> )	Within the specified tolerance.	The value is measured at a power that the influence of self-heat generation can be negligible (0.1mW or less), at the rated ambient temperature of 25.0±0.1°C.																		
B Value	Shown in each Individual Specification. * Individual Specification shall specify B <sub>25/50</sub> or B <sub>25/85</sub> .	<p>The Zero-power resistances; R<sub>1</sub> and R<sub>2</sub>, shall be measured respectively at T<sub>1</sub> (deg.C) and T<sub>2</sub> (deg.C). The B value is calculated by the following equation.</p> $B_{T_1/T_2} = \frac{\ln(R_1) - \ln(R_2)}{1/(T_1 + 273.15) - 1/(T_2 + 273.15)}$ <table border="1"> <thead> <tr> <th></th> <th>T<sub>1</sub></th> <th>T<sub>2</sub></th> </tr> </thead> <tbody> <tr> <td>B<sub>25/50</sub></td> <td>25.0 ±0.1 °C</td> <td>50.0 ±0.1 °C</td> </tr> <tr> <td>B<sub>25/85</sub></td> <td>25.0 ±0.1 °C</td> <td>85.0 ±0.1 °C</td> </tr> </tbody> </table>		T <sub>1</sub>	T <sub>2</sub>	B <sub>25/50</sub>	25.0 ±0.1 °C	50.0 ±0.1 °C	B <sub>25/85</sub>	25.0 ±0.1 °C	85.0 ±0.1 °C									
	T <sub>1</sub>	T <sub>2</sub>																		
B <sub>25/50</sub>	25.0 ±0.1 °C	50.0 ±0.1 °C																		
B <sub>25/85</sub>	25.0 ±0.1 °C	85.0 ±0.1 °C																		
Adhesion	The terminal electrode shall be free from peeling or signs of peeling.	<p>Applied force : Size 0201 : 2 N Size 0402, 0603 : 5 N Duration : 10 s</p> <p>Size : 0201, 0402</p>  <p>Size : 0603</p>  <p>Unit : mm</p>																		
Bending Strength	There shall be no cracks and other mechanical damage. R <sub>25</sub> change : within ±5 %	<p>Bending distance : 1 mm Bending speed : 1 mm/s</p>  <p>Unit : mm</p>																		
Resistance to Soldering Heat	There shall be no cracks and other mechanical damage. <table border="0"> <tr> <td></td> <td>Narrow Tol. type</td> <td>Standard type</td> </tr> <tr> <td>R<sub>25</sub> change</td> <td>: within ±2 %</td> <td>within ±3 %</td> </tr> <tr> <td>B Value change</td> <td>: within ±1 %</td> <td>within ±2 %</td> </tr> </table>		Narrow Tol. type	Standard type	R <sub>25</sub> change	: within ±2 %	within ±3 %	B Value change	: within ±1 %	within ±2 %	<p>Soldering bath method Solder temperature : 270 ±5 °C Dipping period : 4.0 ±1 s Preheat condition :</p> <table border="1"> <thead> <tr> <th>Step</th> <th>Temp (°C)</th> <th>Period (s)</th> </tr> </thead> <tbody> <tr> <td>1</td> <td>80 to 100</td> <td>120 to 180</td> </tr> <tr> <td>2</td> <td>150 to 200</td> <td>120 to 180</td> </tr> </tbody> </table>	Step	Temp (°C)	Period (s)	1	80 to 100	120 to 180	2	150 to 200	120 to 180
	Narrow Tol. type	Standard type																		
R <sub>25</sub> change	: within ±2 %	within ±3 %																		
B Value change	: within ±1 %	within ±2 %																		
Step	Temp (°C)	Period (s)																		
1	80 to 100	120 to 180																		
2	150 to 200	120 to 180																		
Solderability	More than 95 % of the soldered area of both terminal electrodes shall be covered with fresh solder.	<p>Soldering bath method Solder temperature : 230 ±5 °C Dipping period : 4 ±1 s Solder : Sn-3.0Ag-0.5Cu</p>																		

## Specification and Test Method

Item	Specification		Test Method
Temperature Cycling	Narrow Tol. type R <sub>25</sub> change : within ±2 % B Value change : within ±1 %	Standard type within ±3 % within ±2 %	Conditions of one cycle Step 1 : -40 °C, 30±3 min Step 2 : Room temp., 3 min max. Step 3 : 125 °C, 30±3 min. Step 4 : Room temp., 3 min max. Number of cycles: 100 cycles
Humidity	Narrow Tol. type R <sub>25</sub> change : within ±2 % B Value change : within ±1 %	Standard type within ±3 % within ±2 %	Temperature : 85 ±2 °C Relative humidity : 85 ±5 % Test period : 1000 +48/0 h
Biased Humidity	Narrow Tol. type R <sub>25</sub> change : within ±2 % B Value change : within ±1 %	Standard type within ±3 % within ±2 %	Temperature : 85 ±2 °C Relative humidity : 85 ±5 % Applied power : 10 mW(D.C.) Test period : 500 +48/0 h
Low Temperature Exposure	Narrow Tol. type R <sub>25</sub> change : within ±2 % B Value change : within ±1 %	Standard type within ±3 % within ±2 %	Specimens are soldered on the testing board shown in Fig.2. Temperature : -40 ±3 °C Test period : 1000 +48/0 h
High Temperature Exposure	Narrow Tol. type R <sub>25</sub> change : within ±2 % B Value change : within ±1 %	Standard type within ±3 % within ±2 %	Specimens are soldered on the testing board shown in Fig.2. Temperature : 125 ±3 °C Test period : 1000 +48/0 h

## Typical Application

### ● Temperature Detection

Writing current control of HDD

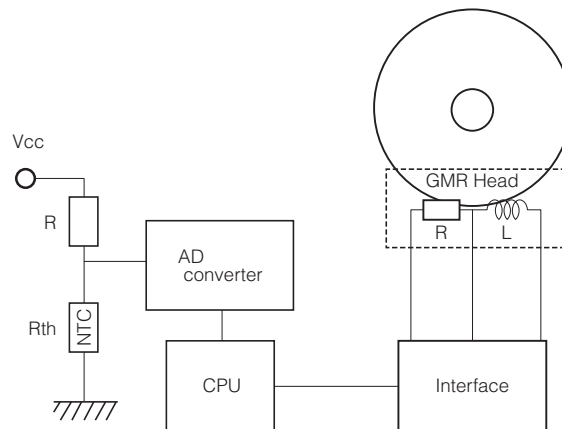

### ● Temperature Compensation (Pseudo-linearization)

Contrast level control of LCD

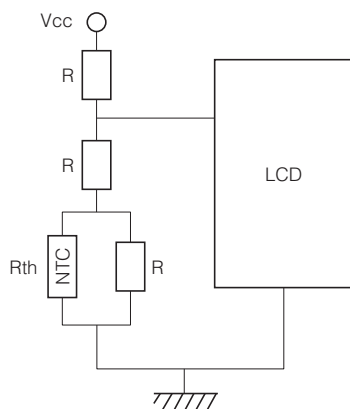

### ● Temperature Compensation (RF circuit)

Temperature compensation of TCXO



## Dimensions in mm (not to scale)

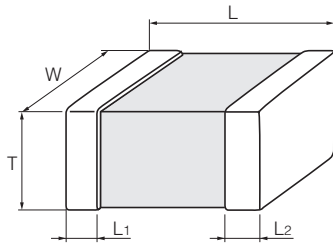

(Unit : mm)

Size Code (EIA)	L	W	T	L <sub>1</sub> , L <sub>2</sub>
Z(0201)	0.60±0.03	0.30±0.03	0.30±0.03	0.15±0.05
0(0402)	1.0±0.1	0.50±0.05	0.50±0.05	0.25±0.15
1(0603)	1.60±0.15	0.8±0.1	0.8±0.1	0.3±0.2

## Packaging Methods

### ● Standard Packing Quantities

Size Code	Thickness (mm)	Kind of Taping	Pitch (mm)	Quantity (pcs./reel)
Z(0201)	0.3	Pressed Carrier Taping	2	15,000
0(0402)	0.5	Punched Carrier Taping	2	10,000
1(0603)	0.8		4	4,000

### ● Pitch 2 mm (Pressed Carrier Taping) : Size 0201

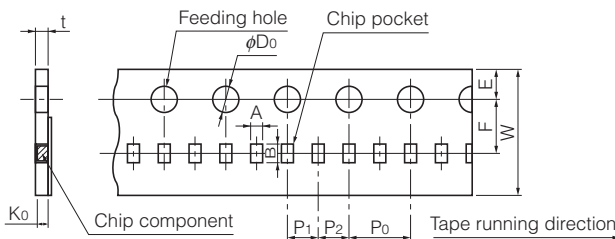

Symbol	A	B	W	F	E	P <sub>1</sub>	P <sub>2</sub>	P <sub>0</sub>	φD <sub>0</sub>	t	K <sub>0</sub>
Dim. (mm)	0.36 ±0.03	0.66 ±0.03	8.0 ±0.2	3.50 ±0.05	1.75 ±0.10	2.00 ±0.05	2.00 ±0.05	4.0 ±0.1	1.5 <sup>+0.1</sup> <sub>0</sub>	0.55 max.	0.36 ±0.03

### ● Pitch 2 mm (Punched Carrier Taping) : Size 0402

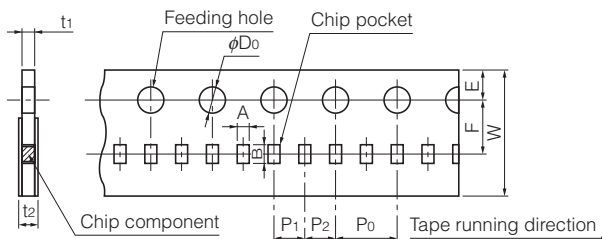

Symbol	A	B	W	F	E	P <sub>1</sub>	P <sub>2</sub>	P <sub>0</sub>	φD <sub>0</sub>	t <sub>1</sub>	t <sub>2</sub>
Dim. (mm)	0.62 ±0.05	1.12 ±0.05	8.0 ±0.2	3.50 ±0.05	1.75 ±0.10	2.00 ±0.05	2.00 ±0.05	4.0 ±0.1	1.5 <sup>+0.1</sup> <sub>0</sub>	0.7 max.	1.0 max.

### ● Pitch 4 mm (Punched Carrier Taping) : Size 0603

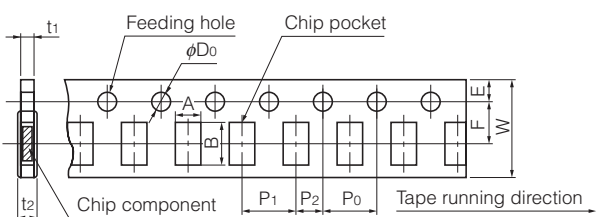

Symbol	A	B	W	F	E	P <sub>1</sub>	P <sub>2</sub>	P <sub>0</sub>	φD <sub>0</sub>	t <sub>1</sub>	t <sub>2</sub>
Dim. (mm)	1.0 ±0.1	1.8 ±0.1	8.0 ±0.2	3.50 ±0.05	1.75 ±0.10	4.0 ±0.1	2.00 ±0.05	4.0 ±0.1	1.5 <sup>+0.1</sup> <sub>0</sub>	1.1 max.	1.4 max.

### ● Reel for Taping

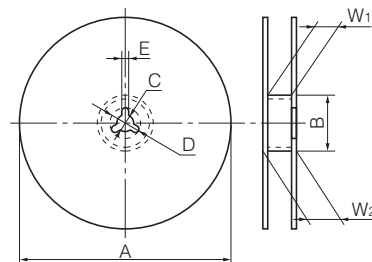

Symbol	φA	φB	C	D	E	W <sub>1</sub>	W <sub>2</sub>
Dim. (mm)	180 <sup>-0.3</sup>	60.0 <sup>+1.0</sup> <sub>0</sub>	13.0±0.5	21.0±0.8	2.0±0.5	9.0 <sup>+1.0</sup> <sub>0</sub>	11.4±1.0

### ● Leader Part and Taped End

#### Leader part

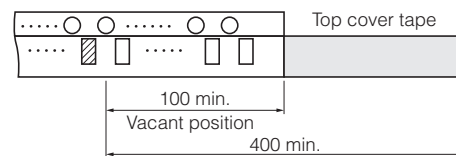

#### Taped end

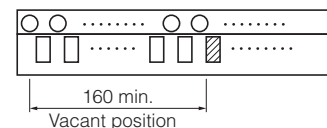

(Unit : mm)

## Minimum Quantity / Packing Unit

Part Number (Size)	Minimum Quantity / Packing Unit	Packing Quantity in Carton	Carton L×W×H (mm)
ERTJZ (0201)	15,000	300,000	250×200×200
ERTJ0 (0402)	10,000	200,000	250×200×200
ERTJ1 (0603)	4,000	80,000	250×200×200

Part No., quantity and country of origin are designated on outer packages in English.



**Guidelines and precautions regarding the technical information and use of our products described in this online catalog.**

- If you want to use our products described in this online catalog for applications requiring special qualities or reliability, or for applications where the failure or malfunction of the products may directly jeopardize human life or potentially cause personal injury (e.g. aircraft and aerospace equipment, traffic and transportation equipment, combustion equipment, medical equipment, accident prevention, anti-crime equipment, and/or safety equipment), it is necessary to verify whether the specifications of our products fit to such applications. Please ensure that you will ask and check with our inquiry desk as to whether the specifications of our products fit to such applications use before you use our products.
- The quality and performance of our products as described in this online catalog only apply to our products when used in isolation. Therefore, please ensure you evaluate and verify our products under the specific circumstances in which our products are assembled in your own products and in which our products will actually be used.
- If you use our products in equipment that requires a high degree of reliability, regardless of the application, it is recommended that you set up protection circuits and redundancy circuits in order to ensure safety of your equipment.
- The products and product specifications described in this online catalog are subject to change for improvement without prior notice. Therefore, please be sure to request and confirm the latest product specifications which explain the specifications of our products in detail, before you finalize the design of your applications, purchase, or use our products.
- The technical information in this online catalog provides examples of our products' typical operations and application circuits. We do not guarantee the non-infringement of third party's intellectual property rights and we do not grant any license, right, or interest in our intellectual property.
- If any of our products, product specifications and/or technical information in this online catalog is to be exported or provided to non-residents, the laws and regulations of the exporting country, especially with regard to security and export control, shall be observed.

**<Regarding the Certificate of Compliance with the EU RoHS Directive/REACH Regulations>**

- The switchover date for compliance with the RoHS Directive/REACH Regulations varies depending on the part number or series of our products.
- When you use the inventory of our products for which it is unclear whether those products are compliant with the RoHS Directive/REACH Regulation, please select "Sales Inquiry" in the website inquiry form and contact us.

**We do not take any responsibility for the use of our products outside the scope of the specifications, descriptions, guidelines and precautions described in this online catalog.**

## Multilayer NTC Thermistors

Series: ERTJ

### Handling Precautions

#### [Precautions]

- **Do not use the products beyond the descriptions in this product catalog.**
- **This product catalog guarantees the quality of the products as individual components. Before you use the products, please make sure to check and evaluate the products in the circumstance where they are installed in your product.**

#### Safety Precautions

Multilayer NTC Thermistors for General Applications (hereafter referred to as "Thermistors") are intended to be used in general-purpose applications as measures against Temperature detection and Temperature compensation in consumer electronics (audio/visual, home, office, information & communication) equipment. When subjected to severe electrical, environmental, and/or mechanical stress beyond the specifications, as noted in the Ratings and Specified Conditions section, the Thermistors' performance may be degraded, or become failure mode, such as short circuit mode and open-circuit mode.

If you use under the condition of short-circuit, heat generation of Thermistors will occur by running large current due to application of voltage. There are possibilities of smoke emission, substrate burn-out, and, in the worst case, fire. For products which require high safety levels, please carefully consider how a single malfunction can affect your product. In order to ensure the safety in the case of a single malfunction, please design products with fail-safe, such as setting up protecting circuits, etc.

We are trying to improve the quality and the reliability, but the durability differs depending on the use environment and the use conditions. On use, be sure to confirm the actual product under the actual use conditions.

- For the following applications and conditions, please be sure to consult with our sales representative in advance and to exchange product specifications which conform to such applications.
  - When your application may have difficulty complying with the safety or handling precautions specified below.
  - High-quality and high-reliability required devices that have possibility of causing hazardous conditions, such as death or injury (regardless of directly or indirectly), due to failure or malfunction of the product.
    - ① Aircraft and Aerospace Equipment (artificial satellite, rocket, etc.)
    - ② Submarine Equipment (submarine repeating equipment, etc.)
    - ③ Transportation Equipment (motor vehicles, airplanes, trains, ship, traffic signal controllers, etc.)
    - ④ Power Generation Control Equipment  
(atomic power, hydroelectric power, thermal power plant control system, etc.)
    - ⑤ Medical Equipment (life-support equipment, pacemakers, dialysis controllers, etc.)
    - ⑥ Information Processing Equipment (large scale computer systems, etc.)
    - ⑦ Electric Heating Appliances, Combustion devices (gas fan heaters, oil fan heaters, etc.)
    - ⑧ Rotary Motion Equipment
    - ⑨ Security Systems
    - ⑩ And any similar types of equipment

#### Strict Observance

##### 1. Confirmation of Rated Performance

The Thermistors shall be operated within the specified rating/performance.

Applications exceeding the specifications may cause deteriorated performance and/or breakdown, resulting in degradation and/or smoking or ignition of products. The following are strictly observed.

- (1) The Thermistors shall not be operated beyond the specified operating temperature range.
- (2) The Thermistors shall not be operated in excess of the specified maximum power dissipation.

##### 2. The Thermistors shall not be mounted near flammables.

## Operating Conditions and Circuit Design

### 1. Circuit Design

#### 1.1 Operating Temperature and Storage Temperature

When operating a components-mounted circuit, please be sure to observe the "Operating Temperature Range", written in delivery specifications. Storage temperature of PCB after mounting Thermistors, which is not operated, should be within the specified "Storage Temperature Range" in the delivery specifications. Please remember not to use the product under the condition that exceeds the specified maximum temperature.

#### 1.2 Operating Power

The electricity applied to between terminals of Thermistors should be under the specified maximum power dissipation. There are possibilities of breakage and burn-out due to excessive self-heating of Thermistors, if the power exceeds maximum power dissipation when operating. Please consider installing protection circuit for your circuit to improve the safety, in case of abnormal voltage application and so on. Thermistors' performance of temperature detection would be deteriorated if self-heating occurs, even when you use it under the maximum power dissipation. Please consider the maximum power dissipation and dissipation factor.

#### 【Maximum power dissipation】

- The Maximum power that can be continuously applied under static air at a certain ambient temperature. The Maximum power dissipation under an ambient temperature of 25 °C or less is the same with the rated maximum power dissipation, and Maximum power dissipation beyond 25 °C depends on the Decreased power dissipation curve below.

#### 【Dissipation factor】

- The constant amount power required to raise the temperature of the Thermistor 1 °C through self heat generation under stable temperatures.  
Dissipation factor (mW/°C) = Power consumption of Thermistor / Temperature rise of element.



#### 1.3 Environmental Restrictions

The Thermistors does not take the use under the following special environments into consideration. Accordingly, the use in the following special environments, and such environmental conditions may affect the performance of the product; prior to use, verify the performance, reliability, etc. thoroughly.

- ① Use in liquids such as water, oil, chemical, and organic solvent.
- ② Use under direct sunlight, in outdoor or in dusty atmospheres.
- ③ Use in places full of corrosive gases such as sea breeze, Cl<sub>2</sub>, H<sub>2</sub>S, NH<sub>3</sub>, SO<sub>2</sub>, and NO<sub>x</sub>.
- ④ Use in environment with large static electricity or strong electromagnetic waves or strong radial ray.
- ⑤ Where the product is close to a heating component, or where an inflammable such as a polyvinyl chloride wire is arranged close to the product.
- ⑥ Where this product is sealed or coated with resin etc.
- ⑦ Where solvent, water, or water-soluble detergent is used in flux cleaning after soldering.  
(Pay particular attention to water-soluble flux.)
- ⑧ Use in such a place where the product is wetted due to dew condensation.
- ⑨ Use the product in a contaminated state.  
Ex.) Do not handle the product such as sticking sebum directly by touching the product after mounting printed circuit board.
- ⑩ Under severe conditions of vibration or impact beyond the specified conditions found in the Specifications.

#### 1.4 Measurement of Resistance

The resistance of the Thermistors varies depending on ambient temperatures and self-heating. To measure the resistance value when examining circuit configuration and conducting receiving inspection and so on, the following points should be taken into consideration:

- ① Measurement temp : 25±0.1 °C  
Measurement in liquid (silicon oil, etc.) is recommended for a stable measurement temperature.
- ② Power : 0.10 mW max. 4 terminal measurement with a constant-current power supply is recommended.

**2. Design of Printed Circuit Board**

**2.1 Selection of Printed Circuit Boards**

There is a possibility of performance deterioration by heat shock (temperature cycles), which causes cracks, from alumina substrate. Please confirm that the substrate you use does not deteriorate the Thermistors' quality.

**2.2 Design of Land Pattern**

(1) Recommended land dimensions are shown below. Use the proper amount of solder in order to prevent cracking. Using too much solder places excessive stress on the Thermistors..

Recommended Land Dimensions(Ex.)

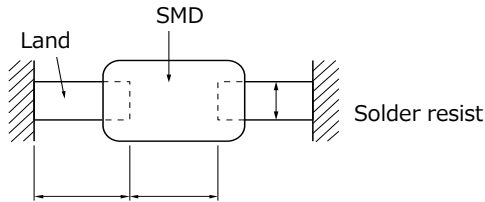

Size Code/EIA	Component dimensions			Unit (mm)		
	L	W	T	a	b	c
Z(0201)	0.6	0.3	0.3	0.2 to 0.3	0.25 to 0.30	0.2 to 0.3
0(0402)	1.0	0.5	0.5	0.4 to 0.5	0.4 to 0.5	0.4 to 0.5
1(0603)	1.6	0.8	0.8	0.8 to 1.0	0.6 to 0.8	0.6 to 0.8

(2) The land size shall be designed to have equal space, on both right and left side. If the amount of solder on both sides is not equal, the component may be cracked by stress since the side with a larger amount of solder solidifies later during cooling.

**Recommended Amount of Solder**

(a) Excessive amount    (b) Proper amount    (c) Insufficient amount



**2.3 Utilization of Solder Resist**

(1) Solder resist shall be utilized to equalize the amounts of solder on both sides.

- (2) Solder resist shall be used to divide the pattern for the following cases;
- Components are arranged closely.
  - The Thermistor is mounted near a component with lead wires.
  - The Thermistor is placed near a chassis.

Refer to the table below.

**Prohibited Applications and Recommended Applications**

Item	Prohibited applications	Improved applications by pattern division
Mixed mounting with a component with lead wires	The lead wire of a Component With lead wires 	Solder resist 
Arrangement near chassis	Chassis Solder(ground solder) Electrode pattern 	Solder resist 
Retro-fitting of component with lead wires	A lead wire of Retrofitted component Soldering iron iron 	Solder resist 
Lateral arrangement	Portion to be Excessively soldered Land 	Solder resist 

**2.4 Component Layout**

To prevent the crack of Thermistors, try to place it place it on the position that could not easily be affected by the bending stress of substrate while mounting procedures or procedures afterwards. Placement of the Thermistors near heating elements also requires the great care to be taken in order to avoid stresses from rapid heating and cooling.

- (1) To minimize mechanical stress caused by the warp or bending of a PC board, please follow the recommended Thermistors' layout below.

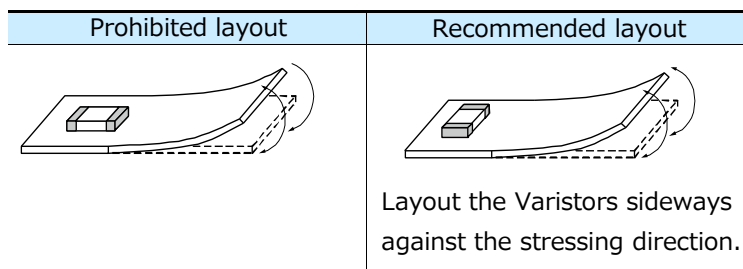

- (2) The following layout is for your reference since mechanical stress near the dividing/breaking position of a PC board varies depending on the mounting position of the Thermistors.

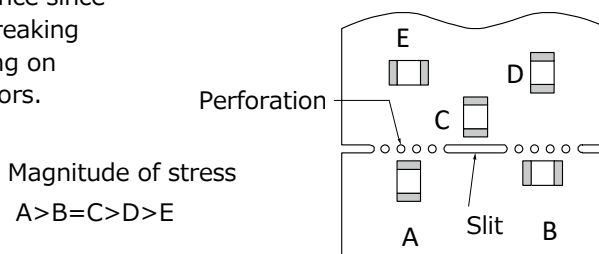

- (3) The magnitude of mechanical stress applied to the Thermistors when dividing the circuit board in descending order is as follows: push back < slit < V-groove < perforation. Also take into account the layout of the Thermistors and the dividing/breaking method.
- (4) When the Thermistors are placed near heating elements such as heater, etc., cracks from thermal stresses may occur under following situation:
- Soldering the Thermistors directly to heating elements.
  - Sharing the land with heating elements.
- If planning to conduct above-mentioned mounting and/or placement, please contact us in advance.

## 2.5 Mounting Density and Spaces

Intervals between components should not be too narrow to prevent the influence from solder bridges and solder balls. The space between components should be carefully determined.

## Precautions for Assembly

### 1. Storage

- (1) The Thermistors shall be stored between 5 to 40 °C and 20 to 70 % RH, not under severe conditions of high temperature and humidity.
- (2) If stored in a place where humidity, dust, or corrosive gasses (hydrogen sulfide, sulfurous acid, hydrogen chloride and ammonia, etc.) are contained, the solderability of terminals electrodes will be deteriorated. In addition, storage in a place where the heat or direct sunlight exposure occurs will causes or direct sunlight exposure occurs will causes mounting problems due to deformation of tapes and reels and components and taping/reels sticking together.
- (3) Do not store components longer than 6 months. Check the solderability of products that have been stored for more than 6 months before use.

### 2. Chip Mounting Consideration

- (1) When mounting the Thermistors/components on a PC board, the Thermistor bodies shall be free from excessive impact loads such as mechanical impact or stress due to the positioning, pushing force and displacement of vacuum nozzles during mounting.
- (2) Maintenance and inspection of the Chip Mounter must be performed regularly.
- (3) If the bottom dead center of the vacuum nozzle is too low, the Thermistor will crack from excessive force during mounting. The following precautions and recommendations are for your reference in use.
  - (a) Set and adjust the bottom dead center of the vacuum nozzles to the upper surface of the PC board after correcting the warp of the PC board.
  - (b) Set the pushing force of the vacuum nozzle during mounting to 1 to 3 N in static load.
  - (c) For double surface mounting, apply a supporting pin on the rear surface of the PC board to suppress the bending of the PC board in order to minimize the impact of the vacuum nozzles. Typical examples are shown in the table below.
  - (d) Adjust the vacuum nozzles so that their bottom dead center during mounting is not too low.

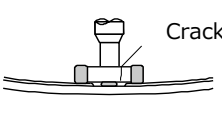
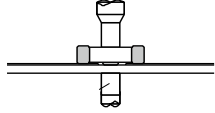
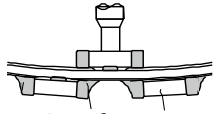
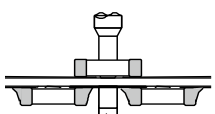
Item	Prohibited mounting	Recommended mounting
Single surface mounting	 Crack	 Supporting pin The supporting pin does not necessarily have to be positioned
Double surface mounting	 Separation of solder Crack	 Supporting pin

- (4) The closing dimensions of the positioning chucks shall be controlled. Maintenance and replacement of positioning chucks shall be performed regularly to prevent chipping or cracking of the Thermistors caused by mechanical impact during positioning due to worn positioning chucks.
- (5) Maximum stroke of the nozzle shall be adjusted so that the maximum bending of PC board does not exceed 0.5 mm at 90 mm span. The PC board shall be supported by an adequate number of supporting pins.

### 3. Selection of Soldering Flux

Soldering flux may seriously affect the performance of the Thermistors. The following shall be confirmed before use.

- (1) The soldering flux should have a halogen based content of 0.1 wt% (converted to chlorine) or below. Do not use soldering flux with strong acid.
- (2) When applying water-soluble soldering flux, wash the Thermistors sufficiently because the soldering flux residue on the surface of PC boards may deteriorate the insulation resistance on the Thermistors' surface.

### 4. Soldering

#### 4.1 Reflow Soldering

The reflow soldering temperature conditions are composed of temperature curves of Preheating, Temp. rise, Heating, Peak and Gradual cooling. Large temperature difference inside the Thermistors caused by rapid heat application to the Thermistors may lead to excessive thermal stresses, contributing to the thermal cracks. The Preheating temperature requires controlling with great care so that tombstone phenomenon may be prevented.

Recommended profile of Reflow Soldering (Ex.)

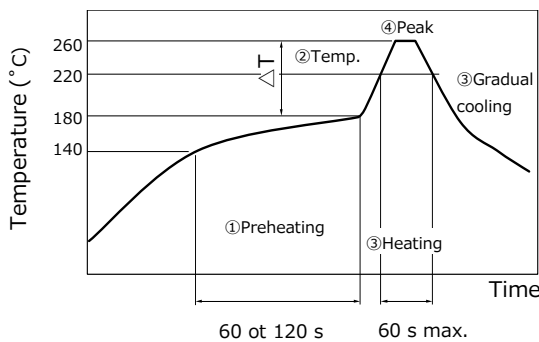

Item	Temperature	Period or Speed
① Preheating	140 to 180 °C	60 to 120 s
② Temp. rise	Preheating temp to Peak temp.	2 to 5 °C / s
③ Heating	220 °C min.	60 s max.
④ Peak	260 °C max.	10 s max.
⑤ Gradual cooling	Peak temp. to 140 °C	1 to 4 °C / s

$\Delta T$  : Allowable temperature difference  $\Delta T \leq 150$  °C

The rapid cooling (forced cooling) during Gradual cooling part should be avoided, because this may cause defects such as the thermal cracks, etc. When the Thermistors are immersed into a cleaning solvent, make sure that the surface temperatures of the devices do not exceed 100 °C. Performing reflow soldering twice under the conditions shown in the figure above [Recommended profile of Flow soldering (Ex.)] will not cause any problems. However, pay attention to the possible warp and bending of the PC board.

Recommended soldering condition is for the guideline for ensuring the basic characteristics of the components, not for the stable soldering conditions. Conditions for proper soldering should be set up according to individual conditions. The temperature of this product at the time of mounting changes depending on mounting conditions, therefore, please confirm that Product surface becomes the specified temperature when mounting it on the end product.

## 4.2 Hand Soldering

Hand soldering typically causes significant temperature change, which may induce excessive thermal stresses inside the Thermistors, resulting in the thermal cracks, etc. In order to prevent any defects, the following should be observed.

- The temperature of the soldering tips should be controlled with special care.
- The direct contact of soldering tips with the Thermistors and/or terminal electrodes should be avoided.
- Dismounted Thermistors shall not be reused.

### (1) Condition 1 (with preheating)

- Soldering : Use thread solder ( $\phi$  1.0 mm or below) which contains flux with low chlorine, developed for precision electronic equipment.
- Preheating : Conduct sufficient pre-heating, and make sure that the temperature difference between solder and Thermistors' surface is 150 °C or less.
- Temperature of Iron tip: 300 °C max.  
(The required amount of solder shall be melted in advance on the soldering tip.)
- Gradual cooling : After soldering, the Thermistors shall be cooled gradually at room temperature.

Recommended profile of Hand soldering (Ex.)

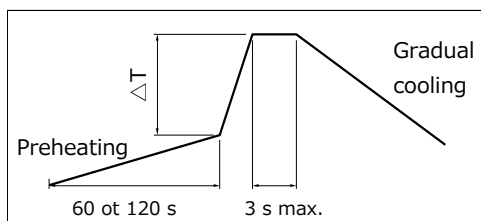

$\Delta T$  : Allowable temperature difference  $\Delta T \leq 150$  °C

### (2) Condition 2 (without preheating)

Hand soldering can be performed without preheating, by following the conditions below:

- Soldering iron tip shall never directly touch the ceramic and terminal electrodes of the Thermistors.
- The lands are sufficiently preheated with a soldering iron tip before sliding the soldering iron tip to the terminal electrodes of the Thermistors for soldering.

Conditions of Hand soldering without preheating

Item	Condition
Temperature of Iron tip	270 °C max.
Wattage	20 W max.
Shape of Iron tip	$\phi$ 3 mm max.
Soldering time with a soldering iron	3 s max.

## 5. Post Soldering Cleaning

### 5.1 Cleaning solvent

Soldering flux residue may remain on the PC board if cleaned with an inappropriate solvent. This may deteriorate the electrical characteristics and reliability of the Thermistors.

### 5.2 Cleaning conditions

Inappropriate cleaning conditions such as insufficient cleaning or excessive cleaning may impair the electrical characteristics and reliability of the Thermistors.

#### (1) Insufficient cleaning can lead to :

- The halogen substance found in the residue of the soldering flux may cause the metal of terminal electrodes to corrode.
- The halogen substance found in the residue of the soldering flux on the surface of the Thermistors may change resistance values.
- Water-soluble soldering flux may have more remarkable tendencies of (a) and (b) above compared to those of rosin soldering flux.

#### (2) Excessive cleaning can lead to :

- When using ultrasonic cleaner, make sure that the output is not too large, so that the substrate will not resonate. The resonance causes the cracks in Thermistors and/or solders, and deteriorates the strength of the terminal electrodes. Please follow these conditions for Ultrasonic cleaning:
  - Ultrasonic wave output : 20 W/L max.
  - Ultrasonic wave frequency : 40 kHz max.
  - Ultrasonic wave cleaning time : 5 min. max.

**5.3 Contamination of Cleaning solvent**

Cleaning with contaminated cleaning solvent may cause the same results as that of insufficient cleaning due to the high density of liberated halogen.

**6. Inspection Process**

The pressure from measuring terminal pins might bend the PCB when implementing circuit inspection after mounting Thermistors on PCB, and as a result, cracking may occur.

- (1) Mounted PC boards shall be supported by an adequate number of supporting pins on the back with bend settings of 90 mm span 0.5 mm max.
- (2) Confirm that the measuring pins have the right tip shape, are equal in height, have the right pressure and are set in the correct positions. The following figures are for your reference to avoid bending the PC board.

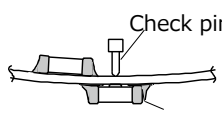
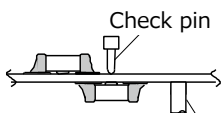
Item	Prohibited mounting	Recommended mounting
Bending of PC board	 <p>Separated, Crack</p>	 <p>Supporting pin</p>

**7. Protective Coating**

Make sure characteristics and reliability when using the resin coating or resin embedding for the purpose of improvement of humidity resistance or gas resistance, or fixing of parts because failures of a thermistors such as 1) ,2) and 3) may be occurred.

- (1) The solvent which contained in the resin permeate into the Thermistors, and it may deteriorate the characteristic.
- (2) When hardening the resin, chemical reaction heat (curing heat generation) happen and it may occurs the infection to the Thermistors.
- (3) The lead wire might be cut down and the soldering crack might be happen by expansion or contraction of resin hardening.

**8. Dividing/Breaking of PC Boards**

- (1) Please be careful not to stress the substrate with bending/twisting when dividing, after mounting components including Thermistors. Abnormal and excessive mechanical stress such as bending or torsion shown below can cause cracking in the Thermistors.

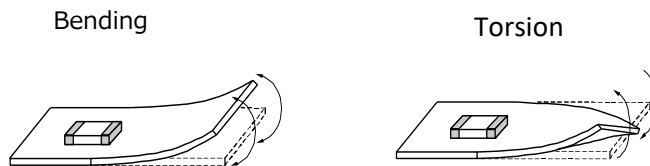

- (2) Dividing/Breaking of the PC boards shall be done carefully at moderate speed by using a jig or apparatus to prevent the Thermistors on the boards from mechanical damage.
- (3) Examples of PCB dividing/breaking jigs: The outline of PC board breaking jig is shown below. When PC board are broken or divided, loading points should be close to the jig to minimize the extent of the bending. Also, planes with no parts mounted on should be used as plane of loading, in order to prevent tensile stress induced by the bending, which may cause cracks of the Thermistors or other parts mounted on the PC boards.

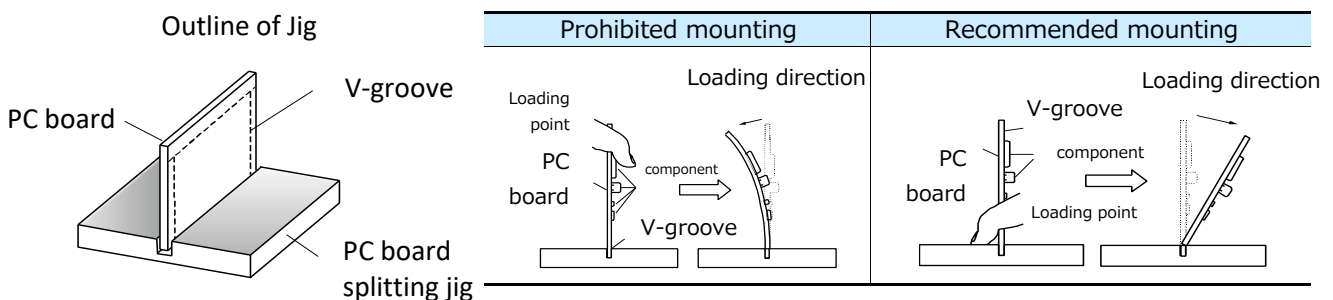



## 10. Mechanical Impact

- (1) The Thermistors shall be free from any excessive mechanical impact.

The Thermistor body is made of ceramics and may be damaged or cracked if dropped. Never use a Thermistor which has been dropped; their quality may already be impaired, and in that case, failure rate will increase.

- (2) When handling PC boards with Thermistors mounted on them, do not allow the Thermistors to collide with another PC board.

When mounted PC boards are handled or stored in a stacked state, the corner of a PC board might strike Thermistors, and the impact of the strike may cause damage or cracking and can deteriorate the withstand voltage and insulation resistance of the Thermistors.

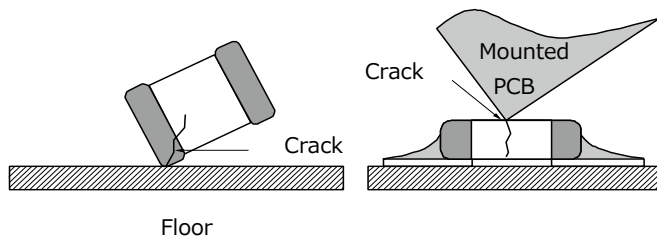

11. Do not reuse this product after removal from the mounting board.

## Precautions for discarding

As to the disposal of the Thermistors, check the method of disposal in each country or region where the modules are incorporated in your products to be used.

## Other

The Thermistors precautions described above are typical. For special mounting conditions, please contact us. The technical information in this catalog provides example of our products' typical operations and application circuit.

## Applicable laws and regulations , others

1. This product not been manufactured with any ozone depleting chemical controlled under the Montreal Protocol.
2. This product comply with RoHS(Restriction of the use of certain Hazardous Substance in electrical and electronic equipment) (DIRECTIVE 2011/65/EU and 2015/863/EU).
3. All the materials used in this part are registered material under the Law Concerning the Examination and Regulation of Manufacture, etc. of Chemical Substance.
4. If you need the notice by letter of "A preliminary judgement on the Laws of Japan foreign exchange and Foreign Trade Control", be sure to let us know.
5. These products are not dangerous goods on the transportation as identified by UN (United nations) numbers or UN classification.
6. The technical information in this catalog provides example of our products' typical operations and application circuit. We do not guarantee the non-infringement of third party's intellectual property rights and we do not grant any license, Right or interest in our intellectual property.